

IED GLOBALCOM

Installation Instructions IED Announcement Control System

IED1112PS

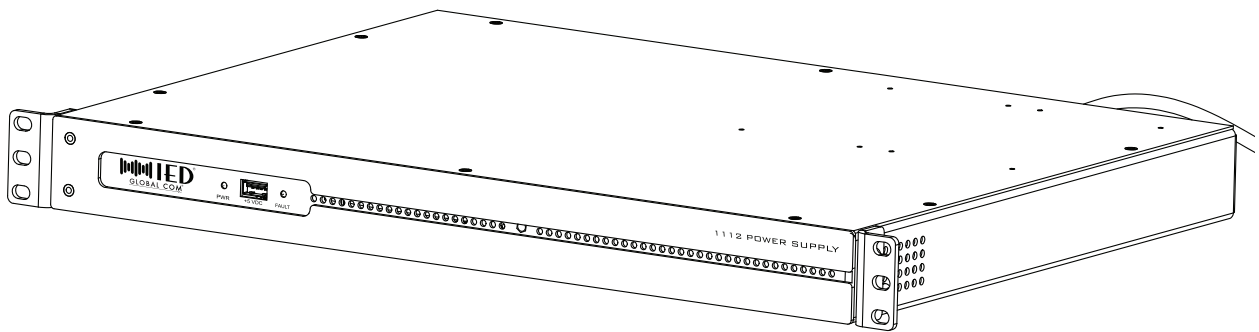

Copyright © 2013 Innovative Electronic Designs, LLC. All Rights Reserved

If this document is distributed with software that includes an end user agreement, this document, as well as the software described in it, is furnished under license and may be used or copied only in accordance with the terms of such license. Except as permitted by any such license, no part of this document may be reproduced or transmitted in any form or by any means, electronic or mechanical, including photocopying, recording, storage in an information retrieval system, or otherwise, without the prior written permission of Innovative Electronic Designs, LLC. Please note that the content in this guide is protected under copyright law even if it is not distributed with software that includes an end user license agreement.

The content of this document is furnished for informational use only and is subject to change without notice. It should not be construed as a commitment by Innovative Electronic Designs, LLC. Innovative Electronic Designs, LLC assumes no responsibility or liability for any errors or inaccuracies that may appear in the informational content contained in this document.

Any reference to company names in examples are for demonstration purposes only and are not intended to refer to any actual organization or an endorsement of any kind.

Innovative Electronic Designs, IED, 500ACS, 500ACS Announcement Control System, CAS, Courtesy Announcement System, T-CAS, FAS, Flight Announcement System, IED On Call, IED On Call & Design, and LANcom are all registered trademarks or trademarks of Innovative Electronic Designs, LLC in the United States and/or other countries.

CobraNet is a registered trade mark of Cirrus Logic in the United States and/or other countries.

Microsoft, Windows, Windows Vista, Windows 7, Windows Server, SQL Server, and Internet Explorer are all registered trademarks or trademarks of Microsoft Corporation in the United States and/or other countries.

Innovative Electronic Designs, LLC
9701 Taylorsville Road
Louisville, KY 40299
United States of America



www.iedaudio.com

Document Number: 1203B

TABLE OF CONTENTS

IMPORTANT SAFETY INSTRUCTIONS	2
SAFETY SYMBOLS.....	2
SAFETY CONSIDERATIONS	3
SAFETY PRECAUTIONS	3
GENERAL PRECAUTIONS	3
PRELIMINARY PRECAUTIONS	3
PRECAUTIONS WHEN MEASURING HIGH VOLTAGE POTENTIALS.....	4
PRECAUTIONS WHEN WORKING ON ENERGIZED EQUIPMENT.....	4
AC POWER CIRCUITS.....	4
RESUSCITATION.....	5
DESCRIPTION	5
CONNECTIONS	6
IED1112PS INSTALLATION	8
UNPACKING AND PREPARING THE UNIT	8
INSTALL UNIT INTO A RACK	8
INSTALL FUSES	9
CONNECT FAULT RELAY AND POWER OUTPUT CABLES.....	9
INSTALL PRIMARY POWER SUPPLY	10
OPTIONAL – INSTALL SECOND (BACKUP) POWER SUPPLY.....	10
CONNECT POWER PLUG.....	11
SPECIFICATIONS.....	12
FCC NOTICE.....	12

IMPORTANT SAFETY INSTRUCTIONS

<ol style="list-style-type: none"> 1. Read these instructions. 2. Keep these instructions. 3. Heed all warnings. 4. Follow all instructions. 5. Do not use this apparatus near water. 6. Clean only with dry cloth. 7. Do not block any ventilation openings. Install in accordance with the manufacturer's instructions. 8. Do not install near any heat sources such as radiators, heat registers, stoves, or other apparatus (including amplifiers) that produce heat. 9. Do not defeat the safety purpose of the polarized or grounding-type plug. A polarized plug has two blades with one wider than the other. A grounding type plug has two blades and a third grounding prong. The wide blade or the third prong is provided for your safety. If the provided plug does not fit into your outlet, consult an electrician for replacement of the obsolete outlet. 10. Protect the power cord from being walked on or pinched particularly at plugs, convenience receptacles, and the point where they exit from the apparatus. 11. Only use attachments/accessories specified by the manufacturer. 	<ol style="list-style-type: none"> 12.  Use only with the cart, stand, tripod, bracket, or table specified by the manufacturer, or sold with the apparatus. When a cart is used, use caution when moving the cart/apparatus combination to avoid injury from tip-over. 13. Unplug this apparatus during lightning storms or when unused for long periods of time. 14. Refer all servicing to qualified service personnel. Servicing is required when the apparatus has been damaged in any way, such as power-supply cord or plug is damaged, liquid has been spilled or objects have fallen into the apparatus, the apparatus has been exposed to rain or moisture, does not operate normally, or has been dropped. <div style="border: 1px solid black; padding: 5px; margin-top: 10px;"> <div style="display: flex; justify-content: space-between; align-items: center;"> <div style="text-align: center;">  </div> <div style="text-align: center;"> <p>CAUTION</p> <p>RISK OF ELECTRIC SHOCK DO NOT OPEN</p> <p>RISQUE DE CHOC ELECTRIQUE NE PAS OUVRIR</p> </div> <div style="text-align: center;">  </div> </div> <div style="text-align: center; margin-top: 5px;"> <p>CAUTION: TO REDUCE THE RISK OF ELECTRIC SHOCK DO NOT REMOVE COVER (OR BACK) NO USER SERVICEABLE PARTS INSIDE REFER SERVICING TO QUALIFIED PERSONNEL</p> </div> </div>
---	--

WARNING: To reduce the risk of fire or electric shock, do not expose this apparatus to rain, moisture, dripping, splashing, or place objects filled with liquids on the equipment.

WARNING: If apparatus is equipped with Class I grounding plugs for safety purposes, it must be connected to MAINS that employ a protective earth ground connection.

WARNING: The MAINS plug on this device may be used as the DISCONNECT DEVICE for MAINS power and must remain readily operable.

WARNING: Installation and maintenance of IED equipment is to be made by trained/qualified personnel and must conform to all applicable local codes.

WARNING: If unit contains a lithium battery, there is a danger of explosion. Replace only with the same or equivalent type.

SAFETY SYMBOLS

Labeling on products and the *Installation Instructions & User Manual* may use safety related graphical symbols as shown below to note safety requirements.



Lightning Bolt: The lightning flash with arrowhead symbol, within an equilateral triangle, WARNING symbol, is intended to alert the user to the presence of un-insulated **dangerous voltage** within the product's enclosure that may be sufficient in magnitude to constitute a risk of electric shock to persons or domestic animals.



Exclamation Point: The exclamation point within an equilateral triangle, CAUTION symbol, is intended to alert the user to the presence of important operating and maintenance (servicing) instructions, or a hazard that can damage equipment.



Do not proceed beyond a WARNING or CAUTION notice until you have understood the hazardous condition and have taken appropriate steps.

Ne continuez pas avant d'avoir pris connaissance du danger et prendre les mesures appropriées.

SAFETY CONSIDERATIONS

SAFETY PRECAUTIONS

Personnel properly qualified in the application and use of life safety equipment (“qualified personnel”) shall read this manual carefully before performing any actions to specify, apply, install, maintain and perform operational tests of IED systems, and associated products in accordance with the instructions in this manual. This manual shall be made available to all qualified personnel who operate, test, maintain, or service IED systems, and associated products. It is strongly recommend that such personnel read and understand the entire manual.

WARNING: IF SAFETY PRECAUTIONS, INSTALLATION AND TESTING ARE NOT PERFORMED PROPERLY, CONDITIONS COULD EXIST IN WHICH THE IED SYSTEM MAY NOT OPERATE, OR MAY OPERATE IMPROPERLY. THIS COULD RESULT IN PROPERTY DAMAGE AND SERIOUS INJURY OR DEATH TO YOU AND/OR OTHERS.

It is very important that only responsible, trained personnel are allowed to operate and maintain these systems, and that they use only appropriate equipment and tools. If a person is not trained, they shall contact the IED factory for direction on how to operate and maintain an IED system.

Unauthorized personnel and equipment must be restricted from the areas of operation.

All operations should be performed carefully, methodically, and without hurrying. Greater effectiveness will be developed by increased familiarity of personnel with their assignments. During any maintenance operation, if a malfunction occurs or an incorrect indication appears, stop the operation and determine whether or not it is safe to proceed. Before performing any step in a procedure, be sure that the preceding step has been properly executed and correct results obtained. Cleanliness and good housekeeping in all installation areas are major factors in effective accident prevention. Tools and equipment should be maintained in good working order and should always be returned to their proper storage place after usage. Cleaning agents and other cleaning aids should be removed from the equipment areas immediately upon completing the task at hand.

GENERAL PRECAUTIONS

Changes, modifications, or additions in connection with the IED system equipment shall not be made without explicit authorization of IED.

Safety devices found on mechanical, and electrical and electronic equipment are put there for the protection of personnel and equipment. These devices must be maintained in good working order and operative at all times. Safety devices shall never be removed or bypassed unless specifically authorized by the IED factory. Where safety devices have been rendered inoperable by proper and specific authorization, adequate notices shall be posted to warn personnel of the potential hazard.

Avoid the use of flammable or toxic cleaning fluids, and the use of carbon tetrachloride is prohibited.

Maintenance of the equipment shall be at least what is specified in the IED manuals and literature, and performed only by qualified personnel.

Whenever operation and maintenance is ongoing, personnel in the equipment areas shall have an effective communication among these areas in order to protect people if any accident occurs.

PRELIMINARY PRECAUTIONS

Precautions which are applicable to general electrical or electronic maintenance are as follows:

- a. Check yourself. Wear no article that might catch on equipment or that might act as a conductor.
- b. Check the working area. The equipment area shall be clean and dry. If possible, stand on a special insulator such as a rubber mat. There should be ample working space and good lighting.
- c. Check the tools. Always use proper tools and check them for their safe condition. Use screwdrivers with plastic handles. Check test equipment periodically and examine test leads carefully as the slightest break in insulation is dangerous.

- d. Check the procedures. Study the entire procedure before taking the first step. Consult the circuit diagram frequently to obtain an understanding of what is accomplished at each step. Know what is in the equipment and how it differs from others on which you have worked.
- e. Be aware that high voltages may be present across terminals that are normally low voltage, due to equipment breakdown. Be careful when measuring low voltages in equipment containing high voltage circuits.
- f. Do not make resistance measurements with power on.
- g. Do not work within the equipment without the presence of a person who is capable of rendering aid, and who is familiar with the procedure for emergency shutdown of the equipment.

PRECAUTIONS WHEN MEASURING HIGH VOLTAGE POTENTIALS

Observe the following precautions when measurements must be performed on circuits with potentials over 48 volts.

- a. Do not measure potentials over 48 volts without the presence or assistance of a person who is capable of rendering aid, and who is familiar with the procedure for emergency shutdown of the equipment.
- b. Be sure you are not grounded when you are adjusting equipment or using measuring equipment. Stand on a rubber mat or other insulator if possible. Be sure the equipment area is clean and dry. In general, use only one hand when servicing live equipment.
- c. If a test meter must be held or adjusted while voltage is applied, ground the case of the meter before starting a measurement. Do not touch the live equipment or personnel working on live equipment while holding the meter. The “common” terminal on some A/C electronic voltmeters is at ground potential; never connect the “common” terminal to any point above ground potential.
- d. High-voltage, high-capacitance capacitors should be discharged before servicing is started.



WARNING! Discharging must be done carefully and judiciously. First ascertain whether there is a built-in bleeder network. If so, wait a minute or two for the capacitor to discharge through the network. Otherwise, use an external discharge network. This is most important in the case of high voltage or high capacitance capacitors. If one terminal is connected to ground, connect the discharge network between the other terminal and ground. If neither terminal of the capacitor is grounded, connect the network across the capacitor terminals. Connecting a short circuit across the terminals is not recommended. Doing so can produce extremely high currents and a flash which can injure the eyes, vaporize metals, and cause burns.

PRECAUTIONS WHEN WORKING ON ENERGIZED EQUIPMENT

When it is necessary to work on energized equipment, think ahead and anticipate every hazard. Never work alone on energized equipment.

Interlock switches are installed on some of the doors and panels to break the power circuits when the enclosure is entered. When it is necessary to work within such an enclosure on energized equipment, the interlock may be bypassed. Extreme caution should then be exercised, as dangerous voltages are present within the unit.

AC POWER CIRCUITS

Equipment obtaining power from a secondary distribution system should be grounded at all times by means of a third grounding wire on the power lines. Equipment permanently wired to a secondary distribution system should also be grounded separately by connection to a grounding bus or ground rod with a sufficiently large conductor to handle the current expected if the secondary source is accidentally shorted to the equipment.

The ground wire should be protected from mechanical damage and periodically inspected for good physical condition.

Personnel should never depend on a switch to remove power from equipment. If the equipment is connected to the secondary distribution system by means of a power cable, detach the cable from the receptacle before attempting any repairs or removal of chassis.

If the equipment is permanently wired to the secondary distribution system, remove the main fuses or open the power switch. Attach a suitable warning tag to the switch which will warn personnel not to operate the equipment; only the person who originally attaches the warning tag should be authorized to remove it.

RESUSCITATION

Personnel working with or near high voltage should be familiar with modern methods of resuscitation. Such information and training is available from the Red Cross or local emergency response personnel such as the police and fire departments.

DESCRIPTION

The 1112PS is a rack mount power supply designed to provide 12V DC power to GLOBALCOM devices. The 1112PS ships with a single 1112PSM power supply module capable of delivering up to 37 Amps of 12V DC power to as many as eight (8) GLOBALCOM devices. This allows a single power supply to power multiple 1100ACS, 1200ACS, 1100MSG, 200MSG, and 1300CNB units. Each unit is connected to a fused power output port on the rear of the 1112PS. The connectors are secured using the supplied cover plate to prevent unwanted disconnections. A second 1112PSM power supply module can be added to provide redundancy. If a module fails, the remaining module will assume the full load. A module can be replaced while the other module is left on without interrupting power to the system. A relay is provided that will de-energize if a power supply module has failed. This closure can be monitored through the supervision system.

CONNECTIONS

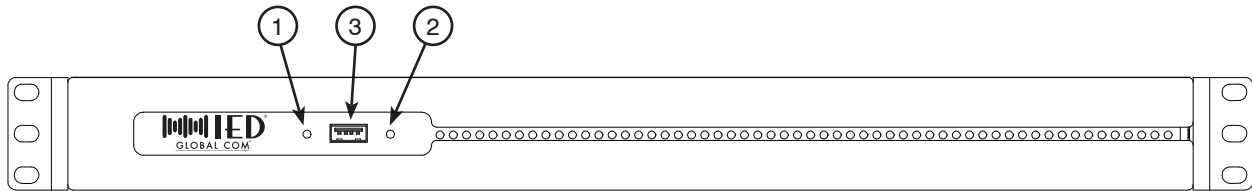

Figure 1 - IED112PS Front View

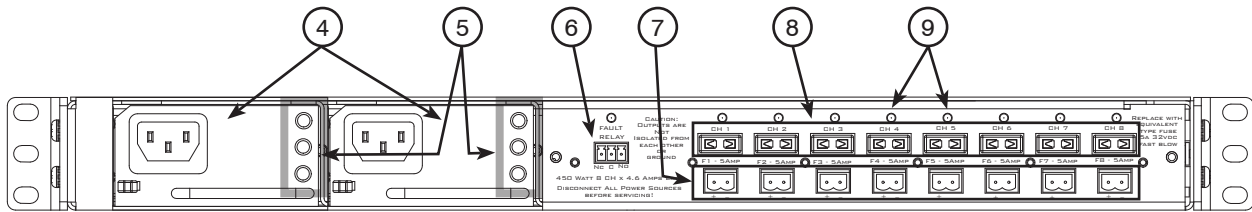

Figure 2 - IED112PS Rear View

1. Power LED

This LED will illuminate when the unit is powered on.

2. Fault LED

This LED will illuminate when a power supply fault is present or if an output fuse has failed. This corresponds with the de-energizing of the fault relay.

3. USB Power Port

5V DC power is available at this port to allow charging of portable devices with a USB connection.

4. Power Supply Modules

A single IED112PSM power supply module is included with the IED112PS and will be installed in one of the two available bays. A second IED112PSM power supply module can be added to the unit to provide redundant power. When two modules are installed, they will share the total load placed on the unit. If either module fails, the total load will be assumed by the remaining module.

5. Power Supply Status Indicators

These LED's indicate the operational status of the individual power supply module.

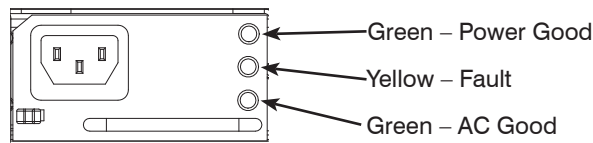

Figure 3 - IED112PSM Status Indicators

6. Fault Relay Terminal

This connector utilizes a 3-pin Phoenix plug with 3.8mm spacing to access the status of the fault relay. The relay is energized when no fault condition is present and the contact is closed between the NC and C terminals. The relay will de-energize when a power supply fault is present and the contact is closed between the NO and C terminals. The fault relay will trip if a power supply has failed or if an output fuse has failed or has been removed.



Figure 4 - Fault Relay Connector

7. Power Output Terminals (8)

There are eight (8) output ports available that use 2-pin Phoenix plugs with 5.08mm spacing. Each port can be used to power a GLOBALCOM device using the supplied adaptor cable.

8. Output Port Fuses (8)

Each output port is protected by a 5A fuse. Use a 5A 32VDC (fast blow) blade style fuse for replacement in the event that a fuse is blown.

9. Fuse Status LEDs (8)

Each output port has a green status LED located directly above the fuse. This IED illuminates green when power is available at the port. The LED will turn off when the fuse is blown or removed, indicating that power is not available at that output port.

IED1112PS INSTALLATION

⚠ WARNING! Before performing the following procedure, review the safety instructions on the previous pages.

NOTE: This equipment is intended for installation in a restricted access location.

UNPACKING AND PREPARING THE UNIT

Unpack the unit from its shipping carton and identify any accompanying components that may have been included. Attach the rack ears as shown in Figure 5 to allow the unit to be mounted in a standard 19" equipment rack. Adjust the ear positions so the front of the ear is even with the front of the unit and tighten the screws securely.

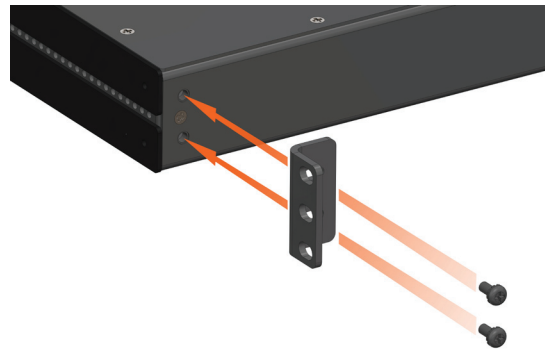

Figure 5 - Attaching Rack Mount Ears to the Unit

INSTALL UNIT INTO A RACK

The IED1112PS requires one rack unit (1 RU) of available space and a recommended mounting depth of 18" to allow adequate clearance for cabling. Select a location in the 19" rack for the unit based on proximity to the device that will be served by the unit. Mount the unit using suitable screws for the rack being used, two per rack mount ear. Please refer to any safety and installation instructions that came with the rack prior to assembly.

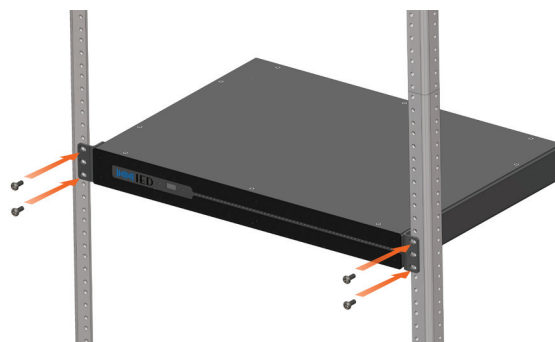

Figure 6 - Mounting Unit in a Rack

INSTALL FUSES

If the unit shipped with fuses un-installed, install them now by inserting them straight into the fuse sockets provided for each power output connection as shown in Figure 7.

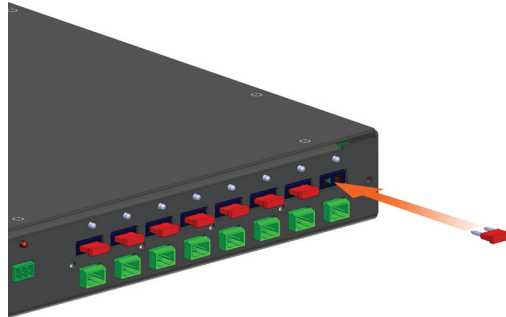

Figure 7 - Inserting Fuses

CONNECT FAULT RELAY AND POWER OUTPUT CABLES

The optional fault relay connection may be connected via the Phoenix connector in the center of the back of the unit. Also, attach power output cables for all of the required devices to be powered by the 1112PS, as shown in Figure 8.

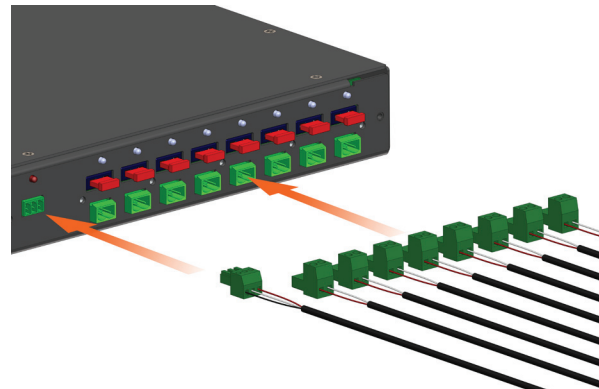
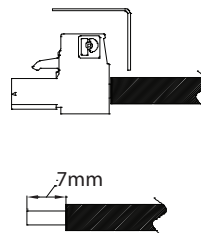

Figure 8 - Connecting Fault Relay and Output Power

To ensure the power output connections and relay connection do not get accidentally pulled out nor the fuses accidental damaged, install the provided cover plate to secure them using the provided screws as shown in Figure 9.

CAUTION! Ensure that wire is stripped no more than 7mm from the end in order to prevent the wire from shorting to the rear cover plate. Do not allow any insulation to be crimped in the compression terminal.

Correct



Incorrect

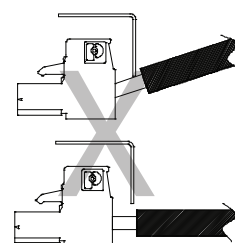

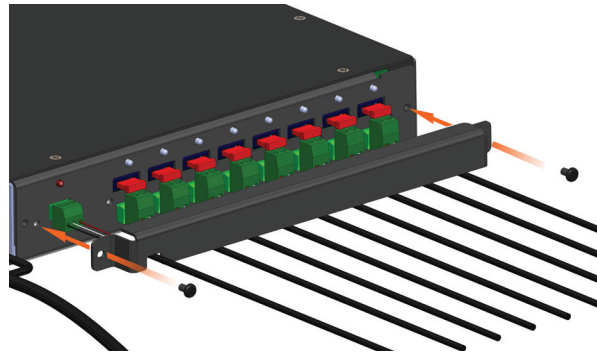

Figure 9 - Securing Cover Plate Over the Connectors

INSTALL PRIMARY POWER SUPPLY

Unpack the primary power supply module (IED1112PSM) and install it as shown in Figure 10. Press firmly until the locking tab snaps into place.

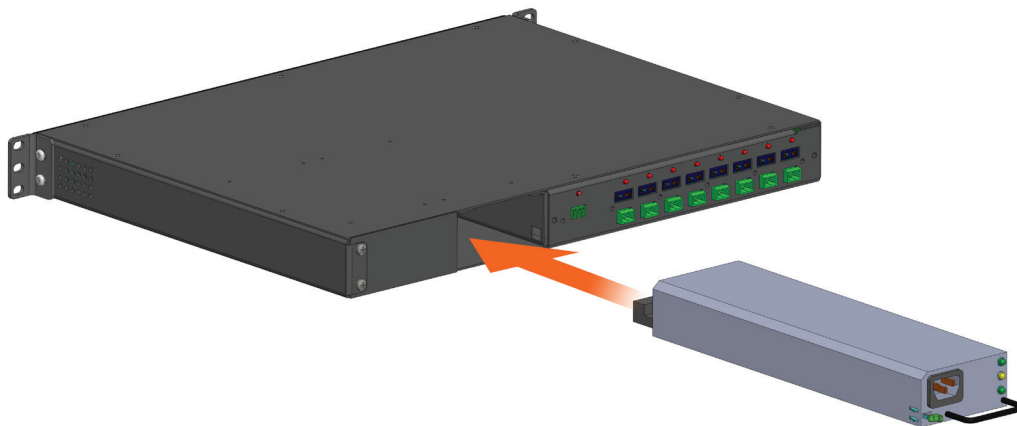

Figure 10 - Installing Primary IED1112PSM Power Supply

OPTIONAL – INSTALL SECOND (BACKUP) POWER SUPPLY

If a second power supply module (IED1112PSM) was purchased for redundancy, it will be boxed separately. Remove the blank cover plate on the rear of the unit as shown in Figure 11. Remove the module from its packaging and install in the open slot as shown in Figure 12.

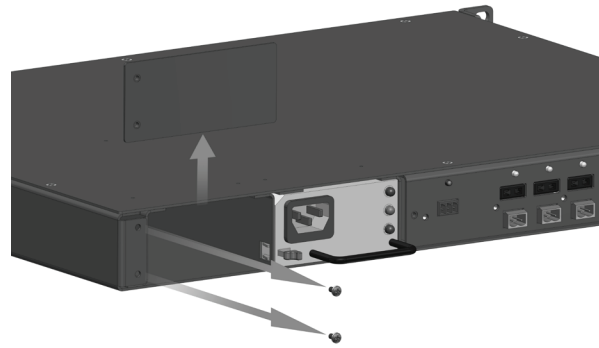

Figure 11 - Power Supply Slot Cover Removal

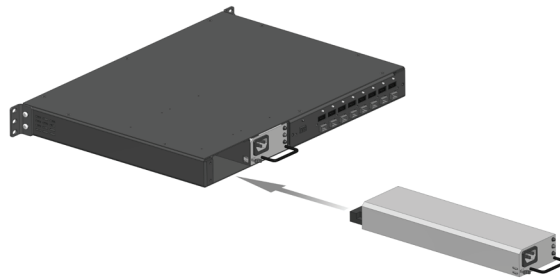

Figure 12 - Installing Second IED1112PSM Power Supply Module

CONNECT POWER PLUG

Attach the AC power cables by plugging them into the power supply modules as shown in Figure 13. (Note, if there is only one supply, only one power plug will be installed.)

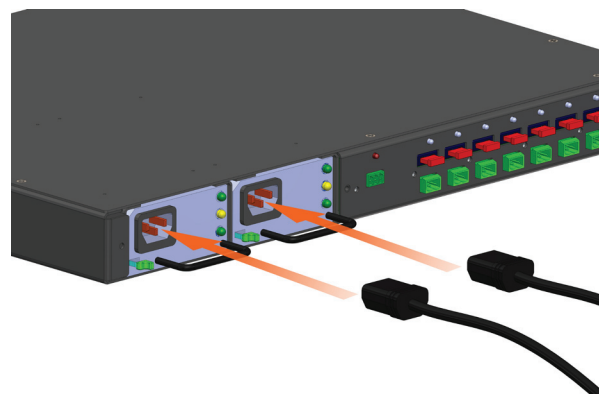

Figure 13 - Connect Power Plugs

SPECIFICATIONS

ELECTRICAL

1. Supply Voltage 120 – 240VAC (50-60Hz)
2. Rated Input Current (per supply) 8 Amps Max
3. Rated Output Voltage +12VDC ($\pm 5\%$)
4. Rated Output Current (total) 37 Amps
5. Rated Output Current (per output) 4.6 Amps
6. Relay Contact Rating Form C, 1A 30VDC, 0.3A 125VAC
7. Output Fuse (8) 5 Amp 32VDC (Fast Blow) Blade Fuse

MECHANICAL

1. Height (4.4 cm) 1.75"
2. Width (without rack mount ears) (43.2 cm) 17"
3. Depth (31.1 cm) 12.25"
4. Recommended Mounting Depth (45.7 cm) 18"
5. Weight (with 1 x IED1112PSM module) (5.9 kg) 13 lb.
6. Weight (with 2 x IED1112PSM modules) (7.1 kg) 15.6 lb.

ENVIRONMENTAL

1. Operating Temperature Range (32 °F – 104 °F) 0 °C – 50 °C
2. Storage Temperature Range (-40 °F – 158 °F) -40 °C – 70 °C

CONNECTORS

1. Input Power IEC 60320 Type C-13
2. Output Power (typical of 8) 2-pin Phoenix, 5.08 mm spacing
3. Fault Relay 3-pin Phoenix, 3.8mm spacing

COMPLIANCE

1. SAFETY:

UL60950-1 (Ed.2) Listed
CAN/CSA C22.2 No. 60950-1-07 (Ed.2) Certified
IEC 60950-1: 2005; AM 1:2009
EN 60950-1:2—6/A11:2009/A1:2010
CB Certificate

2. FCC / EMC:

CFR, Title 47, Chapter I, Part 15 Subpart B
ICES-003, Issue 4, 2004
AS/NZS CISPR 22: 2005
CISPR 22 (Ed.5): 2005 +A1 (EN 55022: 2006 +A1)
CISPR 24 (Ed.1): 1997 +A1, A2 (EN 55024:1998 +A1, +A2)
IEC 61000-3-2 (Ed.3): 2005, +A1,A2 (EN 61000-3-2:2006)
IEC 61000-3-3 (Ed.2): 2008 (EN 61000-3-3:1995 +A1, +A2)

FCC NOTICE

This device complies with part 15 of the FCC Rules. Operation is subject to the following two conditions:

1. This device may not cause harmful interference.
2. This device must accept any interference received, including interference that may cause undesired operation.

NOTE: This equipment has been tested and found to comply with the limits for a Class A digital device, pursuant to part 15 of the FCC Rules. These limits are designed to provide reasonable protection against harmful interference when the equipment is operated in a commercial environment. This equipment generates, uses, and can radiate radio frequency energy and, if not installed and used in accordance with the instruction manual, may cause harmful interference to radio communications. Operation of this equipment in a residential area is likely to cause harmful interference in which case the user will be required to correct the interference at his own expense.

Innovative Electronic Designs, LLC
9701 Taylorsville Road
Louisville, KY 40299, USA

+1.502.267.7436 phone
+1.502.267.9070 fax
www.iedaudio.com

