

Conceptum M Profile

□ 436-MX195W

■ 436-MX195



CONTENT:

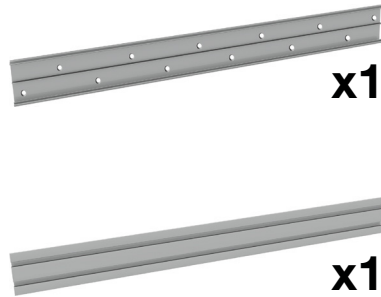

1 RECOMMENDATIONS FOR INSTALLATION

- To be installed 250 mm above table top.
- Wood screw: TFX-S FZB 5x20.
- Minimum 10 wood screws per meter.

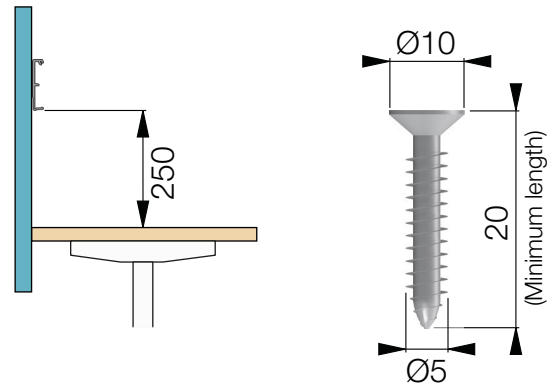

ADDITIONAL RECOMMENDATIONS (FOR RECESSED INSTALLATION ONLY)

- Absolutely necessary to fit-test with individual screen to ascertain product compatibility. Kondator can not be held responsible for the outcome.
- Example below shows screen with 1 mm thick fabric: **72 + 2x1* mm**
1950 + 2x1* mm
Be sure to compensate for screen and fabric.

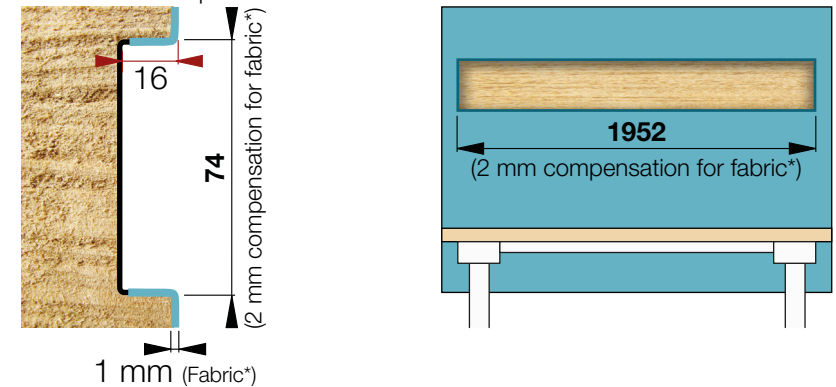

2 ATTACH PROFILE TO SCREEN

Align the screws to the center of each respective hole. Start from the center and secure the screws in the same pattern as in the illustration. Once all screws are fixed, tighten them again, in the same pattern (IMPORTANT).

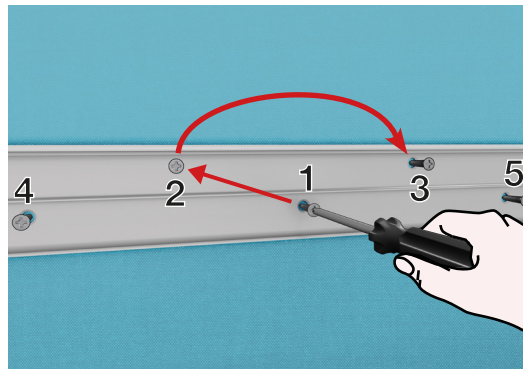

3 JOIN TOGETHER

Align the cavities on the top, and rotate all the way down in a downward direction.

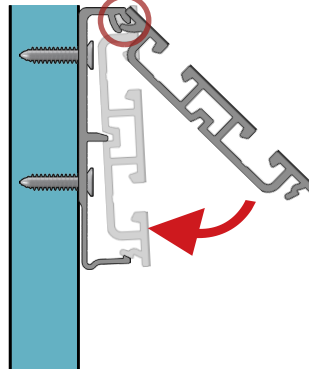

4 SECURE WITH SNAP LOCK

Handpressure or a plastic/rubber hammer should suffice to lock it into position

Note! Be sure to align the ends of both profiles horizontally as no further changes will be possible!

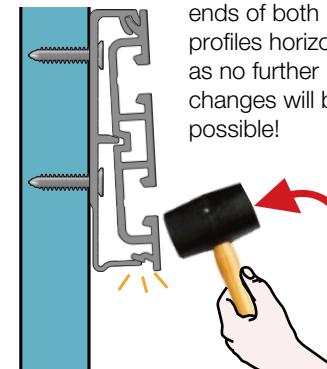

5 ACCESSORY (NOT INCLUDED)

Attach side covers to both ends.
436-MENE End cover, Grey
436-MENEW End cover, White

