



KRAMER ELECTRONICS LTD.

USER MANUAL

MODELS:

6410N

Digital to Analog Audio
Converter

6420N

Analog to Digital Audio
Converter



6410N, 6420N Quick Start Guide

This guide helps you install and use your product for the first time. For more detailed information, go to http://www.kramerelectronics.com/support/product_downloads.asp to download the latest manual or scan the QR code on the left.

Step 1: Check what's in the box

- 6410N** D/A Audio Converter and/or **6420N** A/D Audio Converter
- 4 Rubber feet
- 1 Power supply per unit (12V DC)
- 1 Quick Start sheet

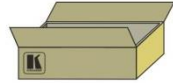

Save the original box and packaging materials in case you need to return your **6410N, 6420N** for service.

Step 2: Install the 6410N, 6420N

Attach the rubber feet and place on a table or mount the **6410N, 6420N** in a rack (using an optional **RK-1** rack adapter).

Step 3: Connect the inputs and outputs

Always switch off the power on each device before connecting it to your **6410N, 6420N**.

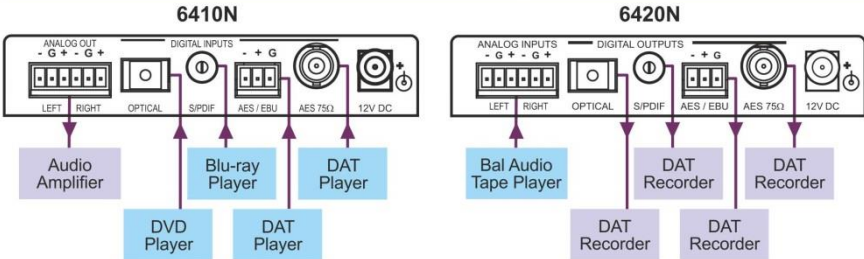

Always use Kramer high-performance cables for connecting AV equipment to the **6410N, 6420N**.

Step 4: Connect the power

Connect the 12V DC power adapter to the **6410N, 6420N** and plug the adapter into the mains electricity.



Step 5: Operate the 6410N, 6420N

Set the Gain Control DIP-switches as needed. Choose the digital audio standard format.

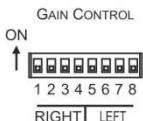

Contents

1	Introduction	1
2	Getting Started	2
2.1	Achieving the Best Performance	2
2.2	Safety Instructions	3
2.3	Recycling Kramer Products	3
3	Overview	4
3.1	Digital Audio Inputs/Outputs on the 6410N and 6420N	4
3.2	About the 6410N	4
3.3	About the 6420N	5
4	Your Audio Converters	7
4.1	Your 6410N Digital to Analog Audio Converter	7
4.2	Your 6420N Analog to Digital Audio Converter	9
5	Using the Audio Converters	11
5.1	Connecting the 6410N Digital to Analog Audio Converter	11
5.2	Connecting the 6420N Analog to Digital Audio Converter	13
6	Technical Specifications	15
6.1	6410N Specifications	15
6.2	6420N Specifications	16

Figures

Figure 1:	Professional and Consumer Inputs/Outputs on the 6410N / 6420N	4
Figure 2:	6410N Digital to Analog Audio Converter	7
Figure 3:	6410N Digital to Analog Audio Converter Underside	8
Figure 4:	6420N Analog to Digital Audio Converter	9
Figure 5:	6420N Analog to Digital Audio Converter Underside	10
Figure 6:	Connecting the 6410N Digital to Analog Audio Converter	12
Figure 7:	Connecting the 6420N Analog to Digital Audio Converter	14

1 Introduction

Welcome to Kramer Electronics! Since 1981, Kramer Electronics has been providing a world of unique, creative, and affordable solutions to the vast range of problems that confront video, audio, presentation, and broadcasting professionals on a daily basis. In recent years, we have redesigned and upgraded most of our line, making the best even better!

Our 1,000-plus different models now appear in 14 groups that are clearly defined by function: GROUP 1: Distribution Amplifiers; GROUP 2: Switchers and Routers; GROUP 3: Control Systems; GROUP 4: Format/Standards Converters; GROUP 5: Range Extenders and Repeaters; GROUP 6: Specialty AV Products; GROUP 7: Scan Converters and Scalers; GROUP 8: Cables and Connectors; GROUP 9: Room Connectivity; GROUP 10: Accessories and Rack Adapters; GROUP 11: Sierra Video Products; GROUP 12: Digital Signage; GROUP 13: Audio; and GROUP 14: Collaboration.

Congratulations on purchasing your Kramer **6410N**, **6420N**, which are ideal for the following typical applications:

- Audio broadcast and production studios
- Non-linear editing studios
- Multimedia and presentation format conversion
- Diagnostics of audio equipment during field operation

2 Getting Started

We recommend that you:

- Unpack the equipment carefully and save the original box and packaging materials for possible future shipment
- Review the contents of this user manual



Go to http://www.kramerelectronics.com/support/product_downloads.asp to check for up-to-date user manuals, application programs, and to check if firmware upgrades are available (where appropriate).

2.1 Achieving the Best Performance

To achieve the best performance:

- Use only good quality connection cables (we recommend Kramer high-performance, high-resolution cables) to avoid interference, deterioration in signal quality due to poor matching, and elevated noise levels (often associated with low quality cables)
- Do not secure the cables in tight bundles or roll the slack into tight coils
- Avoid interference from neighboring electrical appliances that may adversely influence signal quality
- Position your Kramer **6410N**, 6420N away from moisture, excessive sunlight and dust



This equipment is to be used only inside a building. It may only be connected to other equipment that is installed inside a building.

2.2 Safety Instructions



Caution: There are no operator serviceable parts inside the unit

Warning: Use only the Kramer Electronics input power wall adapter that is provided with the unit

Warning: Disconnect the power and unplug the unit from the wall before installing

2.3 Recycling Kramer Products

The Waste Electrical and Electronic Equipment (WEEE) Directive 2002/96/EC aims to reduce the amount of WEEE sent for disposal to landfill or incineration by requiring it to be collected and recycled. To comply with the WEEE Directive, Kramer Electronics has made arrangements with the European Advanced Recycling Network (EARN) and will cover any costs of treatment, recycling and recovery of waste Kramer Electronics branded equipment on arrival at the EARN facility. For details of Kramer's recycling arrangements in your particular country go to our recycling pages at <http://www.kramerelectronics.com/support/recycling/>.

3 Overview

Both the **6410N** *Digital to Analog Audio Converter* and the **6420N** *Analog to Digital Audio Converter* use digital audio transmission standards, as [Section 3.1](#) describes.

This section summarizes the:

- Digital and audio outputs on the **6410N** and **6420N** (see [Section 3.1](#))
- **6410N** (see [Section 3.2](#))
- **6420N** (see [Section 3.3](#))

3.1 Digital Audio Inputs/Outputs on the 6410N and 6420N

[Figure 1](#) illustrates the transmission standards for professional and consumer formats, which can be translated via the **6410N/6420N**.

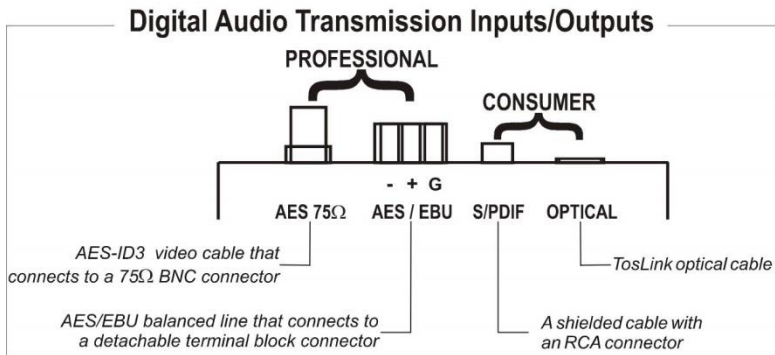

Figure 1: Professional and Consumer Inputs/Outputs on the 6410N / 6420N

3.2 About the 6410N

The **6410N** is a high performance format converter for digital audio signals. It converts AES/EBU, AES-ID3, S/PDIF or Toslink® optical digital audio signals simultaneously to:

As [Figure 6](#) illustrates, the sound is output from both the amplifier and the headphones simultaneously.

- Analog balanced stereo on detachable terminal block connectors
- Unbalanced stereo on a 3.5" jack, capable of driving a 32Ω load (headphones)

In particular, the **6410N**:

- Supports multi-standards - AES/EBU, IEC 958, S/PDIF and EIAJ CP340/1201 professional and consumer formats with sampling frequencies up to 96kHz
- Provides automatic equalization and reclocking of the digital audio stream coming from any digital input
- Automatically detects the sample rate of the digital input, ranging from 32kHz to 96kHz
- Features selectable conversion ratio (D/A) settings: 0dBFS to +12dB, +16dB, +20dB or +24dB
- Has an S/N Ratio of over 88dB
- Has AES/EBU and AES-ID3 transformer coupled inputs

The **6410N** is 12VDC fed and is housed in a DigiTOOLS enclosure.

3.3 About the 6420N

The **6420N** is a high performance format converter for balanced audio signals. It converts two channels of balanced audio signals to AES/EBU, AES-ID3, S/PDIF and Toslink® optical digital outputs simultaneously.

In particular, the **6420N**:

- Supports multi-standards - AES/EBU, IEC 958, S/PDIF and EIAJ CP340/1201 professional and consumer formats with sampling frequencies up to 96kHz
- With its analog balanced stereo audio input signal, splits to four digital audio output signals (functioning as a 1:4 DA), available in all the possible digital audio interfaces
- Features selectable sampling frequencies of 32k, 44.1k, 48k, or 96k

- Features selectable gain ratio (A/D) settings: -12dB, -16dB, -20dB or -24dB to 0dBFs
- Features selectable digital audio system bits (professional or consumer)
- Has AES/EBU and AES-ID3 transformer coupled outputs

The **6420N** is 12VDC fed and is housed in a DigiTOOLS enclosure.

4 Your Audio Converters

[Section 4.1](#) defines the **6410N** *Digital to Analog Audio Converter* and

[Section 4.2](#) defines the **6420N** *Analog to Digital Audio Converter*.

4.1 Your 6410N Digital to Analog Audio Converter

[Figure 2](#) defines the **6410N** *Digital to Analog Audio Converter*:

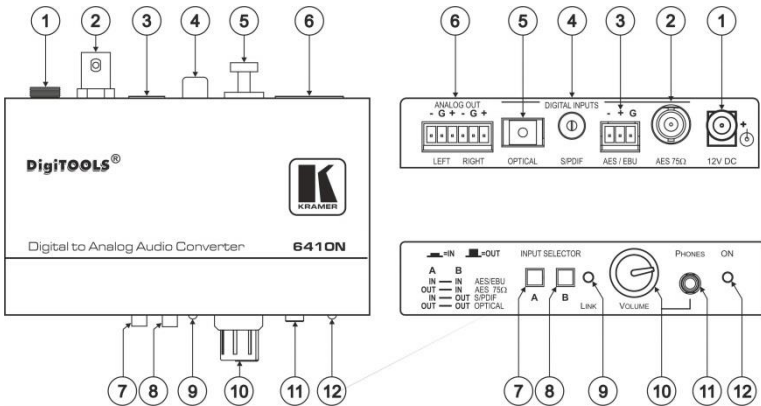

Figure 2: 6410N Digital to Analog Audio Converter

#	Feature	Function
1	12V DC	+12V DC connector for powering the unit
2	DIGITAL INPUTS	AES 75Ω BNC Connector
3		AES / EBU Detachable Terminal Block Connector
4		S/PDIF RCA Connector
5		OPTICAL Toslink® Optical Connector
6	ANALOG OUT	LEFT and RIGHT Detachable Terminal Block Connectors
7	INPUT SELECTOR	A Push Button
8		B Push Button
9	LINK LED	Illuminates when receiving the appropriate input signal
10	VOLUME Control Knob	Rotate to adjust the headphones output signal level
11	PHONES Out Connector	Connects to a headphone set
12	ON LED	Illuminates when receiving power

4.1.1 Selecting the Input

To select the input on the **6410N** use the following:

Press A	and Press B	to select:
IN	IN	AES/EBU
OUT	IN	AES 75Ω
IN	OUT	S/PDIF
OUT	OUT	OPTICAL

4.1.2 Setting the 6410N Gain Control

Set the gain control using the DIP-switches on the underside of the **6410N** as shown in [Figure 3](#).

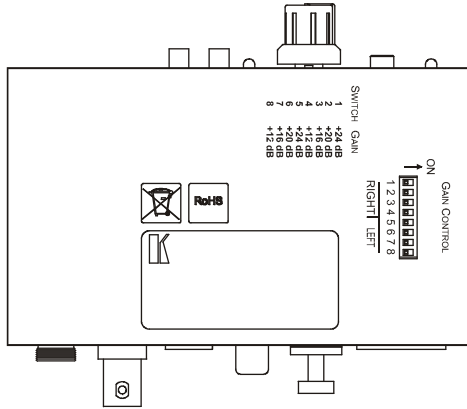

Figure 3: 6410N Digital to Analog Audio Converter Underside

Feature		Function				
GAIN CONTROL DIP-switches	RIGHT	Set the DIP-switches as follows to determine the RIGHT channel conversion ratio (D to A) (GAIN CONTROL):				
		Gain Control:	DIP 1	DIP 2	DIP 3	DIP 4
		+24dB	ON	OFF	OFF	OFF
		+20dB	OFF	ON	OFF	OFF
		+16dB	OFF	OFF	ON	OFF
	+12dB	OFF	OFF	OFF	ON	
	LEFT	Set the DIP-switches as follows to determine the LEFT channel conversion ratio (GAIN CONTROL):				
		Gain Control:	DIP 5	DIP 6	DIP 7	DIP 8
		+24dB	ON	OFF	OFF	OFF
		+20dB	OFF	ON	OFF	OFF
+16dB		OFF	OFF	ON	OFF	
+12dB	OFF	OFF	OFF	ON		

The following table shows an example of the relation between the input signal, the selected gain and the THD + N.

Vinput [vrms]	Gain [dB]	THD + N [dB] @1kHz
1	+12	-94
1	+16	-95
1	+20	-94
0.7	+24	-90

4.2 Your 6420N Analog to Digital Audio Converter

[Figure 4](#) defines the **6420N Analog to Digital Audio Converter**.

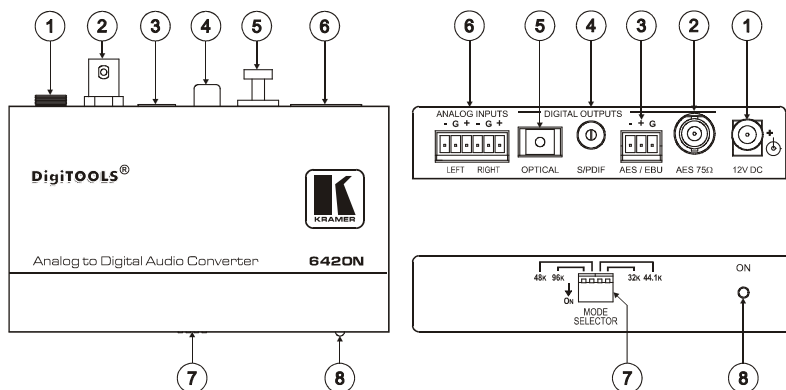

Figure 4: 6420N Analog to Digital Audio Converter

#	Feature		Function
1	12V DC		+12V DC connector for powering the unit
2	DIGITAL OUTPUTS	AES 75Ω BNC connector	Connect to the digital audio acceptor
		AES / EBU Detachable Terminal Block Connector	Connect to the digital audio acceptor
		S/PDIF RCA Connector	Connect to the digital audio acceptor
		OPTICAL Toslink® Optical Connector	Connect to the digital audio acceptor
6	ANALOG INPUTS	LEFT and RIGHT Detachable Terminal Block Connectors	Connect to the analog audio source
7	MODE SELECTOR Dipswitches		Set a dipswitch to ON to choose the appropriate sample rate frequency
8	ON LED		Illuminates when receiving power

4.2.1 The 6420N Underside

Figure 5 defines the underside of the 6420N:

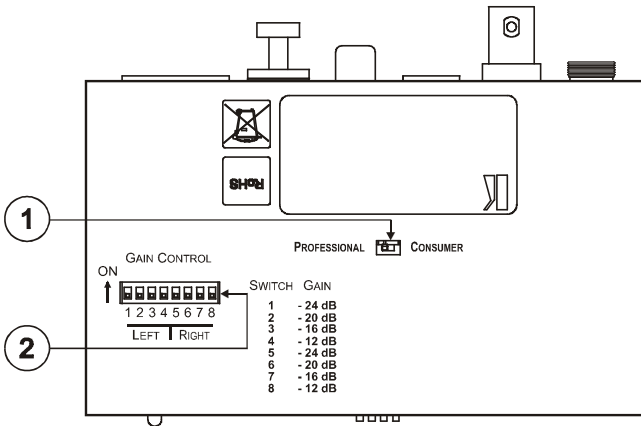

Figure 5: 6420N Analog to Digital Audio Converter Underside

#	Feature	Function				
1	<i>PROFESSIONAL / CONSUMER</i> Switch	Set to choose the digital audio system bit				
2	<i>GAIN CONTROL</i> DIP-switches	<i>LEFT</i>	Set the DIP-switches as follows to determine the LEFT channel conversion ratio (A to D) (<i>GAIN CONTROL</i>):			
		Gain Control:	DIP 1	DIP 2	DIP 3	DIP 4
		-24dB	ON	OFF	OFF	OFF
		-20dB	OFF	ON	OFF	OFF
		-16dB	OFF	OFF	ON	OFF
		-12dB	OFF	OFF	OFF	ON
		<i>RIGHT</i>	Set the DIP-switches as follows to determine the RIGHT channel conversion ratio (A to D) (<i>GAIN CONTROL</i>):			
		Gain Control:	DIP 5	DIP 6	DIP 7	DIP 8
		-24dB	ON	OFF	OFF	OFF
		-20dB	OFF	ON	OFF	OFF
-16dB	OFF	OFF	ON	OFF		
-12dB	OFF	OFF	OFF	ON		

5 Using the Audio Converters



Always switch off the power to each device before connecting it to your **6410N**, **6420N**. After connecting your **6410N**, **6420N**, connect its power and then switch on the power to each device.

[Sections 5.1](#) and [5.2](#) describe how to connect the **6410N** *Digital to Analog Audio Converter* and the **6420N** *Analog to Digital Audio Converter*, respectively.

5.1 Connecting the 6410N Digital to Analog Audio Converter

To connect your **6410N** *Digital to Analog Audio Converter*, as illustrated in the example in [Figure 6](#), do the following:

1. Connect up to four sources to the four digital input connectors, as follows:
 - Connect an AES-75Ω source (for example, a DAT-Player) to the AES-75Ω BNC input connector
 - Connect an AES/EBU source (for example, a DAT-Player) to the AES/EBU detachable terminal block input connector using a shielded twisted pair cable
 - Connect an S/PDIF source (for example, a DVD Player) to the S/PDIF RCA input connector
 - Connect an optical source (for example, a CD Player) to the optical input connector
2. Connect up to two analog acceptors, as follows:
 - Connect the ANALOG OUT LEFT and RIGHT detachable terminal block connectors via shielded twisted pair cables to an analog balanced stereo acceptor (for example, an amplifier with a pair of loudspeakers)
 - If required, connect the PHONES 3.5mm output jack to a headphone set

The headphone output is usually used for diagnostics and setup of the audio system. It is recommended to disconnect the headphones (or to minimize the headphone volume level) when not in use.

3. Connect the 12V DC power adapter to the power socket and connect the adapter to the mains electricity (not shown in [Figure 6](#)).
4. Set the conversion ratio on the underside of the unit.
It is essential that you choose the correct conversion ratio to prevent clipping, and to maintain the S/N ratio within the spec limits. The selection of the conversion rate greatly depends on the type of audio played, and also on the audio equipment that is connected to the **6410N**.

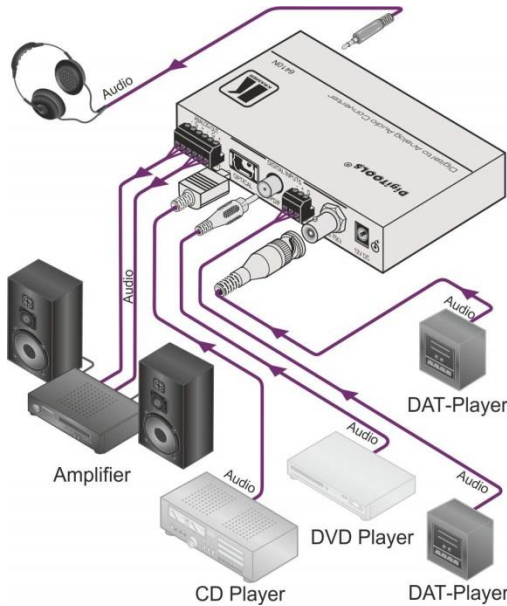

Figure 6: Connecting the 6410N Digital to Analog Audio Converter

5.1.1 Using the INPUT SELECTOR Switches

Set the digital input standard by pushing in and/or releasing one or both of the two INPUT SELECTOR switches (item 7 (button A) and item 8 (button B), in [Figure 2](#)) on the **6410N** *Digital to Analog Audio Converter*.

5.2 Connecting the 6420N Analog to Digital Audio Converter

To connect your **6420N Analog to Digital Audio Converter**, as illustrated in the example in [Figure 7](#), do the following:

1. Connect an analog balanced stereo source (for example, a balanced audio tape player) to the ANALOG INPUT LEFT and RIGHT detachable terminal block connector connectors via shielded twisted pair cables.
2. Connect the four different digital output connectors to up to four acceptors, as follows:
 - Connect the AES-75 Ω BNC output connector to an AES-75 Ω acceptor (for example, a DAT-Recorder)
 - Using a 110 Ω shielded twisted pair cable, connect the AES/EBU detachable terminal block output connector to an AES/EBU acceptor (for example, a DAT-Recorder)
 - Connect the S/PDIF RCA output connector to an S/PDIF acceptor (for example, a DAT-Recorder)
 - Connect the OPTICAL output connector to an optical acceptor (for example, a DAT-Recorder)
3. Connect the 12V DC power adapter to the power socket and connect the adapter to the mains electricity (not shown in [Figure 7](#)).
4. Set the MODE SELECTOR dipswitches on the **6420N Analog to Digital Audio Converter** to determine the appropriate digital sampling frequency.
5. On the machine underside:
 - If required, set the switch to PROFESSIONAL or CONSUMER to determine the digital audio standard format
 - Set the conversion ratio on the underside of the unit

It is essential that you choose the correct conversion rate to prevent clipping and to maintain the S/N ratio within the spec limits. The selection of the conversion rate greatly depends on the type of audio played, and also on the audio equipment that is connected to the **6420N**.

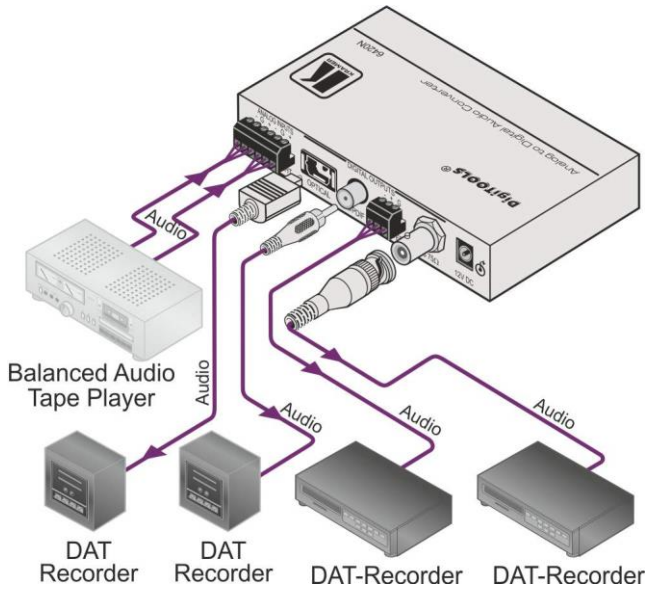

Figure 7: Connecting the 6420N Analog to Digital Audio Converter

6 Technical Specifications

6.1 6410N Specifications

INPUTS:	4 digital audio inputs: AES 75Ω; AES/EBU; S/PDIF; TosLink Optical
OUTPUTS:	2 analog outputs: balanced line out on detachable terminal blocks; 3.5mm headphone jack
SAMPLE RATE CONVERSION:	32kHz, 44.1kHz, 48kHz, 96kHz
CONVERSION GAIN:	+12dB, +16dB, +20dB, +24dB
BANDWIDTH (+4dBu/-3dBu):	20Hz to 22kHz
MAX. OUTPUT LEVEL:	11.2Vpp @1kHz
S/N RATIO:	88dB
AUDIO THD + NOISE:	-92dB
AUDIO 2nd HARMONIC:	0.003%
CONTROLS:	Input selector buttons, 8 gain switches, headphones level rotary control knob, 2 LEDs: ON and LINK
POWER CONSUMPTION:	12V DC/1.25A, 150mA
OPERATING TEMPERATURE:	0° to +40°C (32° to 104°F)
STORAGE TEMPERATURE:	-40° to +70°C (-40° to 158°F)
HUMIDITY:	10% to 90%, RHL non-condensing
DIMENSIONS:	12cm x 6.95cm x 2.44cm (4.72" x 2.74" x 0.96", W, D, H)
WEIGHT:	0.3kg (0.66lbs.) approx.
INCLUDED ACCESSORIES:	Power supply, mounting bracket
OPTIONAL:	19" rack adapters
Specifications are subject to change without notice at http://www.kramerelectronics.com	

6.2 6420N Specifications

INPUTS:	1 analog input balanced line in (10k) on detachable terminal blocks
OUTPUTS:	4 digital audio outputs: AES 75Ω; AES/EBU; S/PDIF; TosLink Optical
SAMPLE RATE CONVERSION:	32kHz, 44.1kHz, 48kHz, 96kHz
MAX. INPUT GAIN:	-12dB: 3.1Vrms; -24dB: 11.5Vrms
CONVERSION GAIN:	-12dB, -16dB, -20dB, -24dB
THD+N	Better than -92dB
IDLE CHANNEL NOISE:	Better than 99dBFS CCIR-RMS
SIGNAL-TO NOISE RATIO:	Better than 98dBFS CCIR-RMS
CONTROLS:	4 sample rate selector switches, system bit selector switch, 8 gain switches, ON LED
COUPLING:	AC
POWER CONSUMPTION:	12V DC/1.25A, 150mA
OPERATING TEMPERATURE:	0° to +40°C (32° to 104°F)
STORAGE TEMPERATURE:	-40° to +70°C (-40° to 158°F)
HUMIDITY:	10% to 90%, RHL non-condensing
DIMENSIONS:	12cm x 6.95cm x 2.44cm (4.72" x 2.74" x 0.96", W, D, H)
WEIGHT:	0.3kg (0.66lbs.) approx.
INCLUDED ACCESSORIES:	Power supply, mounting bracket
OPTIONAL:	19" rack adapters
Specifications are subject to change without notice at http://www.kramerelectronics.com	

LIMITED WARRANTY

The warranty obligations of Kramer Electronics for this product are limited to the terms set forth below:

What is Covered

This limited warranty covers defects in materials and workmanship in this product.

What is Not Covered

This limited warranty does not cover any damage, deterioration or malfunction resulting from any alteration, modification, improper or unreasonable use or maintenance, misuse, abuse, accident, neglect, exposure to excess moisture, fire, improper packing and shipping (such claims must be presented to the carrier), lightning, power surges, or other acts of nature. This limited warranty does not cover any damage, deterioration or malfunction resulting from the installation or removal of this product from any installation, any unauthorized tampering with this product, any repairs attempted by anyone unauthorized by Kramer Electronics to make such repairs, or any other cause which does not relate directly to a defect in materials and/or workmanship of this product. This limited warranty does not cover cartons, equipment enclosures, cables or accessories used in conjunction with this product.

Without limiting any other exclusion herein, Kramer Electronics does not warrant that the product covered hereby, including, without limitation, the technology and/or integrated circuit(s) included in the product, will not become obsolete or that such items are or will remain compatible with any other product or technology with which the product may be used.

How Long Does this Coverage Last

Seven years as of this printing; please check our Web site for the most current and accurate warranty information.

Who is Covered

Only the original purchaser of this product is covered under this limited warranty. This limited warranty is not transferable to subsequent purchasers or owners of this product.

What Kramer Electronics will do

Kramer Electronics will, at its sole option, provide one of the following three remedies to whatever extent it shall deem necessary to satisfy a proper claim under this limited warranty:

1. Elect to repair or facilitate the repair of any defective parts within a reasonable period of time, free of any charge for the necessary parts and labor to complete the repair and restore this product to its proper operating condition. Kramer Electronics will also pay the shipping costs necessary to return this product once the repair is complete.
2. Replace this product with a direct replacement or with a similar product deemed by Kramer Electronics to perform substantially the same function as the original product.
3. Issue a refund of the original purchase price less depreciation to be determined based on the age of the product at the time remedy is sought under this limited warranty.

What Kramer Electronics will not do Under This Limited Warranty

If this product is returned to Kramer Electronics or the authorized dealer from which it was purchased or any other party authorized to repair Kramer Electronics products, this product must be insured during shipment, with the insurance and shipping charges prepaid by you. If this product is returned uninsured, you assume all risks of loss or damage during shipment. Kramer Electronics will not be responsible for any costs related to the removal or re-installation of this product from or into any installation. Kramer Electronics will not be responsible for any costs related to any setting up this product, any adjustment of user controls or any programming required for a specific installation of this product.

How to Obtain a Remedy under this Limited Warranty

To obtain a remedy under this limited warranty, you must contact either the authorized Kramer Electronics reseller from whom you purchased this product or the Kramer Electronics office nearest you. For a list of authorized Kramer Electronics resellers and/or Kramer Electronics authorized service providers, please visit our web site at www.kramerelectronics.com or contact the Kramer Electronics office nearest you.

In order to pursue any remedy under this limited warranty, you must possess an original, dated receipt as proof of purchase from an authorized Kramer Electronics reseller. If this product is returned under this limited warranty, a return authorization number, obtained from Kramer Electronics, will be required. You may also be directed to an authorized reseller or a person authorized by Kramer Electronics to repair the product.

If it is decided that this product should be returned directly to Kramer Electronics, this product should be properly packed, preferably in the original carton, for shipping. Cartons not bearing a return authorization number will be refused.

Limitation on Liability

THE MAXIMUM LIABILITY OF KRAMER ELECTRONICS UNDER THIS LIMITED WARRANTY SHALL NOT EXCEED THE ACTUAL PURCHASE PRICE PAID FOR THE PRODUCT. TO THE MAXIMUM EXTENT PERMITTED BY LAW, KRAMER ELECTRONICS IS NOT RESPONSIBLE FOR DIRECT, SPECIAL, INCIDENTAL OR CONSEQUENTIAL DAMAGES RESULTING FROM ANY BREACH OF WARRANTY OR CONDITION, OR UNDER ANY OTHER LEGAL THEORY. Some countries, districts or states do not allow the exclusion or limitation of relief, special, incidental, consequential or indirect damages, or the limitation of liability to specified amounts, so the above limitations or exclusions may not apply to you.

Exclusive Remedy

TO THE MAXIMUM EXTENT PERMITTED BY LAW, THIS LIMITED WARRANTY AND THE REMEDIES SET FORTH ABOVE ARE EXCLUSIVE AND IN LIEU OF ALL OTHER WARRANTIES, REMEDIES AND CONDITIONS, WHETHER ORAL OR WRITTEN, EXPRESS OR IMPLIED. TO THE MAXIMUM EXTENT PERMITTED BY LAW, KRAMER ELECTRONICS SPECIFICALLY DISCLAIMS ANY AND ALL IMPLIED WARRANTIES, INCLUDING, WITHOUT LIMITATION, WARRANTIES OF MERCHANTABILITY AND FITNESS FOR A PARTICULAR PURPOSE. IF KRAMER ELECTRONICS CANNOT LAWFULLY DISCLAIM OR EXCLUDE IMPLIED WARRANTIES UNDER APPLICABLE LAW, THEN ALL IMPLIED WARRANTIES COVERING THIS PRODUCT, INCLUDING WARRANTIES OF MERCHANTABILITY AND FITNESS FOR A PARTICULAR PURPOSE, SHALL APPLY TO THIS PRODUCT AS PROVIDED UNDER APPLICABLE LAW.

IF ANY PRODUCT TO WHICH THIS LIMITED WARRANTY APPLIES IS A "CONSUMER PRODUCT" UNDER THE MAGNUSON-MOSS WARRANTY ACT (15 U.S.C.A. §2301, ET SEQ.) OR OTHER APPLICABLE LAW, THE FOREGOING DISCLAIMER OF IMPLIED WARRANTIES SHALL NOT APPLY TO YOU, AND ALL IMPLIED WARRANTIES ON THIS PRODUCT, INCLUDING WARRANTIES OF MERCHANTABILITY AND FITNESS FOR THE PARTICULAR PURPOSE, SHALL APPLY AS PROVIDED UNDER APPLICABLE LAW.

Other Conditions

This limited warranty gives you specific legal rights, and you may have other rights which vary from country to country or state to state.

This limited warranty is void if (i) the label bearing the serial number of this product has been removed or defaced, (ii) the product is not distributed by Kramer Electronics or (iii) this product is not purchased from an authorized Kramer Electronics reseller. If you are unsure whether a reseller is an authorized Kramer Electronics reseller, please visit our Web site at www.kramerelectronics.com or contact a Kramer Electronics office from the list at the end of this document.

Your rights under this limited warranty are not diminished if you do not complete and return the product registration form or complete and submit the online product registration form. Kramer Electronics thanks you for purchasing a Kramer Electronics product. We hope it will give you years of satisfaction.



For the latest information on our products and a list of Kramer distributors, visit our Web site where updates to this user manual may be found.

We welcome your questions, comments, and feedback.

Web site: www.kramerelectronics.com

E-mail: info@kramerel.com



SAFETY WARNING

Disconnect the unit from the power supply before opening and servicing



P/N: 2900-000317



Rev: 4