



CDPS-P311

4K UHD+ HDMI Video Streamer



Operation Manual

DISCLAIMERS

The information in this manual has been carefully checked and is believed to be accurate. Cypress Technology assumes no responsibility for any infringements of patents or other rights of third parties which may result from its use.

Cypress Technology assumes no responsibility for any inaccuracies that may be contained in this document. Cypress also makes no commitment to update or to keep current the information contained in this document.

Cypress Technology reserves the right to make improvements to this document and/or product at any time and without notice.

COPYRIGHT NOTICE

No part of this document may be reproduced, transmitted, transcribed, stored in a retrieval system, or any of its part translated into any language or computer file, in any form or by any means—electronic, mechanical, magnetic, optical, chemical, manual, or otherwise—without express written permission and consent from Cypress Technology.

© Copyright 2018 by Cypress Technology.

All Rights Reserved.

TRADEMARK ACKNOWLEDGMENTS

All products or service names mentioned in this document are trademarks of the companies with which they are associated.





SAFETY PRECAUTIONS

Please read all instructions before attempting to unpack, install or operate this equipment and before connecting the power supply. Please keep the following in mind as you unpack and install this equipment:

- Always follow basic safety precautions to reduce the risk of fire, electrical shock and injury to persons.
- To prevent fire or shock hazard, do not expose the unit to rain, moisture or install this product near water.
- Never spill liquid of any kind on or into this product.
- Never push an object of any kind into this product through any openings or empty slots in the unit, as you may damage parts inside the unit.
- Do not attach the power supply cabling to building surfaces.
- Use only the supplied power supply unit (PSU). Do not use the PSU if it is damaged.
- Do not allow anything to rest on the power cabling or allow any weight to be placed upon it or any person walk on it.
- To protect the unit from overheating, do not block any vents or openings in the unit housing that provide ventilation and allow for sufficient space for air to circulate around the unit.
- Please completely disconnect the power when the unit is not in use to avoid wasting electricity.

VERSION HISTORY

REVISION	DATE	SUMMARY OF CHANGE
VS1	17/08/18	Final technical review



CONTENTS

1. Introduction	1
2. Applications	1
3. Package Contents	1
4. System Requirements	2
5. Features	2
6. Operation Controls and Functions	4
6.1 Front Panel.....	4
6.2 Rear Panel.....	5
6.3 Remote Control.....	6
6.4 WebGUI Control.....	7
6.4.1 Live Tab	9
6.4.2 Streaming Tab	10
6.4.3 Audio Mixer Tab	12
6.4.4 Video Switch Tab	13
6.4.5 EDID Setting Tab.....	15
6.4.6 User Configuration Tab.....	17
6.4.7 System Setting Tab.....	17
6.4.8 Logout Tab.....	18
6.5 RS-232 Control	19
6.6 Telnet Control	19
6.7 RS-232 and Telnet Commands	20
7. Connection Diagram	33
8. Specifications	34
8.1 Technical Specifications	34
8.2 Video Specifications	35
8.3 Audio Specifications	36
8.4 Cable Specifications	36
9. Acronyms	37





1. INTRODUCTION

This unit makes online broadcasting of live video an easy and simple process. Video sources from cameras, PCs, video game consoles, etc. are a breeze to connect for immediate broadcast. Video content up to 4K UHD+ is supported and is automatically scaled to a resolution that is more appropriate for efficient streaming. In addition to the standard HDMI input, a VGA input with an analog stereo audio input is also available as a source. An HDMI output is provided for local monitoring of the selected input source.

All video content is encoded and streamed with minimal latency and high quality making it ideal for live streaming events to a variety of popular online streaming services or within the local network. An audio mixer function is included, allowing an external audio source to be mixed with the embedded audio of your HDMI source (LPCM 2.0 only) for your video stream.

Comprehensive EDID management provides improved compatibility with different sink devices. The intuitive WebGUI provides easy control of your live event stream including source selection, resolution, bitrate and more. Audio functions include volume level adjustment, mute, and mixer source selection. This unit can be controlled and configured via an intuitive WebGUI or via standard Telnet or RS-232 connections.

2. APPLICATIONS

- Webcasting
- Social Media Broadcasting
- Live Event Streaming
- Video on Demand Streaming

3. PACKAGE CONTENTS

- 1×HDMI Video Streamer
- 1×5V/3A DC Power Adapter
- 1×Remote Control (CR-181)
- 1×Shockproof Feet (Set of 4)
- 1×Operation Manual

4. SYSTEM REQUIREMENTS

- HDMI or VGA source equipment such as a media player, video game console, PC, or video camera.
- HDMI receiving equipment such as an HDTV, monitor or audio amplifier.
- The use of "Premium High Speed HDMI" cables is highly recommended.
- Video streaming preview support within the WebGUI requires the use of the Chrome, Internet Explorer or Safari browser with the appropriate plugins (VLC for IE and Safari or VXG Player for Chrome) installed.

Note: The Firefox browser does not currently support the WebGUI's video streaming preview window.

- To view RTSP streams directly on the local network, RTSP stream compatible video player software (such as VLC Media Player or PotPlayer) must be used.

5. FEATURES

- 1 HDMI and 1 VGA input
- 1 HDMI output
- HDCP 1.x and HDCP 2.2 compliant

Note: HDCP encrypted sources can not be streamed over the Internet and will be blacked out

- HDMI input/output supports resolutions up to 4K UHD (18Gbps, 4K@60Hz 4:4:4, 8-bit)
- VGA input supports resolutions up to WUXGA (1920×1200@60Hz)
- Advanced H.264 video streaming is provided at QVGA (320×240), VGA (640×480), 720p, or 1080p at up to 60fps
- Audio embedding and mixing support with the analog stereo audio input

Note: Analog audio can only be mixed with LPCM 2.0 audio from the HDMI source.

- Integrated support for live streaming to Facebook or YouTube channels



- Can act as a streaming server (using RTP/RTSP protocols) or streaming client (using the RTMP protocol)
- On screen countdown timer to inform the audience and event host of the scheduled ending time for the current stream
- Supports text overlays over live broadcasts
- Integrated downscaling function will convert UHD video content (up to 4K@60Hz) down to 1080p or lower for live video broadcast
- Generates 4 simultaneous streams from the same video source (1080p@60fps, 1080p@30fps, VGA@30fps, QVGA@30fps) for easy system integration at multiple bandwidth targets
- Supports automatic input switching
- Advanced EDID management including Internal , External & User configured EDID selections
- Control via front panel buttons, WebGUI, Telnet, RS-232, and IR remote

6. OPERATION CONTROLS AND FUNCTIONS

6.1 Front Panel

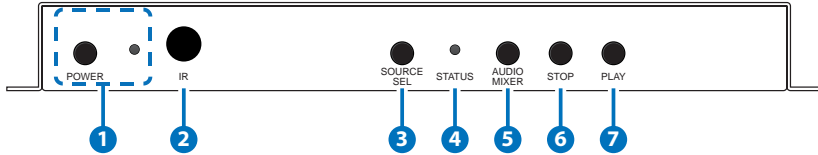

- 1 POWER BUTTON & LED:** Press this button to power the unit on or place it into stand- by mode.
- 2 IR WINDOW:** Accepts IR signals from the included IR remote for control of this unit only.
- 3 SOURCE SEL BUTTON:** Press this button to toggle between the HDMI and VGA inputs. The status LED will change depending on the input selection.
Note: Changing the input source will cause the video stream to restart. Connected stream targets may need to be restarted or reconnected.
- 4 STATUS LED:** This multi-function LED indicates the current video source selection, audio mixer state and RTMP streaming client (streaming to YouTube or Facebook) status.

LED State	Description
● RED	Video source is VGA
● BLUE	Video source is HDMI
● PURPLE	Video source is HDMI, Audio Mixer is enabled
Solid (any color)	RTMP streaming client is inactive
Blinking (any color)	RTMP streaming client is active

- 5 AUDIO MIXER BUTTON:** Press this button to enable/disable the Audio Mixer function when the video source is HDMI. The mixer's settings are configured within the WebGUI.
- 6 STOP BUTTON:** Press this button to stop streaming to the configured YouTube or Facebook target server. The Status LED will be lit solidly to indicate the stream is stopped.

- 7 PLAY BUTTON:** Press this button to start streaming to the configured YouTube or Facebook target server. The Status LED will blink to indicate the stream is currently active.

Note: The target streaming service (YouTube or Facebook) controlled by this button is defined in the WebGUI.

6.2 Rear Panel

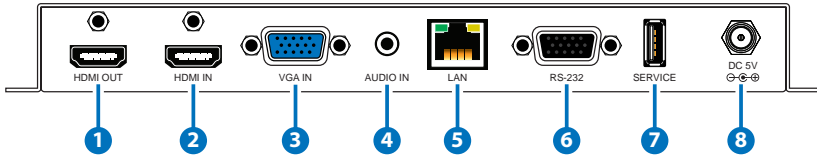

- 1 HDMI OUT PORT:** Connect to an HDMI TV, monitor or amplifier for digital video and audio output.
- 2 HDMI IN PORT:** Connect to HDMI source equipment such as a media player, game console or set-top box.
- Note: HDCP encrypted sources can not be streamed over the Internet and will be blacked out.*
- 3 VGA IN PORT:** Connect to VGA source equipment such as a PC or laptop.
- 4 AUDIO IN PORT:** Connect to the stereo analog output of a device such as a CD player or PC.
- 5 LAN PORT:** Connect to a network switch or router for transmission and distribution of streamed video as well as to control the unit via Telnet or WebGUI.
- Note: The maximum number of simultaneous stream connections is limited by available network bandwidth and the unit's CPU load.*
- 6 RS-232 PORT:** Connect directly to a PC, laptop or other serial control device to send RS-232 commands to control the unit.
- 7 SERVICE PORT:** This slot is reserved for firmware update use only.
- 8 DC 5V PORT:** Plug the 5V DC power adapter into this port and connect it to an AC wall outlet for power.

6.3 Remote Control

- 1 POWER BUTTON:** Press to power the unit on or place it into stand-by mode.
- 2 COUNTDOWN BUTTON:** Press to enable/disable the Countdown Timer display on the HDMI and streaming output.
- 3 PLAY & STOP BUTTONS:** Press to start/stop streaming to the configured YouTube or Facebook target server.
- 4 TEXT SCREEN BUTTON:** Press to enable/disable the "Text Screen" feature.
- 5 HDMI & VGA BUTTONS:** Press to select HDMI or VGA as the input source.
- 6 PICTURE QUALITY BUTTONS:** Press these buttons to change the bitrate and resolution of the YouTube/Facebook streaming output. Available options are:

BEST: 1080p@30fps, 3000Kbps

HIGH: 720p@30fps, 2000Kbps

NORMAL: VGA@15fps, 1500Kbps

Note: Changing the bitrate will force the video stream to restart.

- 7 - (MINUS), OK & + (PLUS) BUTTONS:** Press the OK button to start or stop the Countdown Timer. Press the + (PLUS) and - (MINUS) buttons to increase or decrease the remaining time in 30 second steps.
- 8 VOL- & VOL+ BUTTONS:** Press to increase or decrease the mixer output volume.
 - MIXER BUTTON:** Press to enable/disable the Audio Mixer function.
 - SWITCH BUTTON:** Press to toggle the audio source for the HDMI input between HDMI and analog stereo when the mixer is not enabled.
 - MUTE BUTTON:** Press to mute/unmute all audio output.

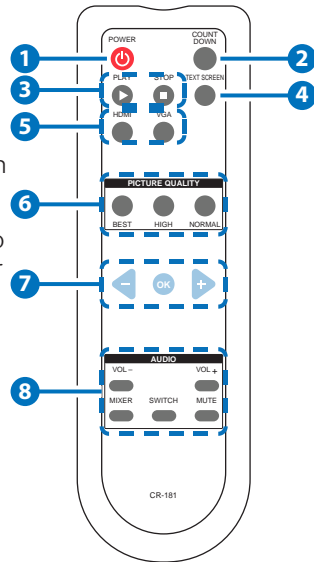

6.4 WebGUI Control

- **Device Discovery**

Please obtain the “Device Discovery” software from your authorized dealer and save it in a directory where you can easily find it.

Connect the unit and your PC/Laptop to the same active network and execute the “Device Discovery” software. Click on “Find Devices on Network” and a list of devices connected to the local network will show up indicating their current IP address.

Note: The unit’s default IP address is 192.168.1.50.

Product Name	Description	IP Address	MAC Address

By clicking on one of the listed devices you will be presented with the network details of that particular device.

Product ID
Product Name
MAC Address 00:00:00:00:00
IP Address
Subnet Mask
Gateway IP
DNS
IP Mode Static
Web GUI Port Static
Telnet Port 0
S / N
Firmware Version
Hardware Version
Description
Web GUI [Web GUI](#)
Save Reboot

- 1) **IP Mode:** If you choose, you can alter the static IP network settings for the device, or switch the unit into DHCP mode to automatically obtain proper network settings from a local DHCP server. To switch to DHCP mode, please select DHCP from the IP mode drop-down, then click “Save” followed by “Reboot”.
- 2) **WebGUI Hotkey:** Once you are satisfied with the network settings, you may use them to connect via Telnet or WebGUI. The network information window provides a convenient link to launch the WebGUI directly.

- **WebGUI Overview**

After connecting to the WebGUI's address in a web browser, the login screen will appear. Please enter the appropriate user name and password then click "Submit" to log in.

Note: The default user name and password is "admin".



On the left side of the browser you will see the following menu tabs where all primary functions of the unit are controllable via the built in WebGUI. The individual functions will be introduced in the following sections.

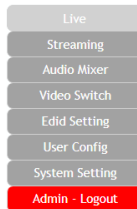

Clicking the red "Logout" tab will automatically log the currently connected user out of the WebGUI and return to login page.

6.4.1 Live Tab

This tab provides viewing access to, and control over, the first local video stream channel (of 4 channels total) generated by the unit. The video source, streaming resolution, streaming framerate and bitrate can be controlled directly here. At the bottom of the page, a connection address for video stream channel 1 is displayed in the format: "rtsp://nnn.nnn.nnn.nnn/live/ch1/h264_acc" (nnn.nnn.nnn.nnn = the unit's current IP address). When 3rd party video player software with RTSP streaming support is used to view streams from this unit, this is the URL that should be used to connect. To view streaming channels 2-4, change "ch1" in the address to "ch2", "ch3", or "ch4", as appropriate.

Note: Channels 2-4 contain the same video content presented at different streaming resolutions. Channel 2 matches the current settings from the "Streaming" tab, Channel 3 is 640×480@30fps, and Channel 4 is 320×240@30fps.

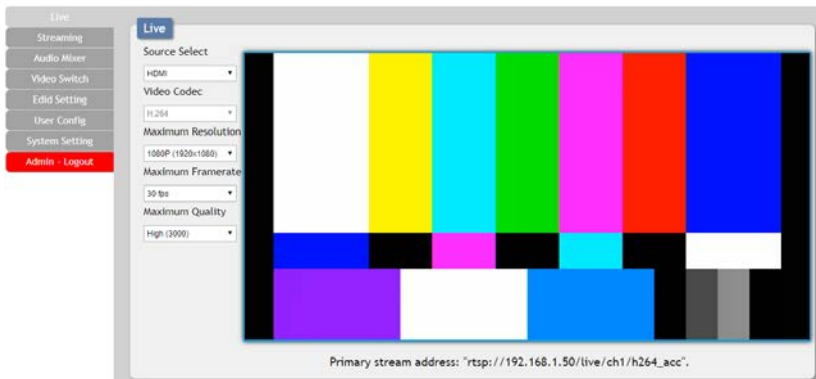

- 1) **Source Select:** Select the video input (HDMI or VGA) to stream.
Note: Changing the input here will change it globally across the unit.
- 2) **Video Codec:** Indicates the video codec used for the video stream.
Note: Currently, only H.264 is supported.
- 3) **Maximum Resolution:** Select the resolution to use for this video stream. Available resolutions are: 1080p(1920×1080), 720p(1280×720), VGA(640×480), or QVGA(320×240).

- 4) **Maximum Framerate:** Select the framerate to use for this video stream. Available framerates are: 60, 50, 30, or 25 frames per second.
- 5) **Maximum Quality:** Select the target bitrate for this video stream. Available bitrates are: 6000Kbps, 3000Kbps, or 2000Kbps.
- 6) **Video Window:** This video window displays the content of streaming channel 1 and provides the details of a direct connection address that can be used to connect to this stream using 3rd party video player software such as VLC or PotPlayer.

Note: Video streaming preview support within the WebGUI requires the use of the Chrome, Internet Explorer or Safari browser with the appropriate plugins (VLC for IE and Safari or VXG Player for Chrome) installed.

6.4.2 Streaming Tab

This tab provides access to the streaming settings to use when streaming directly to a YouTube or Facebook account as well as a way to start and stop the stream.

Note: This unit can only stream to a single dedicated service at a time. It is not possible to stream to both YouTube and Facebook simultaneously, however, all 4 local streaming channels are always active.





- 1) **Streaming Path:** Select the dedicated service (YouTube or Facebook) to stream to when the "Play" button, in the WebGUI or on the front of the unit, is pressed. Pressing the "Play" button will make the unit start streaming immediately and change label of the button to read "Stop". To stop streaming, press the "Stop" button.

Note: Both the Stream URL and Stream Key for the selected service must be set correctly for streaming to work. If the video stream is not connecting or not starting, please double check that those values have been entered correctly.

- 2) **Source Select (YouTube or Facebook):** Select the video input (HDMI or VGA) to stream.

Note: Changing the input here will change it globally across the unit.

- 3) **Maximum Video Resolution (YouTube or Facebook):** Select the resolution to use for the specified video stream. Available resolutions are: 1080p(1920×1080), 720p(1280×720), VGA(640×480), or QVGA(320×240).

- 4) **Maximum Video Framerate (YouTube or Facebook):** Select the framerate to use for the specified video stream. Available framerates are: 30 or 15 frames per second.

- 5) **Maximum Video Quality (YouTube or Facebook):** Select the target bitrate for the specified video stream. Available bitrates are: 3000Kbps, 2000Kbps, or 1500Kbps.

- 6) **Stream URL (YouTube or Facebook):** Please enter the Stream URL provided by the specified streaming service. This is the address of the specific target streaming server. Type the Stream URL EXACTLY as provided by the streaming service. The URL will start with "rtmp://", or "rtmps://" followed by the specific destination information of the server. Click on "Save" to confirm and store the Stream URL.

- 7) **Stream Key (YouTube or Facebook):** Please enter the Stream Key provided by the specified streaming service. This is an encrypted key that provides the streaming server with your unique login and identification credentials. Type the Stream Key EXACTLY as provided by the streaming service. A typical stream key is a very long string of letters, numbers and symbols. Click on "Save" to confirm and store the Stream Key.

Note: The Stream URL and Stream Key will be provided on the service's stream setup page. More information can be found within the help files of the specific service. Entering incorrect information will result in a failed connection.

6.4.3 Audio Mixer Tab

This tab allows for control over the Audio Mixer function of this unit. The Audio Mixer feature, when enabled, mixes the analog audio and HDMI audio inputs together with independently controllable volume levels.

Note: Only LPCM 2.0 audio from the HDMI source is supported by the mixer.

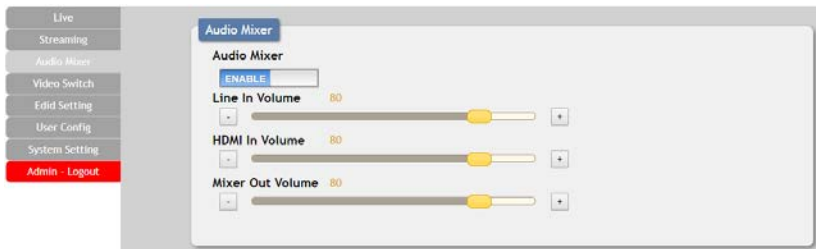

- 1) **Audio Mixer:** Enable or Disable the Audio Mixer function.
- 2) **Line In Volume:** Adjusts the volume of the analog audio source from 0% to 100%.
- 3) **HDMI In Volume:** Adjusts the volume of the HDMI audio source from 0% to 100%.
- 4) **Mixer Out Volume:** Adjusts the volume of the mixed audio output from 0% to 100%.

6.4.4 Video Switch Tab

This tab provides video/audio routing control as well as control over HDCP behavior, Input and Output names, Text Screen intermission details, and the Countdown Timer.

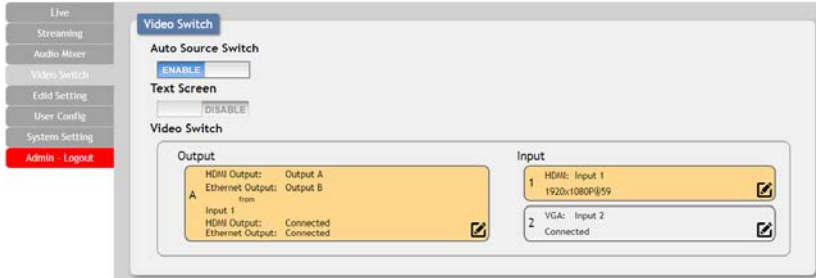

- 1) **Auto Source Switch:** Enable or disable the automatic input switching feature of this unit. When enabled, the unit will automatically switch to the most recently connected/detected input. If the current input's signal is lost, the unit will automatically switch to the other input.
- 2) **Text Screen:** The Text Screen intermission output can be used when the user wants to stream a simple text screen to indicate that there is not currently any live video to view. It may be enabled or disabled here.

Note: Enabling or disabling this feature may disconnect any currently connected streaming clients.

- 3) **Video Switch:** To assign a new video route, please click the Output button and then click on the button of the preferred Input port to route. As you select each button they will change their color to orange. The new route will become active immediately and the routing information displayed on the buttons will change accordingly.
 - **Output:** Click on this button to begin routing selection as detailed above. Click the EDIT icon (✎) to open the Output Edit window and modify additional Output settings.
 - **Input:** Rename either Input or modify the HDCP behavior (HDMI Input only) by clicking on the EDIT icon (✎) to open the editing window. Click on "Save" to confirm and activate any changes made to a name. Changes made to the HDCP behavior are

applied immediately. Available HDCP settings are:

Unit's Default HDCP Settings	
HDCP Support Off	Completely disables HDCP support on the input.
Refer to Source	HDCP support follows the HDCP mode required by the connected source device.
Refer to Display	HDCP support follows the HDCP mode supported by the connected sink.

- 4) **Output Edit:** This window is opened after clicking on the EDIT icon (✎) within the Output button and provides options to rename the Outputs, and configure the countdown timer and its associated OSD. Click on "Save" to confirm and activate any changes made to a name or to the countdown timer's default time. All other changes are immediate.

6.4.5 EDID Setting Tab

This tab provides the option of six standard EDIDs, one sink sourced EDID and four customer uploaded EDIDs that can be assigned to the HDMI input port. The names of the four customer uploaded EDIDs can be changed if desired.

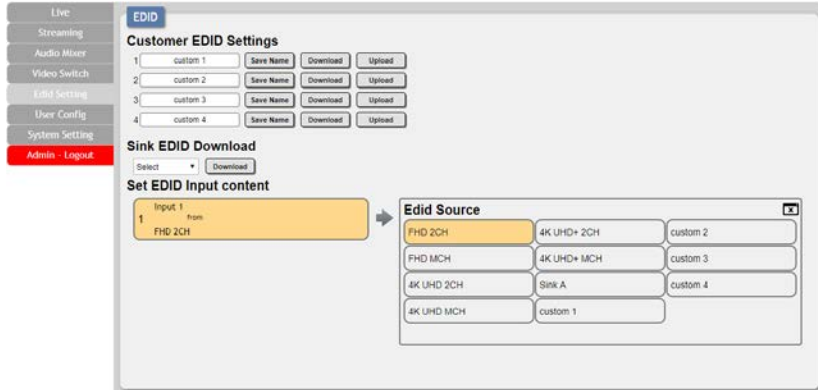

- 1) **Customer EDID Settings:** To upload a custom EDID, please click the “Upload” button next to the Customer EDID Settings item you would like to change. An EDID Upload window will appear, allowing you to locate and upload the preferred EDID file (*.bin format) from a local PC. Once the correct file has been selected, please click the “Upload” button in the window, and the file will be transferred to the unit.

To save an existing custom EDID to your local PC please press the “Download” button next to the EDID you would like to save. Depending on your browser settings you will either be asked where to save the downloaded file, or the file will be transferred to the default download location on your PC. To change the name of a custom EDID, type the new name in the space provided, then click on the “Save Name” button.

- 2) **Sink EDID Download:** To save the EDID from the connected HDMI display to your local PC, select the sink from the dropdown list then press the “Download” button. Depending on your browser settings you will either be asked where to save the downloaded file, or the file will be transferred to the default download location on your PC.

- 3) **Set EDID Input Content:** Click on the input button to open the EDID Source management window. Select the new EDID source to use, from the choices on the right, and the change will occur immediately.

Note: In most cases, assigning a new EDID to an input will cause the affected input to briefly blink out while the source adapts to the new information.

This unit provides the following 6 default EDIDs:

Unit's Default EDID Settings		
FHD/2CH	1920×1080p@60Hz (148MHz) & 8-bit color	LPCM 2.0
FHD/MCH	1920×1080p@60Hz (148MHz) & 8-bit color	LPCM 7.1 & Bitstream
UHD/2CH	3840×2160p@30Hz (297MHz) & Deep Color (8/10/12-bit)	LPCM 2.0
UHD/MCH	3840×2160p@30Hz (297MHz) & Deep Color (8/10/12-bit)	LPCM 7.1 & Bitstream
UHD+/2CH	3840×2160p@60Hz (594MHz) & Deep Color (8/10/12-bit)	LPCM 2.0
UHD+/MCH	3840×2160p@60Hz (594MHz) & Deep Color (8/10/12-bit)	LPCM 7.1 & Bitstream

Note: In some rare cases it is possible for custom or external EDIDs to cause compatibility issues with certain sources. If this happens, it is recommended to switch to one of the 6 default EDIDs for maximum compatibility.

6.4.6 User Configuration Tab

The WebGUI and Telnet username/password are set on this page. Two management levels are available: "Administrator" and "General User". The administrator username ("admin") cannot be changed.

Note: The "Administrator" user has access to all tabs and can change all settings. The "General User" only has access to the "Live" tab to allow easy remote video stream viewing.



6.4.7 System Setting Tab

This tab provides system information, power control, network configuration options, system configuration backup/restore/reset, and firmware update functions.

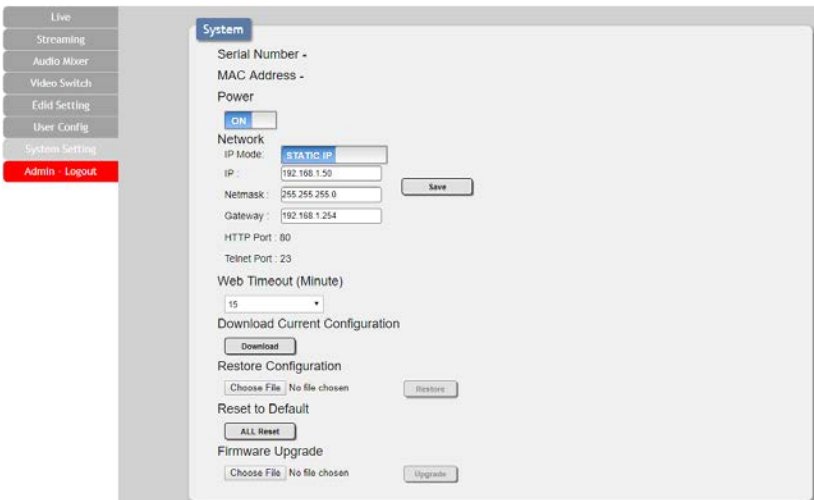

- 1) **Power:** Press this switch to toggle the unit's power between ON and OFF (standby mode).
Note: While in standby mode the unit's WebGUI, Telnet and RS 232 controls are still active.
- 2) **Network:** IP mode may be switched between Static IP or DHCP. In Static IP mode the IP, netmask and gateway addresses may be manually set. When in DHCP mode, the unit will attempt to connect to a local DHCP server and obtain IP, netmask and gateway addresses automatically. Please press "Save" after making any changes to the IP configuration or mode.
Note: The unit's default IP address is 192.168.1.50. If the IP address is changed then the IP address required for WebGUI/Telnet access will also change accordingly.
- 3) **Web Timeout:** Select the length of time to wait before logging the user out of the WebGUI due to inactivity. Available range is from 1 to 120 minutes.
- 4) **Download Current Configuration:** The current system configuration, including routing and settings, may be saved as an XML file to a PC. Click the "Download" button to save the current system configuration to your local PC.
- 5) **Restore Configuration:** Previously saved system configurations may be restored from a saved XML file. Click the "Choose File" button to locate the saved XML file, then click the "Restore" button.
- 6) **Reset to Default:** Press the "ALL Reset" button to reset the unit to its factory default state. After the reset is complete, the unit will reboot automatically.
- 7) **Firmware Upgrade:** To update the unit's firmware, click the "Choose File" button to open the file selection window and then select the firmware update file (*.bin format) located on your local PC. After selecting the file, click the "Upgrade" button to begin the firmware update process. After the upgrade is complete, the unit will reboot automatically.

6.4.8 Logout Tab

Clicking the red "Logout" tab will automatically log the currently connected user out of the WebGUI and return to login page.

6.5 RS-232 Control

Serial Port Default Settings	
Baud Rate	19200
Data Bits	8
Parity Bit	None
Stop Bits	1
Flow Control	None

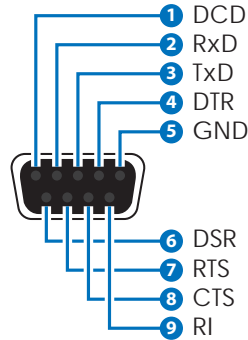

6.6 Telnet Control

Before attempting to use Telnet control, please ensure that both the unit and the PC are connected to the same active networks.

To Access the Command Line Interface (CLI)	
Windows 7	Click Start , type "cmd" in the search field, and press Enter .
Windows XP	Click Start > Run , type "cmd", and press Enter .
Mac OS X	Click Go > Applications > Utilities > Terminal .

Once in the Command Line Interface (CLI) type "**telnet**" followed by the IP address of the unit (and the port number if it is non-standard) and then hit "Enter". This will connect us to the unit we wish to control.

```
Microsoft Windows [Version 6.1.7601]
Copyright (c) 2009 Microsoft Corporation. All rights reserved.

C:\Users\Administrator>telnet 192.168.1.50 23
```

Note: The default IP address is 192.168.1.50. If the IP address is changed then the IP address required for Telnet access will also change accordingly.

6.7 RS-232 and Telnet Commands

COMMAND	
Description and Parameters	
HELP↵	Show all available commands.
?↵	Show all available commands.
GET FW VER↵	Show the unit's current firmware version.
GET MODEL NAME↵	Show the unit's model name.
GET MODEL TYPE↵	Show the unit's model type.
GET COMMAND VER↵	Show the unit's command protocol version.
GET MAC ADDR↵	Show the unit's MAC address.
GET USER CONFIG↵	List all current user configuration details.
SET FACTORY DEFAULT↵	Reset the unit to its factory defaults.
SET FACTORY IPCONFIG DEFAULT↵	Reset the unit's IP configuration to the factory defaults.
SET FACTORY OUT ROUTE DEFAULT↵	Reset the unit's routing to the factory defaults.
SET SYSTEM REBOOT↵	Reboot the unit.

COMMAND	
Description and Parameters	
SET POWER N1↵	
Power the unit on or place it into standby mode.	
Available values for N1 :	
1	[Power on]
2	[Standby mode]
ON	[Power on]
STANDBY	[Standby mode]
GET POWER↵	
Show the unit's current power state.	
SET IN N1 NAME N2↵	
Set the name for input N1 .	
Available values for N1 :	
1	[HDMI input]
2	[VGA input]
N2 = {name}	[32 characters max]
GET IN N1 NAME↵	
Show the current name for input N1 .	
SET OUT A NAME N1↵	
Set the name for the HDMI output.	
N1 = {name}	[32 characters max]
GET OUT A NAME↵	
Show the current name for the HDMI output.	
GET IN NAME LIST↵	
List the current names of all inputs.	
GET OUT NAME LIST↵	
List the current names of all outputs.	

COMMAND	
Description and Parameters	
SET OUT AUTO MODE N1↵	
Set the auto input switching mode.	
Available values for N1 :	
0	[Disabled]
1	[Auto Switch]
GET OUT AUTO MODE↵	
Show the current auto input switching state.	
GET OUT AUTO MODE LIST↵	
List all available auto mode options.	
GET IN N1 HACTIVE↵	
Show the current horizontal active pixel value of the source on input N1 .	
Available values for N1 :	
1	[HDMI input]
2	[VGA input]
<i>Notes: Values can only be read if the input is currently selected.</i>	
GET IN N1 VACTIVE↵	
Show the current vertical active pixel value of the source on input N1 .	
Available values for N1 :	
1	[HDMI input]
2	[VGA input]
<i>Notes: Values can only be read if the input is currently selected.</i>	

COMMAND					
Description and Parameters					
GET IN N1 REFRESH RATE↵					
<p>Show the current refresh rate of the source on input N1.</p> <p>Available values for N1:</p> <table> <tr> <td>1</td> <td>[HDMI input]</td> </tr> <tr> <td>2</td> <td>[VGA input]</td> </tr> </table> <p><i>Notes: Values can only be read if the input is currently selected.</i></p>		1	[HDMI input]	2	[VGA input]
1	[HDMI input]				
2	[VGA input]				
GET IN N1 INTERLACE↵					
<p>Show the current interlace state of the source on input N1.</p> <p>Available values for N1:</p> <table> <tr> <td>1</td> <td>[HDMI input]</td> </tr> <tr> <td>2</td> <td>[VGA input]</td> </tr> </table> <p><i>Notes: Values can only be read if the input is currently selected.</i></p>		1	[HDMI input]	2	[VGA input]
1	[HDMI input]				
2	[VGA input]				
GET IN N1 SYNC STATUS↵					
<p>Show the current sync state of the source on input N1.</p> <p>Available values for N1:</p> <table> <tr> <td>1</td> <td>[HDMI input]</td> </tr> <tr> <td>2</td> <td>[VGA input]</td> </tr> </table> <p><i>Notes: Values can only be read if the input is currently selected.</i></p>		1	[HDMI input]	2	[VGA input]
1	[HDMI input]				
2	[VGA input]				
GET IN N1 TIMING↵					
<p>Show the current timing data of the source on input N1.</p> <p>Available values for N1:</p> <table> <tr> <td>1</td> <td>[HDMI input]</td> </tr> <tr> <td>2</td> <td>[VGA input]</td> </tr> </table> <p><i>Notes: Values can only be read if the input is currently selected.</i></p>		1	[HDMI input]	2	[VGA input]
1	[HDMI input]				
2	[VGA input]				
GET IN TYPE LIST↵					
<p>List all available input ports and their types.</p>					
GET OUT TYPE LIST↵					
<p>List all available output ports and their types.</p>					

COMMAND	
Description and Parameters	
SET ALL OUT ROUTE N1↵	
Select the input to route to all outputs.	
Available values for N1 :	
1	[HDMI input]
2	[VGA input]
GET ALL OUT ROUTE↵	
Show the input currently routed to all outputs.	
GET IN PORT NUMBER↵	
Show the total number of available input ports.	
GET OUT PORT NUMBER↵	
Show the total number of available output ports.	
GET OUT A SYNC STATUS↵	
Show the current sync state of the HDMI output.	
GET OUT TIMING LIST↵	
List all supported video timings with their local index number.	
SET AUDIO OUT ALL MUTE N1↵	
Enable or disable muting the audio on all outputs.	
Available values for N1 :	
ON	[Mute enabled]
OFF	[Mute disabled]
GET AUDIO OUT A MUTE↵	
Show the current audio output mute state.	
SET AUDIO OUT A ROUTE N1↵	
Select the audio source to use with the HDMI input.	
Available values for N1 :	
1	[HDMI audio]
2	[Analog audio]

COMMAND	
Description and Parameters	
GET AUDIO OUT A ROUTE↵	
	Show the current audio source used with the HDMI input.
GET AUDIO IN TYPE LIST↵	
	List all available audio source types.
GET AUDIO OUT TYPE LIST↵	
	List all available audio output types.
SET AUDIO MIXER N1↵	
	Enable or disable the audio mixer.
	Available values for N1 :
ON	[Mixer enabled]
OFF	[Mixer disabled]
GET AUDIO MIXER↵	
	Show the current state of the audio mixer.
SET AUDIO MIXER IN N1 VOLUME N2↵	
	Set the mixer volume level for audio input N1 .
	Available values for N1 :
1	[HDMI audio]
2	[Analog audio]
N2 = 0 - 100	[Volume level]
GET AUDIO MIXER IN N1 VOLUME↵	
	Show the current mixer volume level for audio input N1 .
	Available values for N1 :
1	[HDMI audio]
2	[Analog audio]
SET AUDIO MIXER OUT A VOLUME N1↵	
	Set the master output volume level for the audio mixer.
N1 = 0 - 100	[Volume level]

COMMAND	
Description and Parameters	
GET AUDIO MIXER OUT A VOLUME↵	
	Show the current master output volume level for the audio mixer.
SET ENCODER 1 PROFILE N1 RESOLUTION N2↵	
	Set the resolution for streaming channel N1 .
N1 = 1 ~ 4	[Streaming channel]
Available values for N2 :	
1920×1080	[Streaming resolution]
1280×720	[Streaming resolution]
640×480	[Streaming resolution]
320×240	[Streaming resolution]
GET ENCODER 1 PROFILE N1 RESOLUTION↵	
	Show the currently set resolution for streaming channel N1 .
SET ENCODER 1 PROFILE N1 BITRATE N2↵	
	Set the maximum bitrate (in Kbps) for streaming channel N1 .
N1 = 1 ~ 4	[Streaming channel]
N2 = 1 ~ 6000	[Max bitrate in Kbps]
GET ENCODER 1 PROFILE N1 BITRATE↵	
	Show the currently set maximum bitrate for streaming channel N1 .
SET ENCODER 1 PROFILE N1 FRAMERATE N2↵	
	Set the frame rate for streaming channel N1 .
N1 = 1 ~ 4	[Streaming channel]
N2 = 1 ~ 60	[Frames per second]
GET ENCODER 1 PROFILE N1 FRAMERATE↵	
	Show the currently set frame rate for streaming channel N1 .

COMMAND	
Description and Parameters	
SET IN 1 EDID N1↵	
Set the EDID to use with the HDMI input.	
Available values for N1 :	
1	[FHD 2CH]
2	[FHD MCH]
3	[4K UHD 2CH]
4	[4K UHD MCH]
5	[4K UHD+ 2CH]
6	[4K UHD+ MCH]
7	[Sink A]
8	[User 1]
9	[User 2]
10	[User 3]
11	[User 4]
GET IN 1 EDID↵	
Show the currently selected EDID used by the HDMI input.	
GET IN EDID LIST↵	
List all available EDID selections.	
SET USER N1 EDID DATA N2↵	
Upload a new EDID in HEX format for use as User EDID N1 .	
N1 = 1 ~ 4	[User EDID number]
N2 = {EDID data in hh, hh, hh, hh, ... HEX pair format}	
GET USER N1 EDID DATA↵	
Show the current User EDID N1 as HEX data.	
N1 = 1 ~ 4	[User EDID number]
GET SINK A EDID DATA↵	
Show the EDID from the currently connected HDMI display as HEX data.	

COMMAND	
Description and Parameters	
GET IN 1 EDID DATA↵	
Show the EDID currently used by the HDMI input as HEX data.	
GET ALL IN EDID LIST↵	
List the EDIDs assigned to all inputs.	
GET INTERNAL N1 EDID DATA↵	
Show Internal EDID N1 as HEX data.	
N1 = 1 ~ 6	[Internal EDID number]
SET IN 1 HDCP MODE N1↵	
Set the HDMI input's HDCP behavior.	
Available values for N1 :	
0	[Disable HDCP]
1	[Follow source]
2	[Follow display]
GET IN 1 HDCP MODE↵	
Show the unit's current HDCP behavior setting.	
GET IN 1 HDCP STATUS↵	
Show the current status of HDCP on the Input.	
GET OUT N1 HDCP STATUS↵	
Show the current status of HDCP on Output N1 .	
Available values for N1 :	
A	[HDMI output]
B	[LAN output]
SET OUT A OSD N1↵	
Enable or disable the OSD Countdown Timer banner.	
Available values for N1 :	
ON	[OSD on]
OFF	[OSD off]

COMMAND	
Description and Parameters	
GET OUT A OSD↵	
	Show the current state of the OSD Countdown Timer banner.
SET OUT A BANNER FONT SIZE N1↵	
	Set the size of the text in the OSD Countdown Timer banner.
	Available values for N1 :
1	[Normal size]
2	[Double size]
3	[Quadruple size]
GET OUT A BANNER FONT SIZE↵	
	Show the current OSD Countdown Timer banner text size.
SET OUT A BANNER FONT COLOR N1↵	
	Set the font color for the OSD Countdown Timer banner.
	Available values for N1 :
BLACK	[Text color]
WHITE	[Text color]
RED	[Text color]
GREEN	[Text color]
BLUE	[Text color]
MAGENTA	[Text color]
YELLOW	[Text color]
CYAN	[Text color]
GRAY	[Text color]
GET OUT A BANNER FONT COLOR↵	
	Show the current font color for the OSD Countdown Timer banner.
GET OUT BANNER FONT COLOR LIST↵	
	List all available OSD font colors.

COMMAND	
Description and Parameters	
SET OUT A BANNER FONT TRANSPARENCY LEVEL N1↵	
Set the background transparency level for the OSD Countdown Timer banner.	
N1 = 1 ~ 8	[Transparency level]
GET OUT A BANNER FONT TRANSPARENCY LEVEL↵	
Show the current background transparency level for the OSD Countdown Timer banner.	
SET OUT A OSD BACKGROUND COLOR N1↵	
Set the background color for the OSD Countdown Timer banner.	
Available values for N1 :	
BLACK	[Background color]
WHITE	[Background color]
RED	[Background color]
GREEN	[Background color]
BLUE	[Background color]
MAGENTA	[Background color]
YELLOW	[Background color]
CYAN	[Background color]
GRAY	[Background color]
GET OUT A OSD BACKGROUND COLOR↵	
Show the current background color for the OSD Countdown Timer banner.	
GET OUT OSD BACKGROUND COLOR LIST↵	
List all available OSD background colors.	
SET OUT A COUNTDOWN TIMER N1↵	
Set the default time value of the OSD Countdown Timer in seconds.	
N1 = 0 ~ 86400	[Time in seconds]

COMMAND	
Description and Parameters	
GET OUT A COUNTDOWN TIMER↵	
Show the default Countdown Timer time value in seconds.	
SET UART 1 BAUDRATE N1↵	
Set the RS-232 baud rate.	
Available values for N1 :	
4800	[Baud rate]
7200	[Baud rate]
9600	[Baud rate]
14400	[Baud rate]
19200	[Baud rate]
38400	[Baud rate]
57600	[Baud rate]
115200	[Baud rate]
GET UART 1 BAUDRATE↵	
Show the unit's current RS-232 baud rate.	
GET UART LIST↵	
List all available RS-232 ports.	
SET UART 1 RESET↵	
Reset the unit's RS-232 configuration to the factory defaults.	
SET IP MODE N1↵	
Set the IP address assignment mode.	
Available values for N1 :	
0	[Static IP mode]
1	[DHCP mode]
STATIC	[Static IP mode]
DHCP	[DHCP mode]
GET IP MODE↵	
Show the unit's current IP address assignment mode.	

COMMAND	
Description and Parameters	
GET IPCONFIG↵	Show the unit's current IP address details.
SET IPADDR N1↵	Set the unit's static IP address. N1 = X.X.X.X [X = 0 ~ 255]
GET IPADDR↵	Show the unit's current IP address.
SET NETMASK N1↵	Set the unit's netmask address. N1 = X.X.X.X [X = 0 ~ 255]
GET NETMASK↵	Show the unit's current netmask.
SET GATEWAY N1↵	Set the unit's gateway address. N1 = X.X.X.X [X = 0 ~ 255]
GET GATEWAY↵	Show the unit's current gateway address.

Note: Commands will not be executed unless followed by a carriage return. Commands are not case-sensitive.

7. CONNECTION DIAGRAM

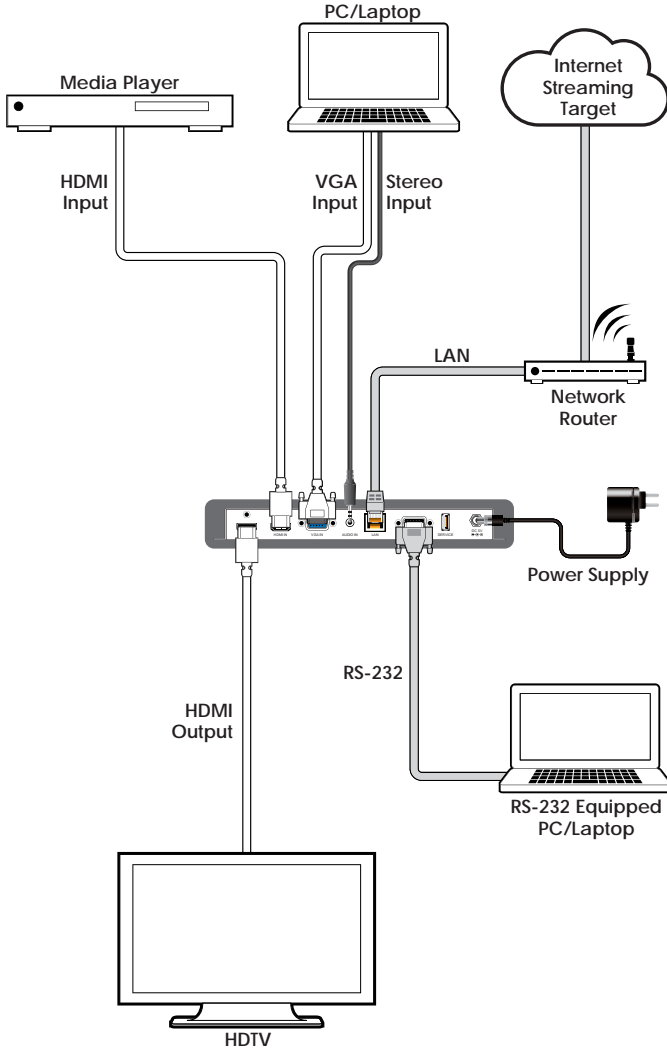

8. SPECIFICATIONS

8.1 Technical Specifications

HDMI Bandwidth	600MHz/18Gbps
Input Ports	1×HDMI 1×VGA (HD-15) 1×Stereo (3.5mm)
Output Port	1×HDMI
Control/Data Ports	1×RS-232 (DE-9) 1×LAN (RJ-45)
Baud Rate	19200bps
Power Supply	5V/3A DC (US/EU standards, CE/FCC/UL certified)
ESD Protection	Human Body Model: ±8kV (Air Discharge) ±4kV (Contact Discharge)
Dimensions	231.5mm×25mm×108mm (W×H×D) [Case Only] 231.5mm×25mm×117mm (W×H×D) [All Inclusive]
Weight	668g
Chassis Material	Metal (Steel)
Silkscreen Color	Black
Operating Temperature	0 °C–40 °C/32 °F–104 °F
Storage Temperature	-20 °C–60 °C/-4 °F–140 °F
Relative Humidity	20–90% RH (Non-condensing)
Power Consumption	9.24W

8.2 Video Specifications

Supported Resolutions (Hz)	Streaming Support		Output	
	HDMI Input	VGA Input	HDMI Bypass	H.264 Stream
320×240@25/30/50/60	x	x	x	✓
720×400@85	✓	x	✓	x
720×480p@60	✓	✓	✓	x
640×480@25/30/50/60	60	60	60	✓
640×480@72/75/85	✓	✓	✓	x
720×576p@50	✓	✓	✓	x
800×600@56/60/72/75/85	✓	✓	✓	x
1280×720@25/30/50/60	50/60	50/60	50/60	✓
1024×768@60/70/75/85	✓	✓	✓	x
1280×768@60/75	✓	✓	✓	x
1360×768@60	✓	x	✓	x
1366×768@60	✓	✓	✓	x
1280×800@60	✓	✓	✓	x
1152×864@75	✓	✓	✓	x
1440×900@60	✓	✓	✓	x
1600×900@60	✓	x	✓	x
1280×960@60	✓	✓	✓	x
1280×1024@60	✓	✓	✓	x
1400×1050@60	x	x	✓	x
1680×1050@60/60 (RB)	✓	✓	✓	x
1920×1080i@50/60	x	x	✓	x
1920×1080p@24	✓	✓	✓	x
1920×1080p@25/30/50/60	✓	✓	✓	✓

Supported Resolutions (Hz)	Streaming Support		Output	
	HDMI Input	VGA Input	HDMI Bypass	H.264 Stream
1600×1200@60	✓	✓	✓	×
1920×1200@60 (RB)	×	×	✓	×
2560×1600@60 (RB)	×	×	✓	×
2560×1440@60 (RB)	×	×	✓	×
3840×2160@24/25/30	✓	×	✓	×
3840×2160@50/60 (4:4:4)	✓	×	✓	×
3840×2160@50/60 (4:2:0)	✓	×	✓	×
4096×2160@24/25/30	✓	×	✓	×
4096×2160@50/60 (4:4:4)	✓	×	✓	×
4096×2160@50/60 (4:2:0)	✓	×	✓	×

8.3 Audio Specifications

Analog Input	
Max Audio Level	2Vrms
Impedance	20kΩ
Type	Unbalanced

8.4 Cable Specifications

HDMI Cable Length	1080p		4K30	4K60
	8-bit	12-bit	8-bit	8-bit
Input	10m	10m	5m	3m
Output	10m	10m	5m	3m

9. ACRONYMS

ACRONYM	COMPLETE TERM
CLI	Command-Line Interface
CPU	Central processing unit
DHCP	Dynamic Host Configuration Protocol
EDID	Extended Display Identification Data
FHD	Full-High-Definition
GUI	Graphical User Interface
HDCP	High-bandwidth Digital Content Protection
HDMI	High-Definition Multimedia Interface
HDTV	High-Definition Television
IP	Internet Protocol
LAN	Local Area Network
LED	Light-Emitting Diode
LPCM	Linear Pulse-Code Modulation
ONVIF	Open Network Video Interface Forum
OSD	On-Screen Display
PC	Personal Computer
QVGA	Quarter Video Graphics Array
RTP	Real-time Transport Protocol
RTMP	Real-Time Messaging Protocol
RTSP	Real-Time Streaming Protocol
UHD	Ultra-High-Definition
URL	Uniform Resource Locator
USB	Universal Serial Bus
VGA	Video Graphics Array
WUXGA (RB)	Widescreen Ultra Extended Graphics Array (Reduced Blanking)
XML	Extensible Markup Language



CYPRESS TECHNOLOGY CO., LTD.

www.cypress.com.tw