



CETH-4HDI

Ethernet/USB PC 4-Port HDMI Converter/Extender



Operation Manual

DISCLAIMERS

The information in this manual has been carefully checked and is believed to be accurate. Cypress Technology assumes no responsibility for any infringements of patents or other rights of third parties which may result from its use.

Cypress Technology assumes no responsibility for any inaccuracies that may be contained in this document. Cypress also makes no commitment to update or to keep current the information contained in this document.

Cypress Technology reserves the right to make improvements to this document and/or product at any time and without notice.

COPYRIGHT NOTICE

No part of this document may be reproduced, transmitted, transcribed, stored in a retrieval system, or any of its part translated into any language or computer file, in any form or by any means—electronic, mechanical, magnetic, optical, chemical, manual, or otherwise—without express written permission and consent from Cypress Technology.

© Copyright 2011 by Cypress Technology.

All Rights Reserved.

Version 1.1 August 2011

TRADEMARK ACKNOWLEDGMENTS

All products or service names mentioned in this document may be trademarks of the companies with which they are associated.





SAFETY PRECAUTIONS

Please read all instructions before attempting to unpack, install or operate this equipment and before connecting the power supply.

Please keep the following in mind as you unpack and install this equipment:

- Always follow basic safety precautions to reduce the risk of fire, electrical shock and injury to persons.
- To prevent fire or shock hazard, do not expose the unit to rain, moisture or install this product near water.
- Never spill liquid of any kind on or into this product.
- Never push an object of any kind into this product through any openings or empty slots in the unit, as you may damage parts inside the unit.
- Do not attach the power supply cabling to building surfaces.
- Use only the supplied power supply unit (PSU). Do not use the PSU if it is damaged.
- Do not allow anything to rest on the power cabling or allow any weight to be placed upon it or any person walk on it.
- To protect the unit from overheating, do not block any vents or openings in the unit housing that provide ventilation and allow for sufficient space for air to circulate around the unit.

REVISION HISTORY

VERSION NO.	DATE DD/MM/YY	SUMMARY OF CHANGE
VR0	28/04/11	Preliminary Release
VS1	07/05/13	Updated format/diagrams



CONTENTS

1. Introduction	1
2. Applications	1
3. Package Contents	1
4. System Requirements	2
5. Features	2
6. Operation Controls and Functions	3
6.1 Front Panel.....	3
6.2 Rear Panel	4
7. Software Installation	5
7.1 Installing the DisplayLink Software ..	5
7.2 Installing the USB Server Software ...	6
7.3 Using the USB Server.....	7
8. Using DisplayLink Manager	8
8.1 Using DisplayLink Manager	8
8.2 Using Additional DisplayLink Managers.....	13
9. Uninstalling the Device Driver	14
10. Connection Diagram	16
11. Specifications	18
12. Acronyms	19





1. INTRODUCTION

The Ethernet/USB to 4 Port HDMI Converter allows the user to display the output from a PC/Laptop on up to four TV/Monitors either by direct connection (via USB or CAT cable) or over a network connection.

For the home, it makes it easy to have multiple screens for browsing the internet, editing word processor documents or playing music or movies simultaneously on all connected displays.

In the workplace, it can allow attendees in a meeting room to access the display from their laptop over a network without having to fumble with cables or it can display a single advertisement stretched over 4 displays to distances of up to 100m.

It can also be used as a simple USB to HDMI signal converter through its USB 2.0 connection. Each HDMI output can display different content, mirror the main screen or can even stretch the image over 4 screens to create a videowall.

2. APPLICATIONS

- Multi-user PC gameplay
- Multi-screen showroom installation
- Local four screen PC desktop extending
- Multi-screen educational display
- Remote PC viewing

3. PACKAGE CONTENTS

- Ethernet/USB to 4 Port HDMI Converter
- 5V/2.6A DC Power Adaptor
- Driver CD
- Operation Manual

4. SYSTEM REQUIREMENTS

- System Hardware Requirements: 2.4GHz single core CPU with at least 1 GB of RAM for optimal performance.
- Operating Systems: Windows XP SP2, Vista (32-bit) & Windows 7
- USB Port Extension: An available USB 2.0 port with USB to mini-USB cable
- Network Extension: An available Ethernet port on a home or work network with CAT5e/6 cable

Notes: The device's ethernet extender mode is not supported in MAC OS. The USB mode is supported by Mac OS X v10.4.11 and v10.5.6.

5. FEATURES

- Displays content on up to 4 HDMI displays over a network or directly from PC/Laptop with USB connection
- Supports HD resolutions up to 1920×1080 for each HDMI output
- Individual EDID selection (INT/EXT) for output display control
- USB 2.0 (Hi-speed) compliant
- Supports Gigabit Ethernet TCP/IP protocols
- 3.5mm mini-jack external input for embedding HDMI audio
- Extend or mirror audio and video through a network or USB cable on up to 4 HDMI displays
- Supports 16/32-bit Color for high-quality display
- Adds four HDMI displays to your computer through a single USB 2.0 port
- Share four HDMI display with multiple users through an existing network (up to 100m)
- Supports Individual display resolution on each HDMI output

6. OPERATION CONTROLS AND FUNCTIONS

6.1 Front Panel

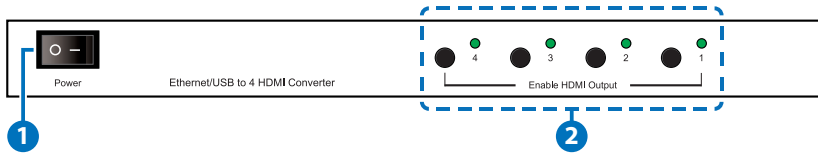

- 1 Power Switch:** Turns the system ON or OFF.
- 2 Enable HDMI Output and LED Indicators:** Press the HDMI output enable button to enable or disable the corresponding HDMI output ports. When enabled, the LED for the corresponding HDMI output port will illuminate blue.

6.2 Rear Panel

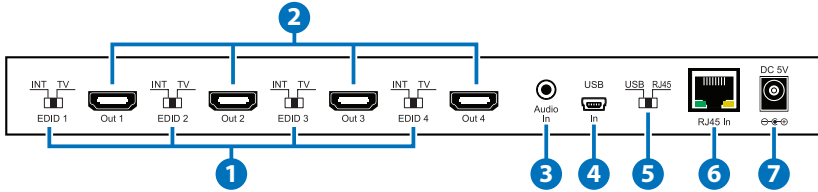

- 1 EDID Control Switch:** Use the EDID control switches to determine which EDID setting the unit will use for that HDMI output. When the switch is set to TV, the EDID settings from the TV will be used. When switched to INT, the unit's own EDID settings will be used. The factory default setting is TV mode for all outputs.
- 2 HDMI Output 1/2/3/4:** Connect each of the output ports to an HDMI display. The system can mirror the same screen on each HDMI output, display different content on each screen or you can extend the screen to cover all four HDMI displays. For more detail please check section 8 (Using DisplayLink Manager) for mirror or video extension settings.
- 3 Audio In:** Connect to the PC's audio output with a 3.5 mini-jack cable. The audio will be output through the HDMI outputs.
- 4 Mini-USB In:** Use for a direct connection to the PC in USB mode.
- 5 USB/RJ45 Input Switch:** Switches between Direct USB mode or Network/RJ45 mode.
- 6 RJ45 In:** Connect with CAT5e/6 cable to a network or directly to a PC/Laptop.
- 7 DC 5V:** Connect the 5V DC power supply to the unit and plug the adaptor into an AC wall outlet.



7. SOFTWARE INSTALLATION

The following sections list the procedures for installing the USB to HDMI and USB device drivers. Insert the CD (included in the package) into your CD-ROM drive, then begin the USB Install Disc and follow the below steps to install the driver and software.

7.1 Installing the DisplayLink Software

Insert the CD driver included in the package and double click on the DisplayLink icon to execute the setup.

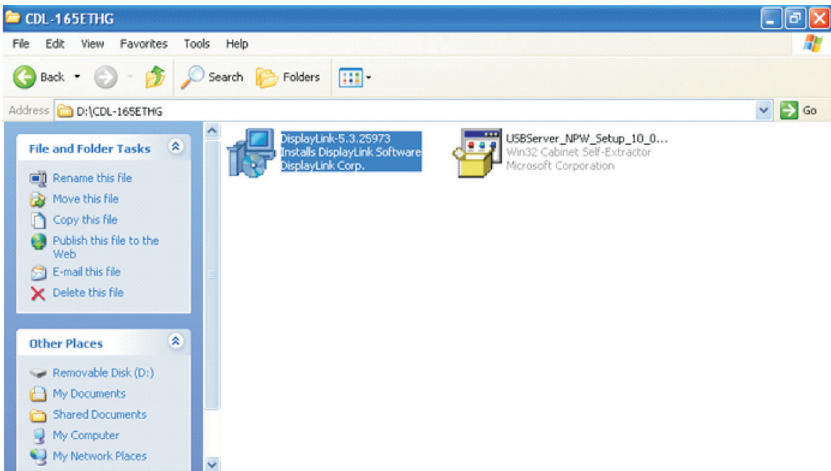

7.2 Installing the USB Server Software

Double click on the USBServer Setup icon to execute the set up and click finish when the setup is complete.

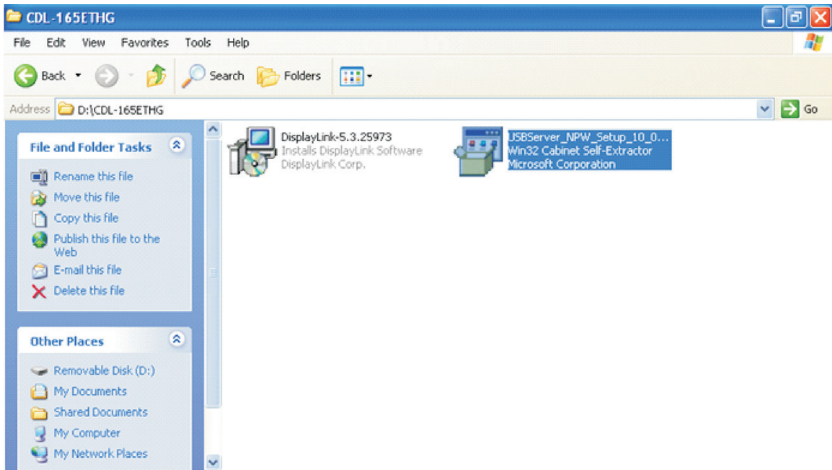

When both DisplayLink and USBServer has been installed completely the USB Server's icon should appear on the desktop and in the system tray on the right hand side of the desktop.

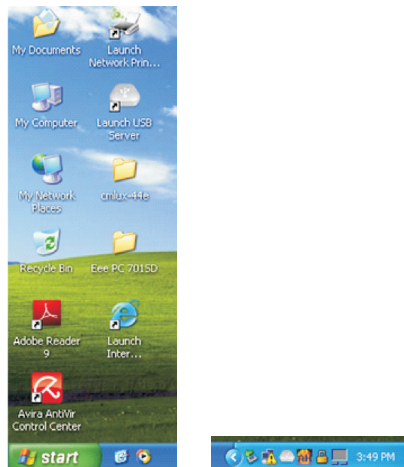



7.3 Using the USB Server

Double click the USB Server icon on the desktop or in the system tray to launch the USB Server software. Connect the unit to the PC directly via USB or CAT cable or via CAT cable through a Router or network switch then press the 'Enable' button (on the front panel of the display) for each of the connected displays to enable them.

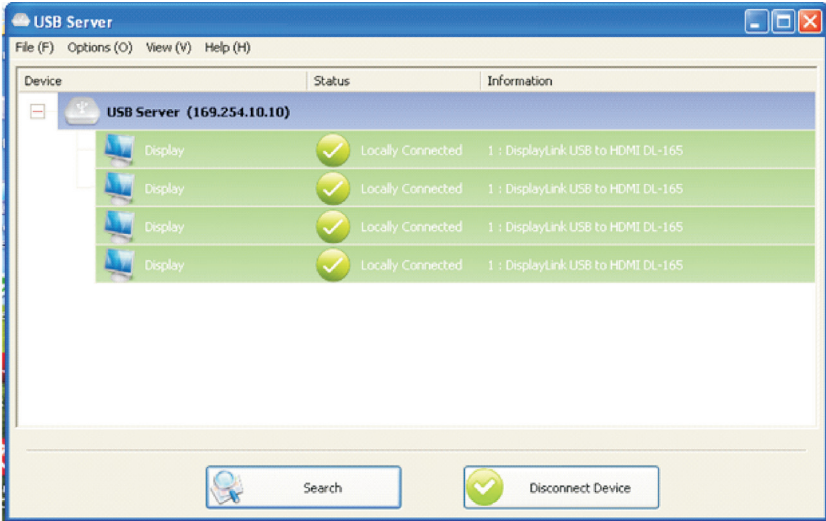

Once this connection is done click the "Connect Device" button in the USB Server window. When the connection is done the Status will have a "✓" mark next to it. To disconnect click on "Disconnect Device".

8. USING DISPLAYLINK MANAGER

8.1 Using DisplayLink Manager

After the driver is installed, the DisplayLink Manager utility will automatically appear in the system tray. Right clicking on the icon will bring up the context menu where you can quickly change the settings such as screen rotation and resolution.

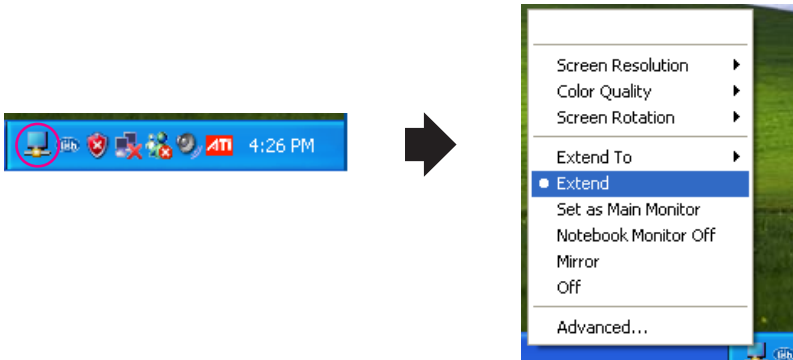

■ **Screen Resolution:** Select the screen resolution (available only in extended mode).

NOTE: When the display has a built in EDID the screen will show the display's resolution, if no EDID is present the screen has the following resolution (see the image below)

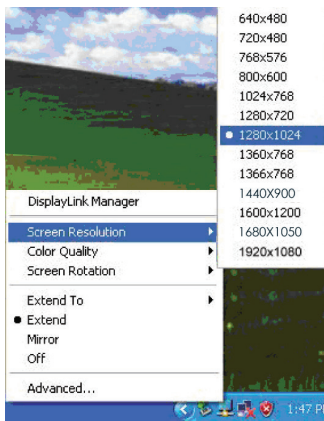

■ **Color Quality:** Select the screen color quality (available only in extended mode).

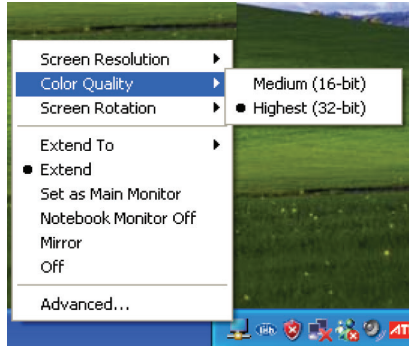

■ **Screen Rotation:** Rotate the screen on the additional monitor by 90, 180 or 270 degrees.

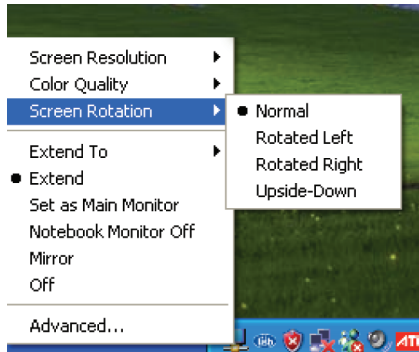

■ **Extend to:** Reposition the extended screen to the top, bottom, left or right of the primary display.

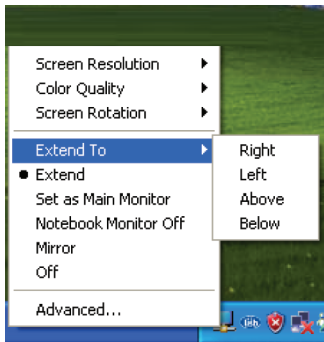

■ **Extend:** Set the DisplayLink Manager to Extended mode.

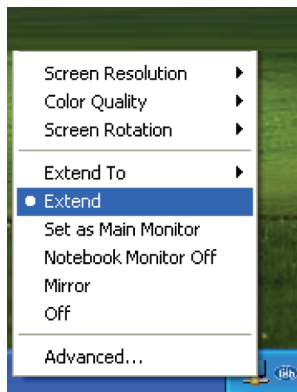

- **Set as Main Monitor:** Set the monitor to be the main monitor.

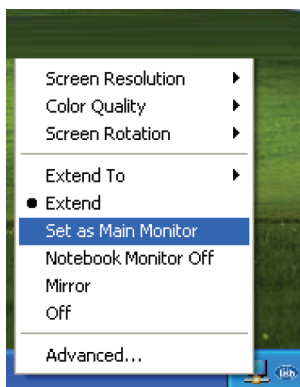

- **Notebook Monitor off:** Set the PC/notebook's monitor off.

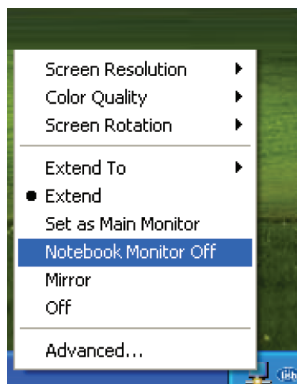

- **Mirror:** Set the DisplayLink Manager to Mirror mode. You can see the same desktop image on the additional monitor.

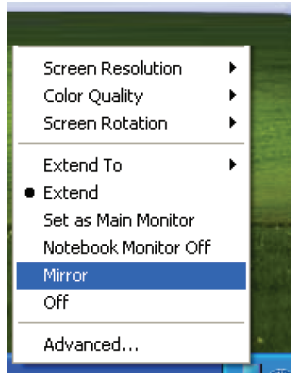

- **Off:** Disable the DisplayLink Manager on the system.

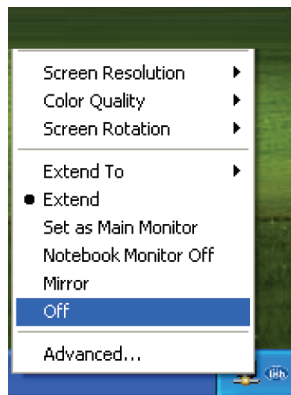

■ **Advanced:** Opening the Display Properties will allow you to adjust the resolution, color quality, position and refresh rate.

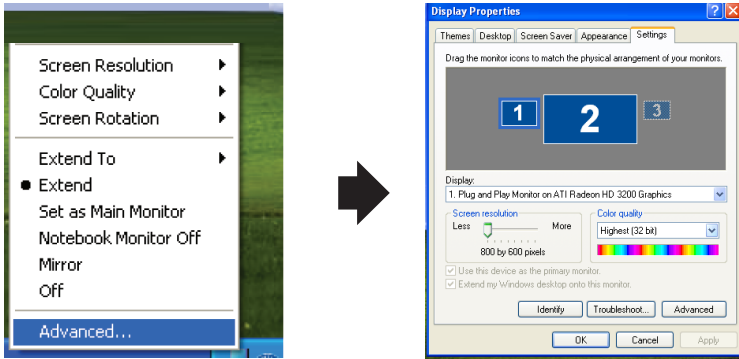

8.2 Using Additional DisplayLink Managers

You don't have to install a new driver as long as you have completed the above installation process in advance. It will automatically define the ID of the new Display Link Manager and will list everything in the Display properties or the display manager menu.



NOTE: When connecting additional DisplayLink Devices to a computer, a system with higher CPU performance is recommended.

9. UNINSTALLING THE DEVICE DRIVER

Follow the steps below to uninstall the driver.

Step 1: To open the Control Panel: Click on Start → Control Panel → Add or Remove Programs.

Step 2: Select DisplayLink Core Software and click Remove.

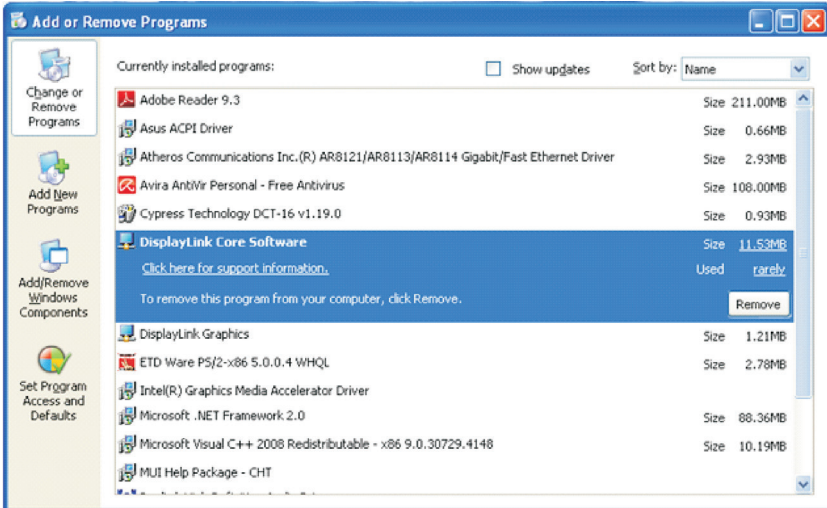

Step 3: Click Yes to confirm the removal.



Step 4: Click Yes to restart your computer.

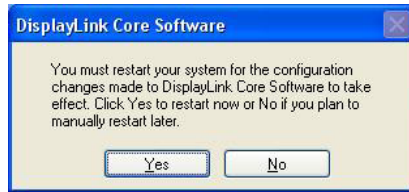

Then select DisplayLink Graphics and click Remove. Finally, select USB Server and click Remove.

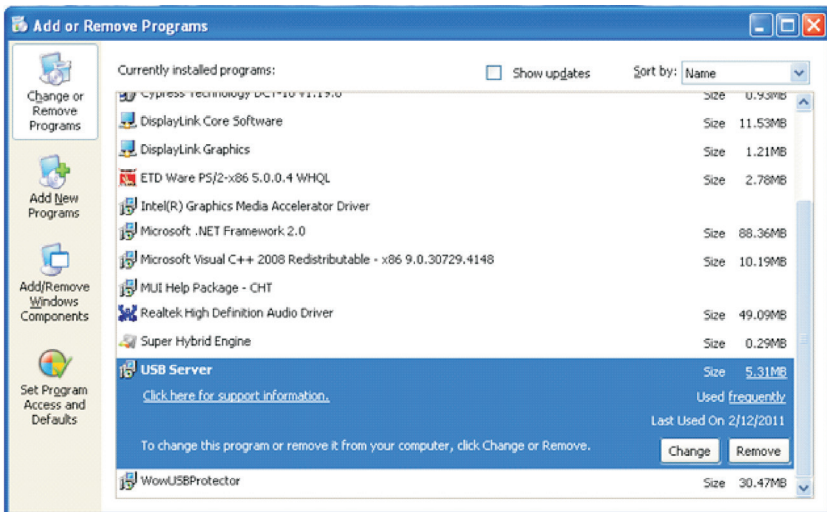

10. CONNECTION DIAGRAM

Example 1: Extender Mode

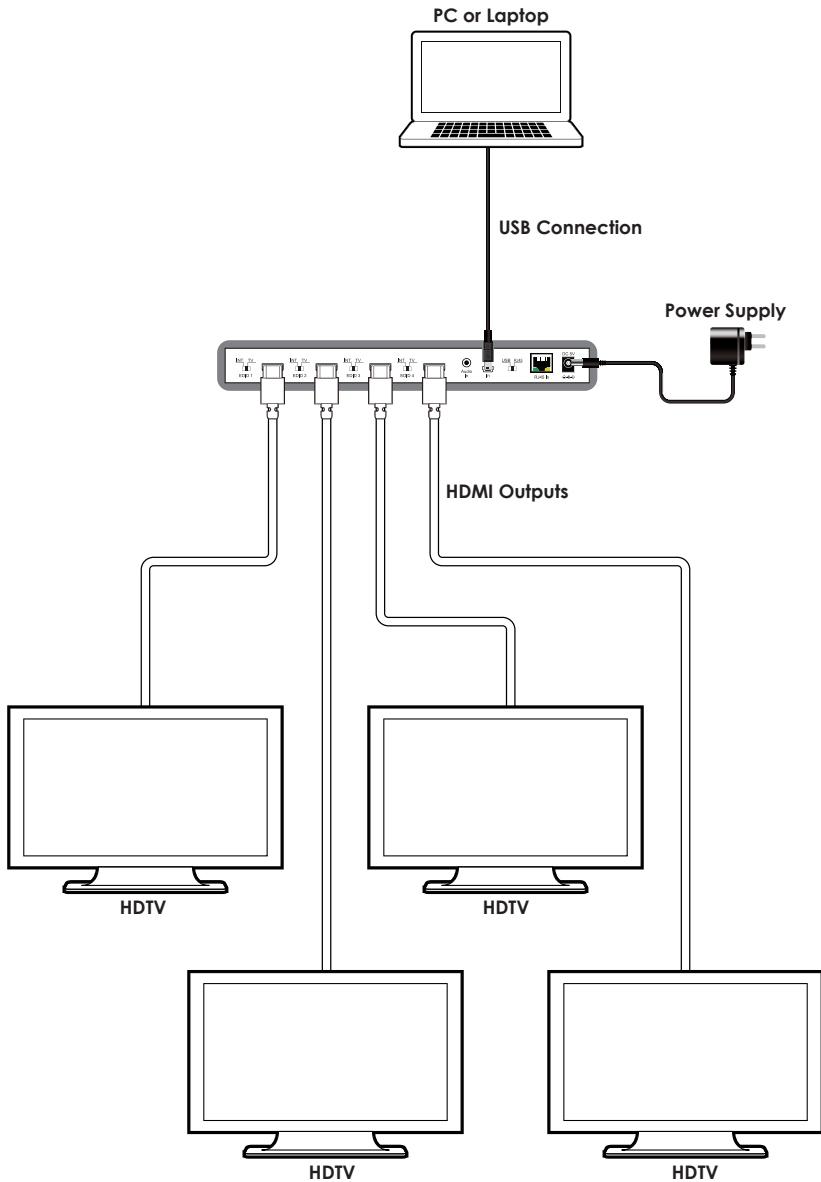

Example 2: LAN Mode

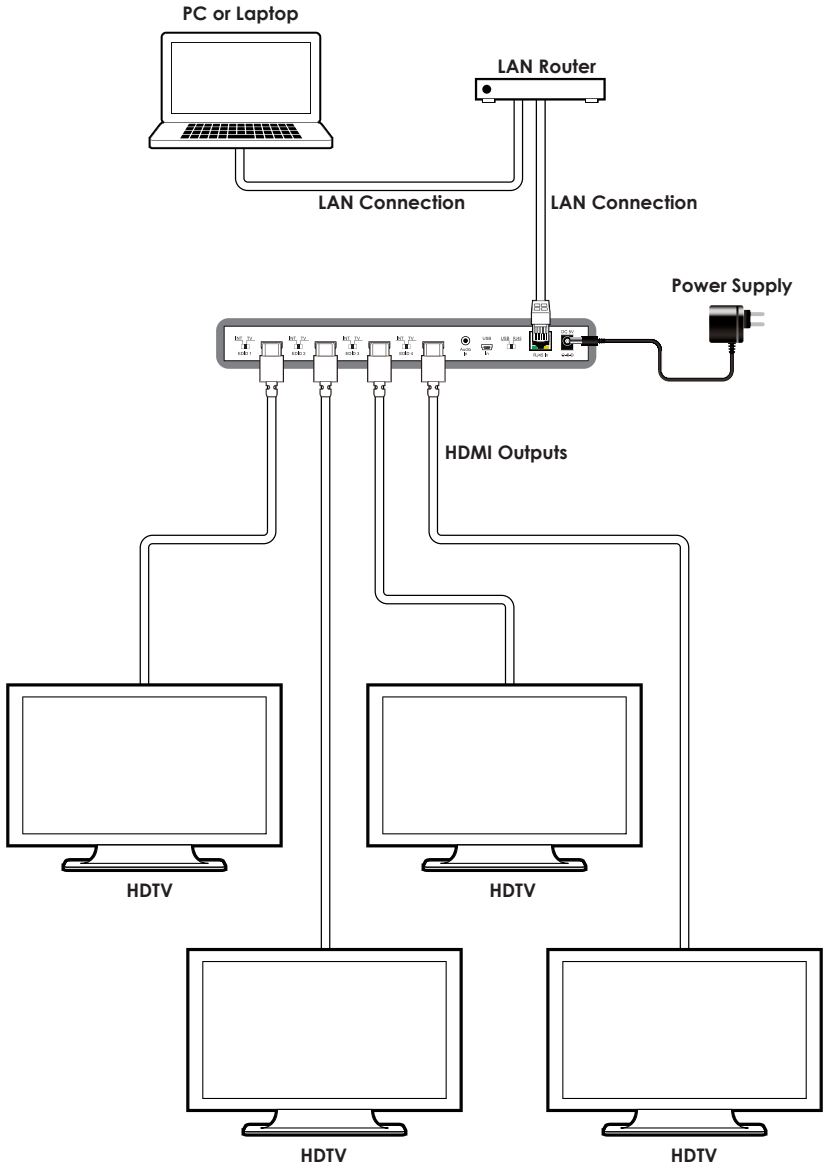

11. SPECIFICATIONS

Input Ports	1×USB, 1×RJ45, 1×3.5mm Mini-jack
Output Port	4×HDMI
Video Resolutions	Up to 1600×1200/1920×1080
Network Protocol	TCP/IP
Operating System	Windows XP SP2, Vista 32-bit & Windows 7
ESD Protection	Human body model: ±15kV (air-gap discharge) ±8kV (contact discharge)
Power Supply	5V/2.6A DC (US/EU standards, CE/FCC/UL certified)
Dimensions	270mm (W)×126mm (D)×30mm(H)
Weight	850g
Chassis Material	Metal
Color	Black
Operating Temperature	0 °C~40 °C / 32 °F ~ 104 °F
Storage temperature	-20 °C~60 °C / -4 °F ~ 140 °F
Relative Humidity	20~90 % RH (no condensation)
Power Consumption	9.5W (Max)

12. ACRONYMS

ACRONYM	COMPLETE TERM
CAT5e	Category 5 Cable
CAT6	Category 6 cable
EDID	Extended Display Identification Data
HDMI	High Definition Multimedia Interface
LAN	Local Area Network
USB	Universal Serial Bus



CYPRESS TECHNOLOGY CO., LTD

Home page: <http://www.cypress.com.tw>