



# CH-U331TR

UHD HDMI/DP to IP  
AV over IP Transceiver



Operation Manual



## DISCLAIMERS

The information in this manual has been carefully checked and is believed to be accurate. Cypress Technology assumes no responsibility for any infringements of patents or other rights of third parties which may result from its use.

Cypress Technology assumes no responsibility for any inaccuracies that may be contained in this document. Cypress also makes no commitment to update or to keep current the information contained in this document.

Cypress Technology reserves the right to make improvements to this document and/or product at any time and without notice.

## COPYRIGHT NOTICE

No part of this document may be reproduced, transmitted, transcribed, stored in a retrieval system, or any of its part translated into any language or computer file, in any form or by any means—electronic, mechanical, magnetic, optical, chemical, manual, or otherwise—without express written permission and consent from Cypress Technology.

© Copyright 2018 by Cypress Technology.

All Rights Reserved.

## TRADEMARK ACKNOWLEDGMENTS

All products or service names mentioned in this document are trademarks of the companies with which they are associated.

---



## SAFETY PRECAUTIONS

Please read all instructions before attempting to unpack, install or operate this equipment and before connecting the power supply. Please keep the following in mind as you unpack and install this equipment:

- Always follow basic safety precautions to reduce the risk of fire, electrical shock and injury to persons.
- To prevent fire or shock hazard, do not expose the unit to rain, moisture or install this product near water.
- Never spill liquid of any kind on or into this product.
- Never push an object of any kind into this product through any openings or empty slots in the unit, as you may damage parts inside the unit.
- Do not attach the power supply cabling to building surfaces.
- Use only the supplied power supply unit (PSU). Do not use the PSU if it is damaged.
- Do not allow anything to rest on the power cabling or allow any weight to be placed upon it or any person walk on it.
- To protect the unit from overheating, do not block any vents or openings in the unit housing that provide ventilation and allow for sufficient space for air to circulate around the unit.
- Please completely disconnect the power when the unit is not in use to avoid wasting electricity.

## VERSION HISTORY

REV.	DATE	SUMMARY OF CHANGE
RDV1	2019/11/27	Preliminary release



## CONTENTS

<b>1. Introduction</b> .....	<b>1</b>
<b>2. Applications</b> .....	<b>2</b>
<b>3. Package Contents</b> .....	<b>2</b>
<b>4. System Requirements</b> .....	<b>2</b>
<b>5. Features</b> .....	<b>3</b>
<b>6. Operation Controls And Functions</b> .....	<b>4</b>
6.1 Front Panel.....	4
6.2 Rear Panel.....	6
6.3 IR Cable Pinouts.....	8
6.4 RS-232 Pinout and Defaults .....	8
6.5 OSD Menu.....	9
6.6 WebGUI Control .....	12
6.6.1 System Tab.....	13
6.6.2 Video Wall Tab.....	16
6.6.3 Network Tab .....	20
6.6.4 Functions Tab .....	22
6.7 Telnet Control .....	27
6.8 Telnet Commands.....	28
<b>7. Connection Diagram</b> .....	<b>43</b>
<b>8. Specifications</b> .....	<b>44</b>
8.1 Technical Specifications .....	44
8.2 Video Specifications .....	46
8.3 Audio Specifications .....	48
8.3.1 Digital Audio .....	48
8.3.2 Analog Audio .....	49
8.3.3 AVoIP Audio Availability .....	50
8.4 Cable Specifications .....	51
<b>9. Acronyms</b> .....	<b>52</b>

---



## 1. INTRODUCTION

This UHD HDMI/DP to IP AV over IP Transceiver forms a part of a multi-function video and data extension system. Every Transceiver can be configured to function as either a transmitter or a receiver, enhancing the flexibility of any installation. Both HDMI and DisplayPort video inputs are provided with support for resolutions up to 4K (4K@30Hz 4:4:4 or 4K@60Hz 4:2:0) along with analog audio, USB 2.0, IR and serial data extension using the TCP/IP protocol over regular Gigabit Ethernet networks (Cat.5e/6/7 copper or single/multi-mode fiber). When using standard Ethernet cables, this transceiver supports the extension of AVoIP signals up to 100 meters and the extension distance can be further extended (up to 100m per segment) by using gigabit network switches. This allows the user to cascade the system without signal loss or introducing delay. Alternatively, when using the SFP port and fiber cable, a single segment can be up to 2km (maximum distance depends on the fiber module and fiber type used).

When the extension system's units are in multicast mode, a single AV signal can be sent to a large number of receivers within the same local network without the additional receivers increasing the bandwidth requirements. Additionally, that same multicast signal can be used to create large multi-display video walls with amazing simplicity. When combined with the optional IP Master Controller the functionality of the system expands exponentially. Its centralized web-based interface greatly simplifies control and management of large distributed video matrix or video wall systems adding to their flexibility in large home or commercial installations.

The included Detection trigger in/out terminal block allows trigger signaling from detection devices such as smoke/gas detectors or door buzzers to be extended to your home control system. Configuration information is provided via On Screen Display (OSD) and control is by front panel controls, WebGUI, RS-232, and Telnet.

## 2. APPLICATIONS

- HDMI, DisplayPort, USB, Audio, IR, and RS-232 extension
- Broadcasting a system over a standard Ethernet connection
- Multimedia display on a large number of displays via multicast
- Hotel or convention center display multi-monitor broadcast
- Long distance data and video transmission via cascading
- Distributed video matrix system
- Distributed video wall system

## 3. PACKAGE CONTENTS

- 1×UHD HDMI/DP to IP AV over IP Transceiver
- 1×IR Extender Cable
- 1×IR Blaster Cable
- 1×5V/4A DC Power Adapter
- 1×Operation Manual

## 4. SYSTEM REQUIREMENTS

- HDMI or DisplayPort source equipment such as media players, video game consoles, PCs or set-top boxes.
- HDMI receiving equipment such as an HDTV, monitor or audio amplifier.
- Analog audio receiving equipment such as headphones, audio amplifiers or powered speakers.
- A Gigabit Ethernet network switch with jumbo frame support is required. (8K jumbo frames are strongly recommended.)
- A Gigabit Ethernet switch with “IGMP snooping” enabled is required for multicast support.

## 5. FEATURES

- HDMI 2.0 and DVI 1.0 compatible
- HDCP 1.x & 2.2 compliant
- 1 HDMI input, 1 DisplayPort input
- 1 HDMI output (Functions as local monitor output in Transmitter mode)
- Video, audio, and control transmission over TCP/IP in Unicast (point-to-point) or Multicast (single-to-many) modes
- HDMI and DisplayPort inputs support resolutions up to 4K@60Hz (4:2:0, 8-bit) or 4K@30Hz (4:4:4, 8-bit)
- HDMI output resolutions up to 4K@30Hz (RGB, 8-bit)

*Note: 4K@50/60Hz (4:2:0) sources are automatically converted to 4K@25/30Hz (RGB) for output.*

- Supports extension of many audio formats including 8 channel LPCM and standard Bitstream
- Supports independent breakaway A/V matrix switching
- The analog Line In (in Transmitter Mode) is automatically embedded in the streaming output and can be freely routed to any receiver's Line Out port
- May be powered directly by PoE when connected to a Gigabit Ethernet switch that provides PoE (802.3at Type 2)
- Supports USB keyboard, mouse and storage extension
- Supports IR and RS-232 bypass
- Basic configuration via front panel buttons with an OSD, and can be fully controlled via WebGUI, RS-232, or Telnet
- Supports the use of an external control center (IP Master Controller) to provide expanded functionality (Contact your authorized dealer for more information)



## 6. OPERATION CONTROLS AND FUNCTIONS

### 6.1 Front Panel

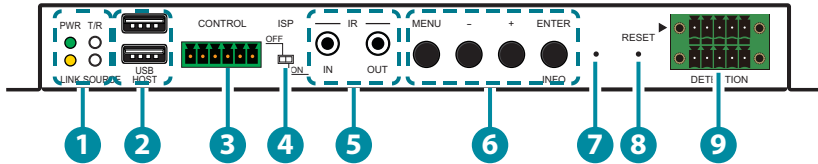

**1 PWR LED:** This LED will flash while the unit is powering on and will illuminate solidly once it is ready to be used.

**T/R LED:** This LED indicates if the unit is in Transmitter (green LED) or Receiver (red LED) Mode.

**LINK LED:** If the unit has no network connection the LINK LED will not illuminate.

- **Transmitter Mode:** While the transmitter is attempting to establish a connection with a receiver the LINK LED will flash. When the transmitter has established a stable connection with a receiver the LINK LED will illuminate solidly.

- **Receiver Mode:** While the receiver is attempting to establish a connection with a transmitter the LINK LED will flash. When the receiver has established a stable connection with a transmitter the LINK LED will illuminate solidly.

**SOURCE LED:** This LED will illuminate to indicate that a local video input is selected and live. Green indicates that the local HDMI input is live and red indicates that the local DisplayPort input is live.

*Note: When the unit is in Receiver Mode, and streaming is active, this LED will remain off.*

**2 USB HOST Ports:** When in Receiver Mode, connect directly to standard USB devices such as a mouse, keyboard or flash drive to extend their USB functionality to the currently active/routed transmitter.

*Note: These ports are not active in Transmitter Mode. When this unit is powered via PoE it is recommended to avoid using high power draw USB devices such as external hard drives.*

- 3 CONTROL 6-pin Terminal Block:** Connect directly to your PC/laptop to send commands to serial devices connected to routed transmitter/receivers. Serial mode can be switched between RS-232, RS-422, and RS-485 using the OSD menu.

*Note: When in Transmitter Mode, and set to multicast output, every connected receiver unit can extend serial commands through the transmitter and commands sent from the transmitter side will be sent through all associated receivers.*

- 4 ISP Switch:** This is for factory use only.

*Note: This switch should always be left in the “Off” position unless instructed to turn it on by technical support.*

- 5 IR IN Port:** Connect to the provided IR Extender to extend the IR control range of remotely located devices. Ensure that the remote being used is within direct line-of-sight of the IR Extender.

*Note: When in Transmitter Mode, and set to multicast output, the IR signal is sent to all associated receivers.*

**IR OUT Port:** Connect to the provided IR Blaster to transmit IR signals sent from the associated receiver to devices within direct line-of-sight of the IR Blaster

- 6 MENU Button:** Press to enter the OSD menu, or to back out from menu items.

**- (MINUS) Button:** Press to move up or adjust selections within OSD menus. When not in a menu, press to manually switch between inputs.

**+ (PLUS) Button:** Press to move down or adjust selections within OSD menus. When not in a menu, press to manually switch between inputs.

**ENTER/INFO Button:** When inside an OSD menu, press to confirm a selection or to go deeper into a menu item. When not in a menu, press to activate the Information OSD.

- 7 ISP Pinhole:** This is for factory use only.

- 8 RESET Pinhole:** Press this recessed button to reset the unit’s power supply and reboot the unit.

*Note: Settings will not be reset.*

- 9 DETECTION 10-pin Terminal Block:** This terminal block provides a way to bypass and monitor externally generated trigger states. Connect the 4 top pins to trigger monitoring devices, such as a security station or alarm system, to receive trigger states from a connected transmitter or receiver.

Connect the 4 bottom pins to devices with trigger activation functionality, such as window security alarms, smoke detectors, or door buzzers, to extend their current state to a connected transmitter/receiver.

*Note: This is designed to be connected to individual trigger devices and is NOT compatible with the Trigger Control Keypad.*

## 6.2 Rear Panel

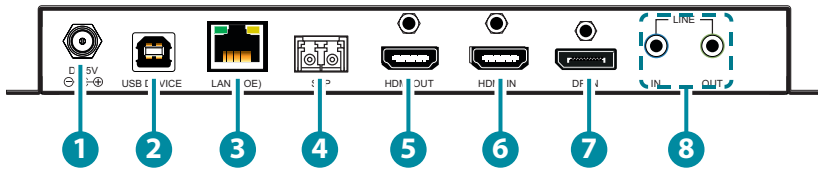

**1 DC 5V Port:** Plug the 5V DC power adapter into the unit and connect it to an AC wall outlet for power. (Optional, not needed if the unit is powered via PoE)

**2 USB DEVICE Port:** When in Transmitter Mode, connect directly to a PC to extend its USB functionality to the ports on the connected receiver.

*Note: This port is not active in Receiver Mode.*

**2 LAN (POE) Port:** Connect via a Gigabit Ethernet switch to compatible transmitter/receiver to transmit data, and to a PC/laptop to control the unit via WebGUI.

*Note: Only one network port, either the LAN or SFP, can be active at one time. This unit can be powered directly by the connected Gigabit Ethernet switch if it provides PoE (802.3at Type 2).*

**4 SFP Slot:** Insert a standard SFP module, and connect the appropriate optical cable to allow data transmission to a compatible receiver/transmitter or to a Gigabit Ethernet optical fiber network switch.

*Note: Only one network port, either the LAN or SFP, can be active at one time. The SFP module must support a dual-optical fiber connection style, such as LC, or be pre-terminated with dual-optical fiber cables. Single-mode and multi-mode support is dependent on the SFP modules used.*

**5 HDMI OUT Port:** Connect to an HDMI TV, monitor, or amplifier for digital video and audio output.

**6 HDMI IN Port:** Connect to HDMI source equipment such as a media player, game console, or set-top box.

- 7 DP IN Port:** Connect to DisplayPort source equipment such as a PC or laptop.
- 8 LINE IN Port:** Connect to the stereo analog output of a device such as a CD player or PC.

*Note: When a live audio source is connected to the Line In port, it will be automatically embedded into the transmitted signal, and will completely replace any existing HDMI audio when the unit is in “Auto” Audio over IP mode.*

**LINE OUT Port:** Connect to powered speakers or an amplifier for stereo analog audio output. Outputs stereo audio from the currently routed transmitter when in Receiver mode, or from the connected receiver when in Transmitter mode.

*Note: Transmitter Mode output is only available when the local Line In port also has a live audio source actively streaming and both units are in unicast mode. Supports LPCM 2.0 sources only.*

### 6.3 IR Cable Pinouts

IR Blaster Cable

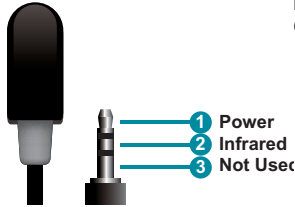

IR Extender Cable

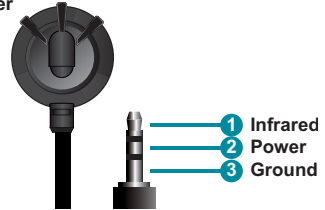

### 6.4 RS-232 Pinout and Defaults

Serial Port Default Settings	
Baud Rate	115200
Data Bits	8
Parity Bits	None
Stop Bits	1
Flow Control	None

Control Port (RS-232 mode)

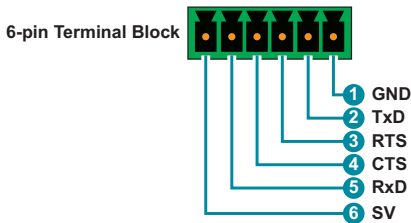

Control Port (RS-422 mode)

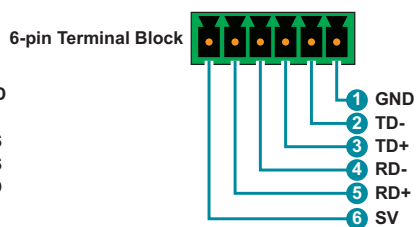

Control Port (RS-485 mode)

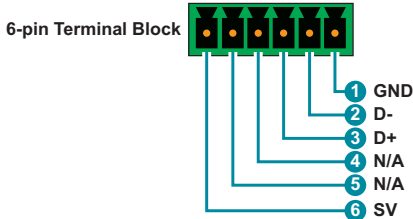

## 6.5 OSD Menu

Many functions of this unit can be controlled by using the OSD (On Screen Display) which is activated by pressing the MENU button on the front of the unit. Use the + (PLUS), - (MINUS), and ENTER buttons to navigate the OSD menu. Press the MENU button to back out from any menu item and then press it again to close the menu.

MAIN MENU
OSD
EDID
HDCP
<b>Device Setting</b>
<b>Information</b>

The individual functions of the OSD will be introduced in the following section. Items marked in BOLD are the factory default settings.

OSD	
2ND LEVEL	3RD LEVEL
Display Information	<b>ON</b>
	Off
Information Timeout	Off
	10~40 Sec [ <b>10 Sec</b> ]
Menu Timeout	Off
	10~40 Sec [ <b>10 Sec</b> ]

- 1) **Display Information:** Enable or disable the Information OSD.
- 2) **Information Timeout:** Set the display timeout for the Information OSD.
- 3) **Menu Timeout:** Set the display timeout for the OSD Menu.

EDID	
2ND LEVEL	3RD LEVEL
VoIP EDID	[Display current EDID data for each port]
DP In EDID	
HDMI In EDID	

- 1) **EDID:** Selecting any of the input ports will display the current EDID data being provided to that port.

HDCP	
2ND LEVEL	3RD LEVEL
HDMI HDCP	<b>FOLLOW OUT</b>
	Follow In
	Disable
DP HDCP	<b>FOLLOW OUT</b>
	Follow In
	Disable

- 1) **HDMI HDCP:** Set the HDCP behavior of the HDMI input.
- 2) **DP HDCP:** Set the HDCP behavior of the DisplayPort input.
  - **Follow Out:** The input supports up to the HDCP version supported by the connected display.
  - **Follow In:** The input supports up to the HDCP version required by the connected source.
  - **Disable:** HDCP support is completely disabled.

DEVICE SETTING	
2ND LEVEL	3RD LEVEL
Status	<b>TRANSMITTER</b>
	Receiver
Input	<b>HDMI IN</b>
	DP In
	VoIP <i>(Receiver mode only)</i>
Local Priority	<b>OFF</b>
	DP
	HDMI

- 1) **Status:** Set the operational mode of the transceiver. After changing the operation mode, the unit will automatically reboot.
- 2) **Input:** Select the preferred input source, HDMI, DisplayPort, or VoIP.  
*Note: VoIP is only available in Receiver mode.*
- 3) **Local Priority:** Enable the priority auto switch mode and select the input to prioritize or disable the mode completely. When enabled, the unit will automatically switch to the designated input if a live signal is present on it.

INFORMATION	
2ND LEVEL	3RD LEVEL
Resolution	[Show the current status of each item]
Status	
FW Version	
IP	
MAC	
VoIP Channel	

- 1) **Information:** Shows details of the unit's current status including detected input resolution, transceiver mode, firmware version, IP address, MAC address, and VoIP channel.



## 6.6 WebGUI Control

All major functions of the unit, including status, streaming method, streaming channel selection, output resolution, video wall configuration, EDID management, Ethernet settings, and reset/firmware functions are controllable via multiple tabs in the WebGUI interface allowing for reasonably intuitive operation.

Each transmitter, receiver, or transceiver is controlled by its own WebGUI interface which may be accessed by opening a standard web browser on a PC and typing in the IP address of the unit you wish to connect to. On a transceiver unit, the IP address of a unit can be obtained simply by checking the information screen within the OSD menu, accessed by pressing the menu button.

On stand-alone transmitters/receivers you can discover the IP address by checking the status OSD that is displayed when there is no live video source or no live link. Breaking the link is accomplished by pressing and holding the “LINK” button on the front of the unit for 3 seconds (The LINK light will blink rapidly, then turn off). Once the link is broken, each connected receiver will output a 640×480 black screen with OSD text at the bottom identifying its own IP address (Local IP), as well as the IP address of the transmitter (Remote IP) that shares the same broadcasting channel with it (channel 0 by default). After obtaining the IP address information, press and hold the “LINK” button again for 3 seconds to return the unit to normal operation (The LINK light will light up solid yellow).

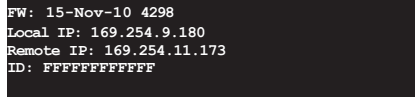

```
FW: 15-Nov-10 4298
Local IP: 169.254.9.180
Remote IP: 169.254.11.173
ID: FFFFFFFF
```

After connecting to a unit’s WebGUI, you will find a screen containing multiple tabs for each functionality area of the unit. The individual tabs and functions will be introduced in the following sections.

*Note: AVoIP streaming uses a large amount of bandwidth (especially at higher resolutions) and a Gigabit Ethernet network switch with jumbo frame support and IGMP snooping is required. A professional managed switch with VLAN support is strongly recommended. Please note that most consumer-grade routers are not able to handle the high traffic rates generated by multicast mode, so using a router directly as your network switch is discouraged. It is strongly suggested to avoid mixing your regular network traffic with AVoIP streaming traffic and the AVoIP traffic should exist within a separate subnet, at the minimum.*

## 6.6.1 System Tab

The System tab contains 4 windows that provide access to firmware version information, a firmware update interface, utilities for rebooting and resetting the unit, basic EDID management, Telnet command entry, and a variety of statistics and information about the operational state of the unit.

- 1) **Version Information Window:** This window displays detailed information about the current firmware version.

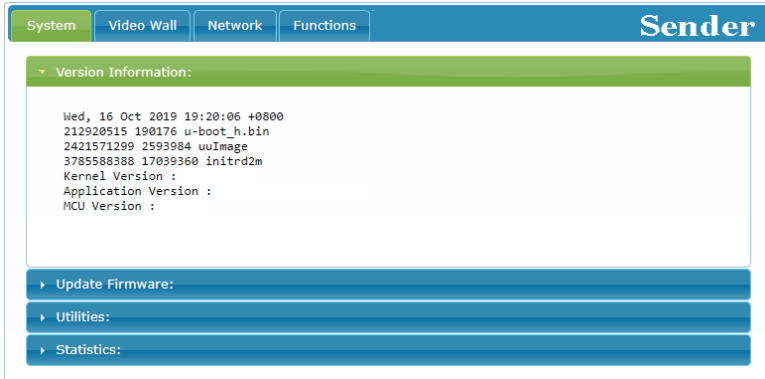

The screenshot shows the 'Sender' interface with the 'System' tab selected. The 'Version Information' window is expanded, displaying the following text:

```
Wed, 16 Oct 2019 19:20:06 +0800
212920515 190176 u-boot_h.bin
2421571299 2593984 uuImage
3785588388 17039360 initrd2m
Kernel Version :
Application Version :
MCU Version :
```

Below the version information, there are three expandable sections: 'Update Firmware:', 'Utilities:', and 'Statistics:'.

- 2) **Update Firmware Window:** Provides a way to update the Transmitter's firmware. Click "Choose File" to select the firmware update file from the local PC (\*.bin format). After selecting an appropriate file, click the "Upload" button to begin the update process.

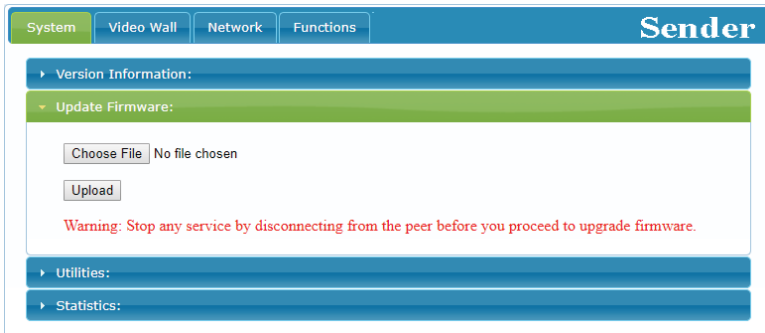

The screenshot shows the 'Sender' interface with the 'System' tab selected. The 'Update Firmware' window is expanded, displaying the following text:

No file chosen

**Warning: Stop any service by disconnecting from the peer before you proceed to upgrade firmware.**

Below the update interface, there are two expandable sections: 'Utilities:' and 'Statistics:'.

- 3) **Utilities Window:** The Utilities window allows users to reset the unit back to the factory defaults by clicking “Factory Default”. The unit may be rebooted (without resetting settings) by pressing the “Reboot” button.

If the EDID received from the primary receiver unit (selected via a checkbox on the preferred receiver in multicast mode) has compatibility issues with the connected HDMI source, the internal HDMI EDID (up to 4K30 w/audio) can be selected. Please press “Apply” after making the selection.

*Note: EDID selection is only available in Transmitter Mode. This EDID setting will be reset if the unit is rebooted.*

Finally, individual Telnet commands may be sent to the unit by using the “Console API Command” text entry field and pressing “Apply”. Any responses from the unit will be displayed in the “Output” field.

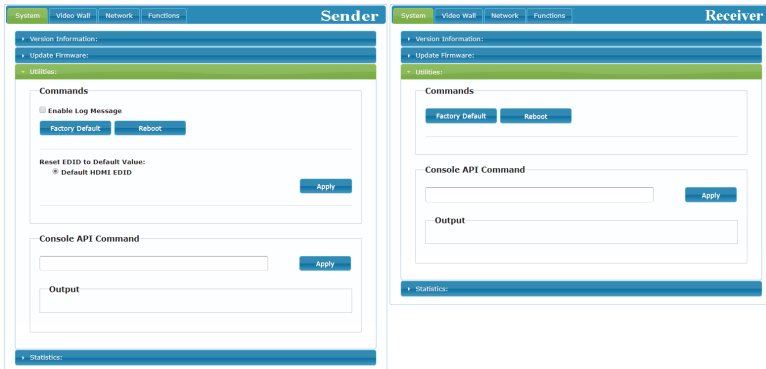

- 4) **Statistics Window:** The Statistics window shows all available information about the operational status of the unit, including current Host ID Name, SN, Ethernet information, MAC address, unicast/multicast mode, link status and mode.



The screenshot displays the 'Sender' web interface. At the top, there are navigation tabs: 'System' (highlighted in green), 'Video Wall', 'Network', and 'Functions'. The main header area is blue and contains the word 'Sender' in white. Below the header, there is a list of expandable sections: 'Version Information', 'Update Firmware', 'Utilities', and 'Statistics'. The 'Statistics' section is expanded, showing two sub-sections: 'State Machine' and 'Network'. The 'State Machine' section shows 'State: s\_srv\_on'. The 'Network' section displays the following information: ID (Host Name): 0, IP Address: 169.254.4.109, Subnet Mask: 255.255.0.0, Default Gateway: 169.254.0.254, MAC Address: (blank), Casting Mode: Multicast Mode, Link Status: on, Link Mode: 1G, and S/N: (blank).

## 6.6.2 VIDEO WALL TAB

The Video Wall tab allows user to design, edit and manipulate a video wall system created using multiple receiver units connected to identical displays. The bezel and video size of the displays being used, as well as the horizontal and vertical monitor count, is defined here. Video stretch and rotation can also be controlled on this tab. Receivers in the video wall's group (all receivers sharing the same channel) can be controlled by any other unit within the same group.

*Note: The Video Wall tab is accessible when the unit is in both Transmitter and Receiver Mode, however video wall settings only have an effect on transceivers in Receiver Mode, or normal receivers.*

When saving changes on the Video Wall tab, remember to select the appropriate "Apply To:" target unit before pressing the "Apply" button. To make changes to the unit you are currently connected to, select "This" as the target. Otherwise, select the IP address of the receiver (Client) you want to apply changes to from the "Apply To:" drop down.

*Note: While it is possible to create small video walls using unicast mode, in order to more efficiently use the available network bandwidth, it is strongly recommended to only use multicast mode when creating video walls.*

- 1) Bezel and Gap Compensation:** This section of the Video Wall tab is used to define the physical dimensions of each display being used in the video wall. Accurate measurements are needed of the monitor's outer frame (OW, OH) and the video screen (VW, VH). The measurements may be made using any unit format (inches, mm, cm, etc.) as long as ALL measurements in the same wall are made using the exact same units and the numbers are integers.

**Bezel and Gap Compensation**

OW:

OH:

VW:

VH:

Apply To: "All" device(s) in the list

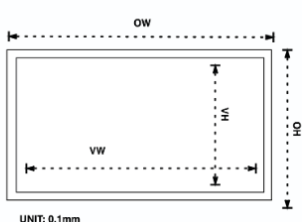

UNIT: 0.1mm

- **OW (Outer Width):** This is the horizontal measurement of the display's outer case.
- **OH (Outer Height):** This is the vertical measurement of the display's outer case.
- **VW (Video Width):** This is the horizontal measurement of the display's video screen.
- **VH (Video Height):** This is the vertical measurement of the display's video screen.

*Note: Typically all monitors in a video wall are identical and have the same dimensions, but it is possible to use differently sized displays as long as the same measurement units are used to measure each display and the displays are still arranged in a normal rectangular layout with corners meeting at the same place.*

- **Apply To:** Select which unit(s) to send updated settings to when "Apply" is pressed.
  - Selecting "All" will direct updates to the video wall Bezel settings of all units in the current video wall group (transmitter and receivers).
  - Selecting "This" will direct updates to the video wall settings of the unit whose WebGUI you are currently connected to.
  - Selecting an IP address from the "Clients" list will direct updates to the video wall settings of the receiver with that IP address.

**2) Wall Size and Position Layout:** This section of the Video Wall tab is used to define the number of displays used in the video wall as well as the location of the specific display within the video wall. A typical video

wall consists of an equal number of horizontal and vertical monitors (for example: 2×2 or 3×3), however it is possible to create video walls using this system with a wider variety of dimensions as long as the end result is still a rectangle (for example: 5×1 or 2×3). Both horizontal and vertical dimensions are limited to a maximum of 16 displays.

**Wall Size and Position Layout**

**Vertical Monitor Count:**

**Horizontal Monitor Count:**

**Row Position:**

**Column Position:**

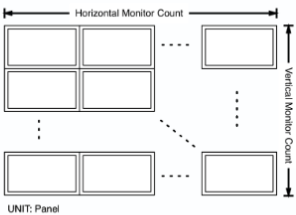

- **Vertical Monitor Count:** Define the number of displays in the video wall, measured vertically. (Maximum is 16 displays)
  - **Horizontal Monitor Count:** Define the number of displays in the video wall, measured horizontally. (Maximum is 16 displays)
  - **Row Position:** Set the vertical location of the currently controlled display. (Counts top to bottom, from 0 to 15)
  - **Column Position:** Set the horizontal location of the currently controlled display. (Counts left to right, from 0 to 15)
- 3) **Preferences:** This section of the Video Wall tab provides additional controls over how the source video is displayed on the video wall as well as providing a drop down to determine which receiver to apply changed settings to.

**Preferences**

**Stretch Type:**

**Clockwise Rotate:**

**Apply To:** "This" device connected by your browser

Apply

Show OSD

- **Stretch Type: Set the video stretch method.**
  - Selecting "Fit In" will expand the video to exactly fit the dimensions

of the video wall regardless of the source's original aspect ratio.

- Selecting "Stretch Out" will zoom the video until the video wall is filled in all 4 dimensions while maintaining the aspect ratio of the original source.
- **Clockwise Rotate:** Set the rotation of the video output to 0, 180 or 270 degrees.
- **Apply To:** Select which unit(s) to send updated settings to when "Apply" is pressed.
  - Selecting "This" will direct updates to the video wall settings of the unit whose WebGUI you are currently connected to.
  - Selecting an IP address from the "Clients" list will direct updates to the video wall settings of the receiver with that IP address.
- **Show OSD:** Enables or disables the OSD display of the current channel selection.

*Note: When setting up a new video wall, or changing the configuration of an existing one, remember to update the configuration of each receiver in the system.*



### 6.6.3 Network Tab

The Network tab provides control over the transceiver’s broadcast or reception channel, IP configuration, and network broadcast mode. Changes made to the network settings will require a reboot of the unit. After clicking on “Apply” please follow the reboot instructions in the WebGUI.

*Note: If the IP address is changed then the IP address required for WebGUI access will also change accordingly. If the new address is assigned via “Auto IP” or “DHCP” it will be necessary to obtain the newly assigned IP address by checking the information screen within the OSD menu, accessed by pressing the menu button.*

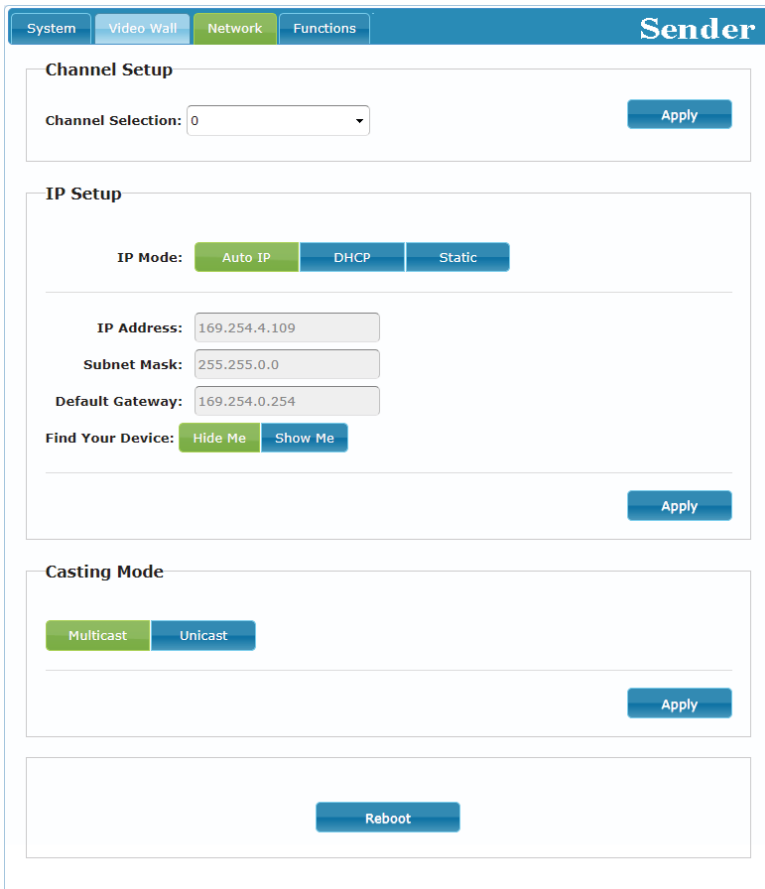

**System** | **Video Wall** | **Network** | **Functions** **Sender**

---

**Channel Setup**

Channel Selection:  **Apply**

---

**IP Setup**

IP Mode:

---

IP Address:

Subnet Mask:

Default Gateway:

Find Your Device:

**Apply**

---

**Casting Mode**

**Apply**

---

**Reboot**

- 1) **Channel Setup:** Use the dropdown to select the broadcast or reception channel for the transceiver. All receivers on the local network will receive video and data content from the transmitter that set to the same channel. The available channel range is from 0 to 255.

*Note: Every transmitter within the same local network MUST be assigned a different broadcast channel in order to avoid conflicts.*

- 2) **IP Setup:** This section allows for configuration of the IP acquisition mode and Ethernet settings of the unit. It also provides an easy way to find the physical unit when installed with many other similar units.

- **IP Mode & Settings:** The IP mode may be switched between “Auto IP”, “DHCP” or “Static IP”. When the unit is set to Auto IP mode it will automatically assign itself an APIPA address from the 169.254.xxx.xxx range. When the unit is set to DHCP mode it will attempt to automatically obtain an IP address from a DHCP server. When the IP mode is set to static IP, you can manually set the IP address, netmask and gateway address. Click the “Apply” button to save changes made to the IP Mode or Configuration.

*Note: The default network setting for this unit is “Auto IP”.*

- **Find Your Device:** Selecting “Show Me” will cause the unit to immediately begin flashing the LEDs on the front of the unit to make it easy to find. Selecting “Hide Me” returns the LEDs to their normal behavior. This setting is useful when troubleshooting an installation with a large number of units in a rack.

- 3) **Casting Mode:** Allows for the selection of the networking mode used by the transceiver. Click the “Apply” button to save changes made to the broadcasting mode.

*Note: Receivers must be set to the same mode as the transmitter in order to receive video and data content.*

- **Multicast:** This mode sends a single video stream that can be viewed simultaneously by multiple receivers without increasing bandwidth usage. This mode is ideal for video wall or matrixing scenarios. Multicast mode requires a network switch with IGMP snooping enabled.

*Note: The 3 port network switch built into the dedicated receiver units supports IGMP snooping and may be used to distribute a multicast stream.*

- **Unicast:** This mode uses a discrete video stream between the transmitter and every connected receiver and is ideal for simple, point-to-point, streaming setups. This mode uses considerably more bandwidth than Multicast mode when multiple receivers are being used, however it does not require a network switch that supports IGMP snooping.

### 6.6.4 Functions Tab

The Functions tab provides control over the transceiver’s AV source management, streaming bandwidth/quality settings, and scaling, as well as defining how USB and serial signals are handled. The available controls are different depending on if the unit is in Transmitter Mode or Receiver Mode. Changes made to these settings typically require a reboot of the unit. After clicking on “Apply” please follow the reboot instructions in the WebGUI, if necessary.

- 1) **Video over IP (Transmitter Mode):** This section allows control over the streaming bit rate and quality when in Transmitter Mode.

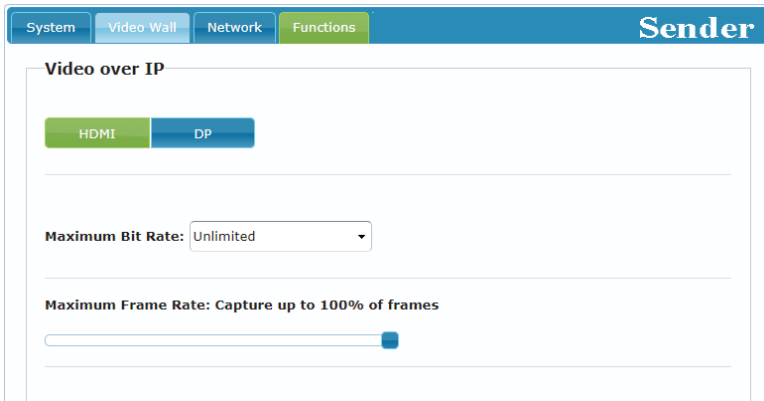

- **Source Selection:** Select the preferred input source, HDMI, or DisplayPort.
- **Maximum Bit Rate:** Set the maximum bit rate that can be used by the output video stream. Available options are: Unlimited, 400 Mbps, 200 Mbps, 100 Mbps, 50 Mbps. Selecting “Best Effort” will use up to the maximum available bandwidth in order to maintain a full framerate video stream.

*Note: While it is generally suggested to select “Unlimited” when streaming 4K video sources, the amount of bandwidth required can be very large and will limit the number of concurrent video streams.*

- **Maximum Framerate:** Adjusting this slider will set the percentage of frames from the source video to encode (2–100%). This is ideal for reducing the bandwidth requirements of high-resolution, but limited motion, sources such as slide presentations or information screens.

*Note: If the framerate is lowered too far with motion video sources, the video will become noticeably choppy.*

- 2) **Video over IP (Receiver Mode):** This section allows control over enabling/disabling the VoIP stream, the scaler/output resolution, and the behavior upon signal loss when in Receiver Mode.

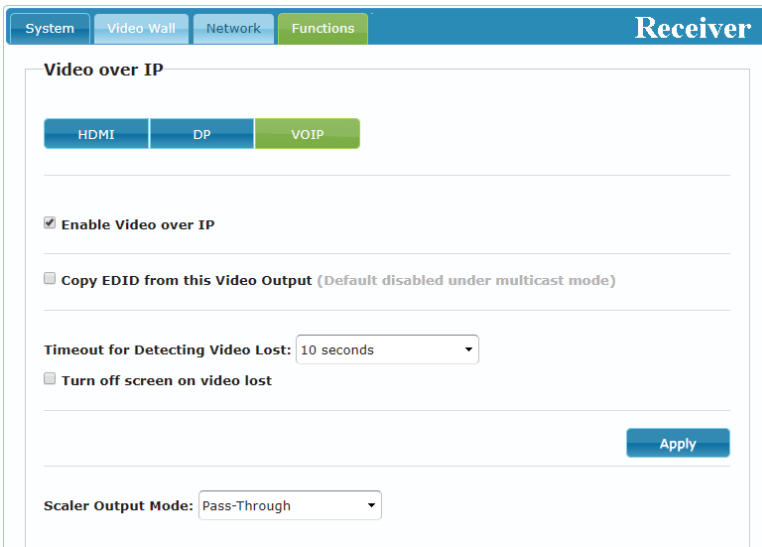

The screenshot shows the 'Receiver' configuration page with the 'Functions' tab selected. Under the 'Video over IP' section, there are three tabs: 'HDMI', 'DP', and 'VOIP'. The 'VOIP' tab is active. Below the tabs, there are several settings: a checked checkbox for 'Enable Video over IP', an unchecked checkbox for 'Copy EDID from this Video Output (Default disabled under multicast mode)', a dropdown menu for 'Timeout for Detecting Video Lost' set to '10 seconds', and an unchecked checkbox for 'Turn off screen on video lost'. An 'Apply' button is located at the bottom right of the settings area. Below the settings area, there is a 'Scaler Output Mode' dropdown menu set to 'Pass-Through'.

- **Source Selection:** Select the preferred input source, HDMI, DisplayPort, or VoIP(streaming).
- **Enable Video over IP:** Unchecking this checkbox will disable the VoIP stream completely. This option should always remain checked unless troubleshooting is being performed.
- **Copy EDID (Multicast Mode Only):** When multiple receivers are connected to a single transmitter in multicast mode, this check box selects which of the receivers should send its EDID to the transmitter for use with the source.

- **Video Loss Options:** Use the drop down to set the length of time to wait for a lost source to return before showing the “Link Lost” screen. Available options are: 3, 5, 10, 20, 30, 60 seconds, or Never Timeout. If the “Turn off screen” checkbox is checked, the HDMI output will be completely disabled, including sync, after the timeout time has passed.
  - **Scaler Output Mode:** Use the drop down list to select the preferred output resolution for the scaler. Selecting one of the specific resolutions will output all video at that resolution. Selecting “Pass-Through” will output the source video at its original resolution. Selecting “Native” will attempt to scale to the detected native resolution of the display connected to the HDMI output.
- 3) **Audio over IP (Transmitter Mode):** The audio source to embed in the outbound AVoIP stream is selected here. Selecting “Digital” will always embed the current digital video’s audio source (HDMI or DisplayPort), selecting “Analog” will always embed the Line In audio source, selecting Auto will embed audio according to the default routing behavior (see section 8.3.3).

**Audio over IP**

Auto
Digital
Analog

- 4) **USB over IP (Both Modes):** This section provides controls for the USB over IP extension functionality, including enabling/disabling USB support (Receiver mode only) and enabling various USB compatibility settings.

**USB over IP**

**Enable USB over IP**

---

**Operation Mode:**

- Auto select mode** (Recommended, choose per network casting mode)
- Active on link** (Unicast network's default mode)
- Active per request** (Multicast network's default mode)

---

**Compatibility Mode:**

**K/M over IP** (Uncheck when mouse/keyboard/touch panel not working as expected)

Apply

- **Enable USB over IP (Receiver Mode Only):** Unchecking this checkbox will completely disable support for USB streaming to this unit. This option should generally remain checked, but, if USB support is not required, disabling this feature can save some bandwidth.

- **Operation Mode:** Sets the USB extension mode. Available options are Auto, Active on link (Unicast optimized), and Active per request (Multicast optimized). Auto mode is set by default and will automatically select the correct mode depending on the broadcast mode of the unit.
- **Compatibility Mode:** These troubleshooting options enable specialized optimizations to solve issues when a mouse or touch panel is not responding properly. They should normally be left unchecked.

*Note: Some options are not available in Receiver mode.*

- 5) **Serial over IP (Both Modes):** This section provides controls for the serial over IP extension functionality, including enabling/disabling serial support and setting the RS-232 data configuration.

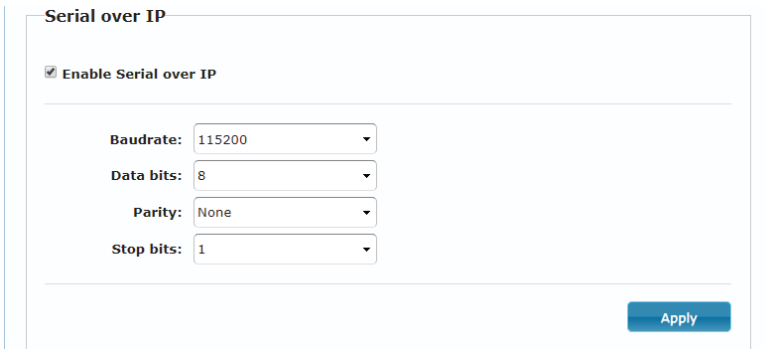

Serial over IP

Enable Serial over IP

Baudrate: 115200

Data bits: 8

Parity: None

Stop bits: 1

Apply

- **Enable Serial over IP (Receiver Mode Only):** Unchecking this checkbox will completely disable support for serial streaming to this unit. This option should generally remain checked, but, if serial support is not required, disabling this feature can save a very small amount of bandwidth.
- **Serial Settings:** Set the desired baud rate, data bits, parity, and stop bit for the RS-232 signal to extend.

*Note: The transmitter and receiver must have the same serial settings.*

- 6) **Trigger Status (Both Modes):** This section shows the current state of all input and output trigger pins on the unit. “L” will be displayed for pins that are currently “Low” and “H” will be displayed for pins that are currently “High”.

Trigger Status

Port	1	2	3	4
IN	L	L	L	L
OUT	L	L	L	L

Reboot

- 5) **Reboot (Both Modes):** Pressing this button will force the unit to reboot.

## 6.7 Telnet Control

Before attempting to use Telnet control, please ensure that both the unit and the PC are connected to the same active networks.

To Access the Command Line Interface (CLI)	
Windows 7	Click <b>Start</b> , type “cmd” in the search field, and press <b>Enter</b> .
Windows XP	Click <b>Start &gt; Run</b> , type “cmd”, and press <b>Enter</b> .
Mac OS X	Click <b>Go &gt; Applications &gt; Utilities &gt; Terminal</b> .

Once in the Command Line Interface (CLI) type “**telnet**” followed by the IP address of the unit (and the port number if it is non-standard) and then hit “**Enter**”. This will connect us to the unit we wish to control.

```
Microsoft Windows [Version 6.1.7601]
Copyright (c) 2009 Microsoft Corporation. All rights reserved.

C:\Users\Administrator>telnet 192.168.1.50 23
```

*Note 1: If the IP address is changed then the IP address required for Telnet access will also change accordingly.*

*Note 2: By default the unit is set to “Auto IP” mode. The current IP address can be obtained by using the unit’s OSD menu, or by checking the OSD info screen when there is no live video connection.*



## 6.8 Telnet Commands

COMMAND	
Description and Parameters	
<b>System Commands</b>	
<b>help</b> ↵	Show the full command list.
<b>help N1</b> ↵	Show help details about the specified command. <b>N1</b> = {Command name}
<b>get_hardware_version</b> ↵	Show the current hardware version.
<b>get_firmware_version</b> ↵	Show the current firmware version.
<b>set_device_name N1</b> ↵	Set the name of the unit. <b>N1</b> = {Name} [29 characters max, ASCII only]
<b>get_device_name</b> ↵	Show the current device name
<b>factory_reset N1</b> ↵	Perform a factory reset on the unit and select the IP mode after the reset completes. Available values for <b>N1</b> : 0 [Reset into Static IP mode] 1 [Reset into Auto IP mode]
<b>reboot</b> ↵	Reboot the unit.

**COMMAND****Description and Parameters****Network Configuration****get\_ipconfig**↵

Show the current IP configuration.

**set\_ip\_mode N1**↵

Set the IP configuration mode.

Available values for **N1**:

0	[Static IP mode]
1	[DHCP mode]
2	[Auto IP mode]

**get\_ip\_mode**↵

Show the current IP configuration mode.

**set\_ip\_address N1**↵

Set the static IP address.

**N1** = X.X.X.X [X = 0~255, IP address]

**get\_ip\_address**↵

Show the current IP address.

**set\_netmask N1**↵

Set the Ethernet netmask.

**N1** = X.X.X.X [X = 0~255, Netmask]

**get\_netmask**↵

Show the current Ethernet netmask.

**set\_gateway N1**↵

Set the IP gateway address.

**N1** = X.X.X.X [X = 0~255, Gateway address]

**get\_gateway**↵

Show the current gateway address.

COMMAND					
Description and Parameters					
<b>set_net_mode N1</b> ↵	<p>Set the network broadcast mode.</p> <p>Available values for <b>N1</b>:</p> <table> <tr> <td>0</td> <td>[Unicast mode]</td> </tr> <tr> <td>1</td> <td>[Multicast mode]</td> </tr> </table>	0	[Unicast mode]	1	[Multicast mode]
0	[Unicast mode]				
1	[Multicast mode]				
<b>get_net_mode</b> ↵	<p>Show the current network broadcast mode.</p>				
<b>set_jumbo_mtu N1</b> ↵	<p>Enable/disable the jumbo frame MTU.</p> <p>Available values for <b>N1</b>:</p> <table> <tr> <td>0</td> <td>[Disabled]</td> </tr> <tr> <td>1</td> <td>[Enabled]</td> </tr> </table>	0	[Disabled]	1	[Enabled]
0	[Disabled]				
1	[Enabled]				
<b>get_jumbo_mtu</b> ↵	<p>Show the jumbo frame MTU state.</p>				
Transceiver Commands					
<b>set_transceiver_device_mode N1</b> ↵	<p>Set the unit's transceiver device mode to Transmitter Mode or Receiver Mode.</p> <p>Available values for <b>N1</b>:</p> <table> <tr> <td>1</td> <td>[Receiver mode]</td> </tr> <tr> <td>2</td> <td>[Transmitter mode]</td> </tr> </table>	1	[Receiver mode]	2	[Transmitter mode]
1	[Receiver mode]				
2	[Transmitter mode]				
<b>get_transceiver_device_mode</b> ↵	<p>Show the unit's current transceiver device mode.</p>				
<b>video_source_hdmi</b> ↵	<p>Select HDMI as the video input source.</p>				
<b>video_source_dp</b> ↵	<p>Select DisplayPort as the video input source.</p>				

## COMMAND

### Description and Parameters

#### **video\_source\_voip**↵

Select the current streaming channel as the video input source.

*Note: Receiver mode only.*

#### **a N1**↵

Set the transmitter's local audio streaming source.

Available values for **N1**:

D	[Digital audio source]
A	[Analog audio source]
AUTO	[Automatic audio selection]

### Discovery Service Commands

#### **set\_showme N1**↵

Enable or disable Hello Mode. Hello Mode will cause the unit's LEDs to blink and visually identify the unit.

Available values for **N1**:

ON	[Enabled]
OFF	[Disabled]

#### **get\_showme**↵

Show the current Hello Mode state.

### Transmitter Mode Commands

#### **set\_tx\_channel N1**↵

Set the AVoIP transmission channel.

**N1** = 0~255 [Transmission channel]

#### **get\_tx\_channel**↵

Show the current AVoIP transmission channel.

#### **set\_quality N1**↵

Set the picture quality mode.

Available values for **N1**:

0	[Graphic mode]
1	[Video mode]

COMMAND											
Description and Parameters											
<b>get_quality</b> ↵	Show the current picture quality mode.										
<b>set_hdcp_allow N1</b> ↵	<p>Enable/disable HDCP encrypted source support.</p> <p>Available values for <b>N1</b>:</p> <table> <tr> <td>0</td> <td>[Disabled]</td> </tr> <tr> <td>1</td> <td>[Enabled]</td> </tr> </table>	0	[Disabled]	1	[Enabled]						
0	[Disabled]										
1	[Enabled]										
<b>get_hdcp</b>	Show the current HDCP support state.										
<b>set_bandwidth N1</b> ↵	<p>Set the broadcast stream bandwidth maximum.</p> <p>Available values for <b>N1</b>:</p> <table> <tr> <td>0</td> <td>[50 Mbps]</td> </tr> <tr> <td>1</td> <td>[100 Mbps]</td> </tr> <tr> <td>2</td> <td>[200 Mbps]</td> </tr> <tr> <td>3</td> <td>[400 Mbps]</td> </tr> <tr> <td>4</td> <td>[Unlimited]</td> </tr> </table>	0	[50 Mbps]	1	[100 Mbps]	2	[200 Mbps]	3	[400 Mbps]	4	[Unlimited]
0	[50 Mbps]										
1	[100 Mbps]										
2	[200 Mbps]										
3	[400 Mbps]										
4	[Unlimited]										
<b>set_frame_rate N1</b> ↵	<p>Set the percentage of frames from the source video to encode.</p> <p>Available values for <b>N1</b>:</p> <table> <tr> <td>0</td> <td>[Disable frame rate reduction]</td> </tr> <tr> <td>2~100</td> <td>[Percentage of frame rate]</td> </tr> </table>	0	[Disable frame rate reduction]	2~100	[Percentage of frame rate]						
0	[Disable frame rate reduction]										
2~100	[Percentage of frame rate]										
<b>set_vw_osd N1 {N2}</b> ↵	<p>Enable/disable the video wall OSD to display the receiver's ID number on the specified receiver's display.</p> <p>Available values for <b>N1</b>:</p> <table> <tr> <td>0</td> <td>[Disable OSD]</td> </tr> <tr> <td>1</td> <td>[Enable OSD]</td> </tr> </table> <p><b>N2</b> = 0~255 [Target receiver ID {Optional}]</p> <p><i>Note: Omitting <b>N2</b> makes the setting global to all receivers.</i></p>	0	[Disable OSD]	1	[Enable OSD]						
0	[Disable OSD]										
1	[Enable OSD]										

## COMMAND

### Description and Parameters

#### set\_vw\_layout N1 N2 {N3}↵

Set the video wall total horizontal and vertical display count for the specified receiver.

**N1** = 1~16 [Horizontal display count]

**N2** = 1~16 [Vertical display count]

**N3** = 0~255 [Target receiver ID {Optional}]

*Note: The target receiver ID number can be obtained by turning on the Video Wall OSD. Omitting **N3** makes the settings global to all receivers.*

#### set\_vw\_pos N1 N2 {N3}↵

Set the display's position within the video wall. (Cannot exceed the video wall's horizontal and vertical display count.)

**N1** = 0~15 [Row]

**N2** = 0~15 [Column]

**N3** = 0~255 [Target receiver ID {Optional}]

*Note: The target receiver ID number can be obtained by turning on the Video Wall OSD. Omitting **N3** makes the settings global to all receivers.*

#### set\_vw\_bc N1 N2 N3 N4 {N5}↵

Set the video wall display bezel compensation values for the specified receiver.

**N1** = 0~99999 [Video width]

**N2** = 0~99999 [Total display width]

**N3** = 0~99999 [Video height]

**N4** = 0~99999 [Total display height]

**N5** = 0~255 [Target receiver ID {Optional}]

*Note: The target receiver ID number can be obtained by turning on the Video Wall OSD. Omitting **N5** makes the settings global to all receivers.*

## COMMAND

### Description and Parameters

#### **set\_vw\_hscale N1 {N2}**

Set the video wall display horizontal zoom amount for the specified receiver.

**N1** = 0~99999 [Zoom amount in 1 pixel units]

**N2** = 0~255 [Target receiver ID {Optional}]

*Note: The target receiver ID number can be obtained by turning on the Video Wall OSD. Omitting **N2** makes the setting global to all receivers.*

#### **set\_vw\_vscale N1 {N2}**

Set the video wall display vertical zoom amount for the specified receiver.

**N1** = 0~99999 [Zoom amount in 1 pixel units]

**N2** = 0~255 [Target receiver ID {Optional}]

*Note: The target receiver ID number can be obtained by turning on the Video Wall OSD. Omitting **N2** makes the setting global to all receivers.*

#### **set\_vw\_shift N1 N2 {N3}**

Set the video wall display output shift for the specified receiver.

Available values for **N1**:

U [Shift up]

D [Shift down]

L [Shift left]

R [Shift right]

**N2** = 0~80000 [Pixel shift amount in increments of 8.]

**N3** = 0~255 [Target receiver ID {Optional}]

*Note: The target receiver ID number can be obtained by turning on the Video Wall OSD. Omitting **N3** makes the setting global to all receivers.*

**COMMAND****Description and Parameters****set\_vw\_delay N1 {N2}↵**

Set the video wall display delay compensation value for the specified receiver.

**N1** = 0~99999 [Delay in microseconds]

**N2** = 0~255 [Target receiver ID {Optional}]

*Note: The target receiver ID number can be obtained by turning on the Video Wall OSD. Omitting **N2** makes the setting global to all receivers.*

**set\_usb\_mouse N1↵**

Enable/disable USB mouse compatibility support.

Available values for **N1**:

0 [High resolution mode]

1 [Compatibility mode]

**get\_usb\_mouse↵**

Show the current USB mouse compatibility support state.

**Receiver Mode Commands****set\_edid\_copy N1↵**

Copy and use the EDID of the connected display.

Available values of **N1**:

0 [Disabled]

1 [Enabled]

**get\_edid\_copy↵**

Show the state of the EDID copy function.



## COMMAND

### Description and Parameters

#### **set\_rx\_channel N1 {N2}**↵

Select a content type from the specified AVoIP transmission channel to receive for output or select all content from that channel.

**N1** = 0~255 [Transmission channel]

Available values for **N2**:

V	[Video content]
A	[Audio content]
U	[USB content]
S	[Serial data content]
I	[IR content]

*Note: If **N2** is omitted, all content types will be received.*

#### **get\_rx\_channel N1**↵

Show the currently selected AVoIP transmission channel for the specified content type.

Available values for **N1**:

V	[Video content]
A	[Audio content]
U	[USB content]
S	[Serial data content]
I	[IR content]

## COMMAND

### Description and Parameters

#### set\_output\_res N1 ←

Set the output resolution.

Available values for **N1**:

0	[640×480@60Hz]
2	[800×600@60Hz]
4	[1024×768@60Hz]
6	[1280×768@60Hz]
7	[1280×800@60Hz]
8	[1280×1024@60Hz]
10	[1360×768@60Hz]
11	[1366×768@60Hz]
12	[1440×900@60Hz]
14	[1400×1050@60Hz]
15	[1600×900@60Hz]
16	[1600×1200@60Hz]
17	[1680×1050@60Hz]
20	[1920×1200@60Hz]
22	[Bypass]
23	[Native]
24	[480i@60Hz]
25	[576i@50Hz]
26	[480p@60Hz]
28	[576p@50Hz]
29	[720p@60Hz]
31	[720p@50Hz]
32	[720p@30Hz]
34	[720p@25Hz]
35	[1080i@60Hz]
37	[1080i@50Hz]
38	[1080p@60Hz]
40	[1080p@50Hz]
41	[1080p@30Hz]
43	[1080p@25Hz]
44	[1080p@24Hz]

*Note: Downscaling is limited to 1/2 of the horizontal/vertical pixels of the source. For example: 3840×2160 (4K) to 1920×1080 (1080p) is OK, but 3840×2160 (4K) to 1280×720 (720p) or 640×480 is not. When outputting to a video wall, the resolution of the entire video wall together (rather than each individual display) should be used for this calculation.*

COMMAND					
Description and Parameters					
<b>set_vw_osd N1</b> ↵	<p>Enable/disable the video wall OSD to display the receiver ID number on the connected display.</p> <p>Available values for <b>N1</b>:</p> <table> <tr> <td>0</td> <td>[Disable OSD]</td> </tr> <tr> <td>1</td> <td>[Enable OSD]</td> </tr> </table>	0	[Disable OSD]	1	[Enable OSD]
0	[Disable OSD]				
1	[Enable OSD]				
<b>get_vw_osd</b> ↵	Show the current video wall OSD state.				
<b>set_vw_layout N1 N2</b> ↵	<p>Set the video wall's total horizontal and vertical display count.</p> <table> <tr> <td><b>N1</b> = 1~16</td> <td>[Horizontal display count]</td> </tr> <tr> <td><b>N2</b> = 1~16</td> <td>[Vertical display count]</td> </tr> </table>	<b>N1</b> = 1~16	[Horizontal display count]	<b>N2</b> = 1~16	[Vertical display count]
<b>N1</b> = 1~16	[Horizontal display count]				
<b>N2</b> = 1~16	[Vertical display count]				
<b>get_vw_layout</b> ↵	Show the video wall's current total horizontal and vertical display count.				
<b>set_vw_pos N1 N2</b> ↵	<p>Set the position, within the video wall, of the display connected to this unit.</p> <table> <tr> <td><b>N1</b> = 0~15</td> <td>[Row]</td> </tr> <tr> <td><b>N2</b> = 0~15</td> <td>[Column]</td> </tr> </table> <p><i>Note: Cannot exceed the defined video wall's horizontal and vertical display count.</i></p>	<b>N1</b> = 0~15	[Row]	<b>N2</b> = 0~15	[Column]
<b>N1</b> = 0~15	[Row]				
<b>N2</b> = 0~15	[Column]				
<b>get_vw_pos</b> ↵	Show the current position within the video wall of the display connected to this unit.				

COMMAND	
Description and Parameters	
<b>set_vw_bc N1 N2 N3 N4↵</b>	
Set the video wall bezel compensation values for the display connected to this unit.	
<b>N1</b> = 0~99999	[Video width]
<b>N2</b> = 0~99999	[Total display width]
<b>N3</b> = 0~99999	[Video height]
<b>N4</b> = 0~99999	[Total display height]
<b>get_vw_bc↵</b>	
Show the current video wall bezel compensation values for the display connected to this unit.	
<b>set_vw_hscale N1↵</b>	
Set the horizontal zoom amount of the display connected to this unit.	
<b>N1</b> = 0~99999	[Zoom amount in 1 pixel units]
<b>get_vw_hscale↵</b>	
Show the current horizontal zoom amount of the display connected to this unit.	
<b>set_vw_vscale N1↵</b>	
Set the vertical zoom amount of the display connected to this unit.	
<b>N1</b> = 0~99999	[Zoom amount in 1 pixel units]
<b>get_vw_vscale↵</b>	
Show the current vertical zoom amount of the display connected to this unit.	
<b>set_vw_shift N1 N2↵</b>	
Set the video output shift of the display connected to this unit.	
Available values for <b>N1</b> :	
U	[Shift up]
D	[Shift down]
L	[Shift left]
R	[Shift right]
<b>N2</b> = 0~80000	[Pixel shift amount in increments of 8]

COMMAND	
Description and Parameters	
<b>get_vw_shift</b> ↵	Show the current video output shift of the display connected to this unit.
<b>set_vw_delay N1</b> ↵	Set the video wall display delay compensation value for this unit. <b>N1</b> = 0~99999 [Delay in microseconds]
<b>get_vw_delay</b> ↵	Show the current video wall display delay compensation value for this unit.
<b>set_serial_allow N1</b> ↵	Enable/disable serial bypass support. Available values for <b>N1</b> : 0 [Disabled] 1 [Enabled]
<b>get_serial_allow</b> ↵	Show the current serial bypass support state.
<b>set_usb_allow N1</b> ↵	Enable/disable USB support. Available values for <b>N1</b> : 0 [Disabled] 1 [Enabled]
<b>get_usb_allow</b> ↵	Show the current USB support state.
<b>request_usb</b> ↵	Explicitly requests USB control from the currently connected transmitter when the “Active per request” USB mode is active.

**COMMAND****Description and Parameters****Serial Commands****set\_serial\_baud N1**↵

Set the serial baud rate.

Available values for **N1**:

0	[300 baud]
1	[600 baud]
2	[1200 baud]
3	[2400 baud]
4	[4800 baud]
5	[9600 baud]
6	[19200 baud]
7	[38400 baud]
8	[57600 baud]
9	[115200 baud]

**get\_serial\_baud**↵

Show the current serial baud rate.

**set\_serial\_bits N1**↵

Set the number of serial data bits.

Available values for **N1**:

0	[5 bits]
1	[6 bits]
2	[7 bits]
3	[8 bits]

**get\_serial\_bits**↵

Show the current number of serial data bits.

**set\_serial\_parity N1**↵

Set the serial parity bit.

Available values for **N1**:

0	[None]
1	[Odd]
2	[Even]

**get\_serial\_parity**↵

Show the current serial parity bit.

COMMAND	
Description and Parameters	
<b>set_serial_stop N1</b> ↵	
Set the serial stop bits.	
Available values for <b>N1</b> :	
0	[1 bit]
1	[2 bits]
<b>get_serial_stop</b> ↵	
Show the current serial stop bits.	

*Note: Commands will not be executed unless followed by a carriage return. Commands are not case-sensitive.*

## 7. CONNECTION DIAGRAM

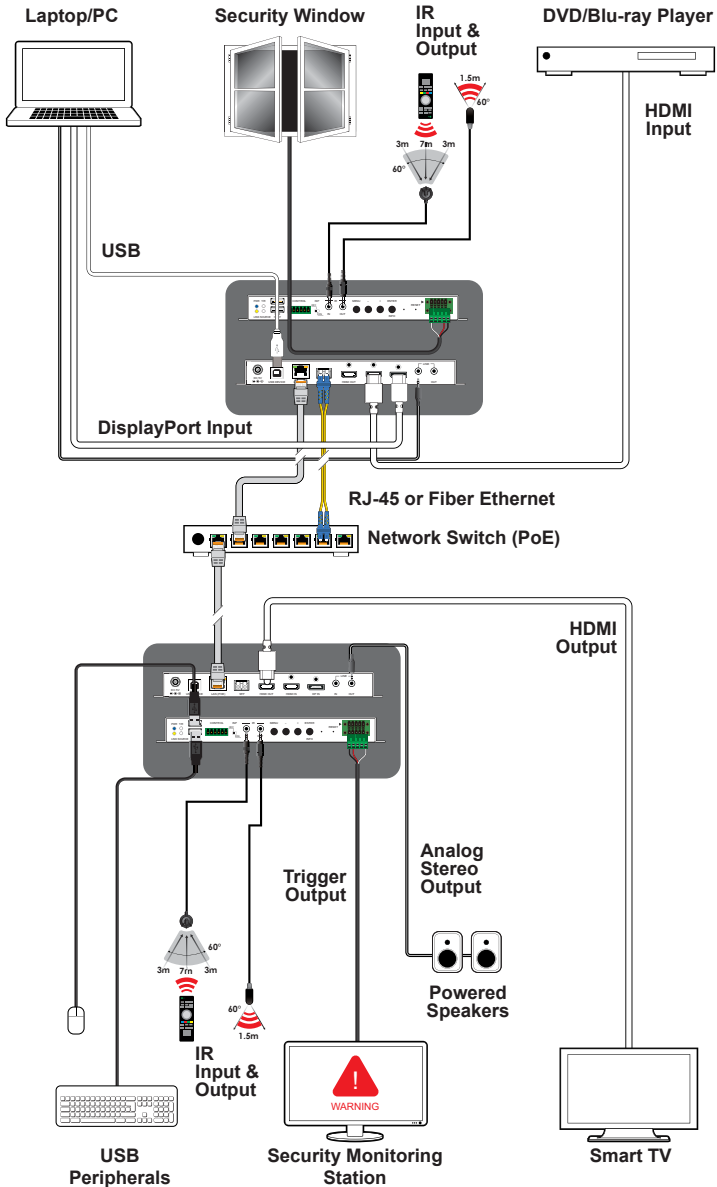



## 8. SPECIFICATIONS

### 8.1 Technical Specifications

<b>HDMI Bandwidth</b>	10.2Gbps
<b>DisplayPort Bandwidth</b>	10.2Gbps
<b>Ethernet Bandwidth</b>	1Gbps
<b>Input Ports</b>	1×HDMI (Type-A) 1×DisplayPort 1×Stereo Audio (3.5mm)
<b>Output Ports</b>	1×HDMI (Type-A) 1×Stereo Audio (3.5mm)
<b>Pass-through Ports</b>	1×IR Extender (3.5mm) 1×IR Blaster (3.5mm) 2×USB 2.0 (Type-A) 1×USB 2.0 (Type-B) 8×Trigger (10-pin Terminal Block)
<b>Pass-through/Control Port</b>	1×Serial (6-pin Terminal Block)
<b>Bi-directional/Control Ports</b>	1×LAN (RJ-45) 1×Fiber LAN (SFP Slot)
<b>IR Frequency</b>	30 – 50kHz (30 – 60kHz under ideal conditions)
<b>Baud Rate</b>	Up to 115200
<b>Power Supply (Optional)</b>	5V/4A DC (US/EU standards, CE/FCC/UL certified)
<b>PoE Support</b>	802.3at Type 2
<b>ESD Protection (HBM)</b>	±8kV (Air Discharge) ±4kV (Contact Discharge)
<b>Dimensions (W×H×D)</b>	231.5mm×25mm×158mm [Case Only] 231.5mm×25mm×167mm [All Inclusive]
<b>Weight</b>	929g
<b>Chassis Material</b>	Metal (Steel)



<b>Chassis Color</b>	Black
<b>Operating Temperature</b>	0°C – 40°C/32°F – 104°F
<b>Storage Temperature</b>	-20°C – 60°C/-4°F – 140°F
<b>Relative Humidity</b>	20 – 90% RH (Non-condensing)
<b>Power Consumption</b>	18.92W

## 8.2 Video Specifications

Supported Resolutions (Hz)	Input		Output	AVoIP
	HDMI	DP	HDMI	GbE
720×400p@70/85	✓	✓	✓	✓
640×480p@60/72/75/85	✓	✓	✓	✓
720×480i@60	✓	✓	✓	✓
720×480p@60	✓	✓	✓	✓
720×576i@50	✓	✓	✓	✓
720×576p@50	✓	✓	✓	✓
800×600p@56/60/72/75/85	✓	✓	✓	✓
848×480p@60	✓	✓	✓	✓
1024×768p@60/70/75/85	✓	✓	✓	✓
1152×864p@75	✓	✓	✓	✓
1280×720p@50/60	✓	✓	✓	✓
1280×768p@60/75/85	✓	✓	✓	✓
1280×800p@60/75/85	✓	✓	✓	✓
1280×960p@60/85	✓	✓	✓	✓
1280×1024p@60/75/85	✓	✓	✓	✓
1360×768p@60	✓	✓	✓	✓
1366×768p@60	✓	✓	✓	✓
1400×1050p@60	✓	✓	✓	✓
1440×900p@60/75	✓	✓	✓	✓
1600×900p@60RB	✓	✓	✓	✓
1600×1200p@60	✓	✓	✓	✓
1680×1050p@60	✓	✓	✓	✓
1920×1080i@50/60	✓	✓	✓	✓
1920×1080p@24/25/30	✓	✓	✓	✓
1920×1080p@50/60	✓	✓	✓	✓
1920×1200p@60RB	✓	✓	✓	✓

Supported Resolutions (Hz)	Input		Output	AVoIP
	HDMI	DP	HDMI	GbE
2560×1440p@60RB	x	x	x	x
2560×1600p@60RB	x	x	x	x
2048×1080p@24/25/30	x	x	x	x
2048×1080p@50/60	x	x	x	x
3840×2160p@24/25/30	✓	✓	✓	✓
3840×2160p@50/60 (4:2:0)	✓	✓	x	x
3840×2160p@24, HDR10	x	x	x	x
3840×2160p@50/60 (4:2:0),HDR10	x	x	x	x
3840×2160p@50/60	x	x	x	x
4096×2160p@24/25/30	✓	✓	✓	✓
4096×2160p@50/60 (4:2:0)	✓	✓	x	x
4096×2160p@24, HDR10	x	x	x	x
4096×2160p@50/60 (4:2:0),HDR10	x	x	x	x
4096×2160p@50/60	x	x	x	x

*Note: 4K@50/60Hz (4:2:0) video sources will automatically be converted to 4K@25/30Hz (RGB) for AVoIP transmission.*

## 8.3 Audio Specifications

### 8.3.1 Digital Audio

HDMI Input / Output	
LPCM	
Max Channels	8 Channels
Sampling Rate (kHz)	32, 44.1, 48, 88.2, 96, 176.4, 192
Bitstream	
Supported Formats	Standard

DisplayPort Input	
LPCM	
Max Channels	8 Channels
Sampling Rate (kHz)	32, 44.1, 48, 88.2, 96, 176.4, 192
Bitstream	
Supported Formats	Standard

AVoIP Transmission	
LPCM	
Max Channels	8 Channels
Sampling Rate (kHz)	32, 44.1, 48, 88.2, 96, 176.4, 192
Bitstream	
Supported Formats	Standard

### 8.3.2 Analog Audio

Analog Input	
Max Audio Level	2Vrms
Impedance	10k $\Omega$
Type	Unbalanced

Analog Output	
Max Audio Level	2Vrms
THD+N	< -66dB@0dBFS 1kHz (A-wt)
SNR	> 80dB@0dBFS
Frequency Response	< $\pm$ 25dB@20Hz~20kHz
Crosstalk	< -60dB@10kHz
Impedance	1k $\Omega$
Type	Unbalanced

### 8.3.3 AVoIP Audio Availability

#### Unicast Data Transmission Mode

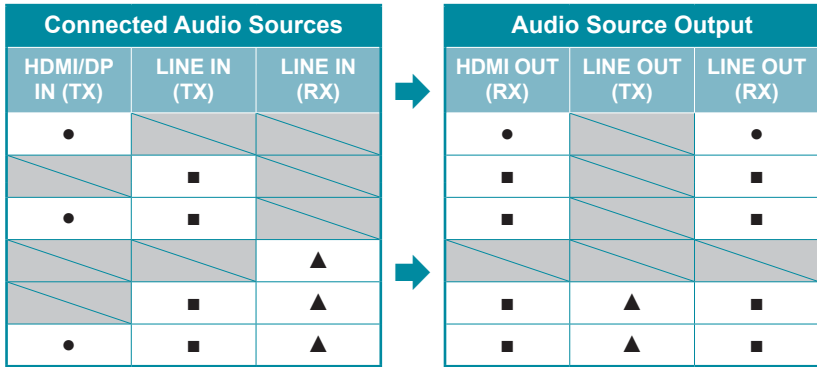

#### Multicast Data Transmission Mode

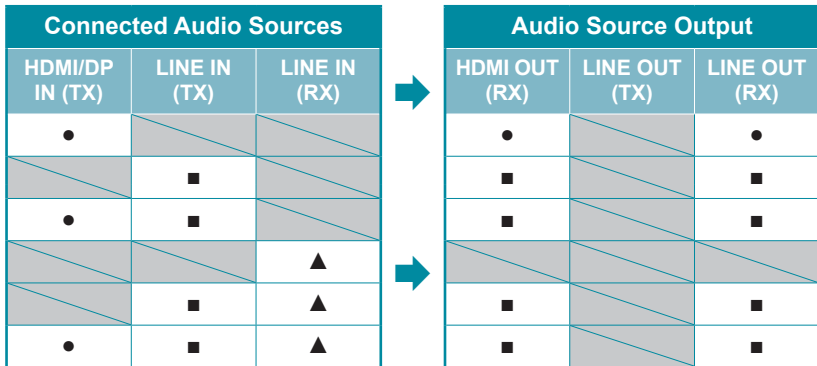

Legend:

- = HDMI/DisplayPort audio source.
- = Line In (Transmitter) audio source.
- ▲ = Line In (Receiver) audio source.

## 8.4 Cable Specifications

Cable Length	1080p		4K30	4K60
	8-bit	12-bit	(4:4:4) 8-bit	(4:4:4) 8-bit
<b>High Speed HDMI Cable</b>				
HDMI Input	15m	10m	5m	×
HDMI Output	15m	10m	5m	×
<b>DisplayPort Cable</b>				
DisplayPort Input	15m	10m	2m	×
<b>Ethernet Cable</b>				
Cat.5e/6	100m			×
Cat.6A/7	100m			×
<b>Fiber Cable</b>				
Multi-mode Fiber (OM3)	300m			×
Multi-mode Fiber (OM4)	550m			×
Single-mode Fiber	2km			×

### Bandwidth Category Examples:

- **1080p (FHD Video)**
  - Up to 1080p@60Hz, 12-bit color
  - Data rates lower than 5.3Gbps or below 225MHz TMDS clock
- **4K30 (4K UHD Video)**
  - 4K@24/25/30Hz & 4K@50/60Hz (4:2:0), 8-bit color
  - Data rates higher than 5.3Gbps or above 225MHz TMDS clock but below 10.2Gbps
- **4K60 (4K UHD<sup>+</sup> Video)**
  - 4K@50/60Hz (4:4:4, 8-bit)
  - 4K@50/60Hz (4:2:0, 10-bit HDR)
  - Data rates higher than 10.2Gbps



## 9. ACRONYMS

ACRONYM	COMPLETE TERM
<b>ADC</b>	Analog-to-Digital Converter
<b>ASCII</b>	American Standard Code for Information Interchange
<b>AVoIP</b>	Audio/Video over IP
<b>Cat.5e</b>	Enhanced Category 5 cable
<b>Cat.6</b>	Category 6 cable
<b>Cat.6A</b>	Augmented Category 6 cable
<b>Cat.7</b>	Category 7 cable
<b>CLI</b>	Command-Line Interface
<b>DAC</b>	Digital-to-Analog Converter
<b>dB</b>	Decibel
<b>DHCP</b>	Dynamic Host Configuration Protocol
<b>DP</b>	DisplayPort
<b>DVI</b>	Digital Visual Interface
<b>EDID</b>	Extended Display Identification Data
<b>GbE</b>	Gigabit Ethernet
<b>Gbps</b>	Gigabits per second
<b>GUI</b>	Graphical User Interface
<b>HDCP</b>	High-bandwidth Digital Content Protection
<b>HDMI</b>	High-Definition Multimedia Interface
<b>HDR</b>	High Dynamic Range
<b>IGMP</b>	Internet Group Management Protocol
<b>IP</b>	Internet Protocol
<b>IR</b>	Infrared
<b>kHz</b>	Kilohertz
<b>KVM</b>	Keyboard/Video/Mouse
<b>LAN</b>	Local Area Network
<b>LED</b>	Light-Emitting Diode
<b>LPCM</b>	Linear Pulse-Code Modulation

<b>ACRONYM</b>	<b>COMPLETE TERM</b>
<b>MAC</b>	Media Access Control
<b>MJPEG</b>	Motion JPEG
<b>MHz</b>	Megahertz
<b>OM</b>	Optical Multi-mode
<b>OPT</b>	Optical
<b>OSD</b>	On-Screen Display
<b>PoE</b>	Power over Ethernet
<b>SNR</b>	Signal-to-Noise Ratio
<b>TCP</b>	Transmission Control Protocol
<b>THD+N</b>	Total Harmonic Distortion plus Noise
<b>4K UHD</b>	4K Ultra-High-Definition (10.2Gbps max)
<b>4K UHD<sup>+</sup></b>	4K Ultra-High-Definition (18Gbps max)
<b>UHDTV</b>	Ultra-High-Definition Television
<b>USB</b>	Universal Serial Bus
<b>VGA</b>	Video Graphics Array
<b>VLAN</b>	Virtual LAN
<b>VoIP</b>	Video over IP
<b>WUXGA (RB)</b>	Widescreen Ultra Extended Graphics Array (Reduced Blanking)
<b>XGA</b>	Extended Graphics Array
<b>Ω</b>	Ohm





**CYPRESS TECHNOLOGY CO., LTD.**  
[www.cypress.com.tw](http://www.cypress.com.tw)

---