



# CMPRO-U4H4CVPL

4×4 HDMI 4K UHD over CAT5e/6/7 Matrix



Operation Manual



## DISCLAIMERS

The information in this manual has been carefully checked and is believed to be accurate. Cypress Technology assumes no responsibility for any infringements of patents or other rights of third parties which may result from its use.

Cypress Technology assumes no responsibility for any inaccuracies that may be contained in this document. Cypress also makes no commitment to update or to keep current the information contained in this document.

Cypress Technology reserves the right to make improvements to this document and/or product at any time and without notice.

## COPYRIGHT NOTICE

No part of this document may be reproduced, transmitted, transcribed, stored in a retrieval system, or any of its part translated into any language or computer file, in any form or by any means—electronic, mechanical, magnetic, optical, chemical, manual, or otherwise—without express written permission and consent from Cypress Technology.

© Copyright 2011 by Cypress Technology.

All Rights Reserved.

Version 1.1 August 2011

## TRADEMARK ACKNOWLEDGMENTS

All products or service names mentioned in this document may be trademarks of the companies with which they are associated.

HDBaseT™ and the HDBaseT Alliance logo are trademarks of the HDBaseT Alliance.





## SAFETY PRECAUTIONS

Please read all instructions before attempting to unpack, install or operate this equipment and before connecting the power supply.

Please keep the following in mind as you unpack and install this equipment:

- Always follow basic safety precautions to reduce the risk of fire, electrical shock and injury to persons.
- To prevent fire or shock hazard, do not expose the unit to rain, moisture or install this product near water.
- Never spill liquid of any kind on or into this product.
- Never push an object of any kind into this product through any openings or empty slots in the unit, as you may damage parts inside the unit.
- Do not attach the power supply cabling to building surfaces.
- Use only the supplied power supply unit (PSU). Do not use the PSU if it is damaged.
- Do not allow anything to rest on the power cabling or allow any weight to be placed upon it or any person walk on it.
- To protect the unit from overheating, do not block any vents or openings in the unit housing that provide ventilation and allow for sufficient space for air to circulate around the unit.

## REVISION HISTORY

VERSION NO.	DATE DD/MM/YY	SUMMARY OF CHANGE
RDV1	15/05/14	Preliminary Release
RDV2	18/09/14	Add RS-232 Command
VS1	10/12/14	Updated text/diagrams



# CONTENTS

<b>1. Introduction</b> .....	<b>1</b>
<b>2. Applications</b> .....	<b>1</b>
<b>3. Package Contents</b> .....	<b>1</b>
<b>4. System Requirements</b> .....	<b>2</b>
<b>5. Features</b> .....	<b>2</b>
<b>6. Operation Controls and Functions</b> .....	<b>3</b>
6.1 Front Panel .....	3
6.2 Rear Panel.....	4
6.3 Remote Control.....	5
6.4 IR Cable Pin Assignment.....	6
6.5 RS-232 Pin Assignment .....	6
6.6 RS-232 and Telnet Commands .....	7
6.7 RS-232 UART Command Diagram ..	9
6.8 Telnet Control .....	10
6.9 Web GUI Control.....	12
<b>7. Connection Diagram</b> .....	<b>13</b>
<b>8. Specifications</b> .....	<b>14</b>
8.1 Technical Specification.....	14
8.2 Input/Output Resolution.....	15
8.3 CAT5e/6/7 Cable Specification ...	16
<b>9. Acronyms</b> .....	<b>16</b>





## 1. INTRODUCTION

The 4 by 4 HDMI 4K UHD over CAT5e/6/7 Matrix supports the transmission of video (resolutions up to 4K2K and Full HD), multi-channel digital audio and control via IR, RS-232, Telnet or Web GUI from four high definition sources to four HDBase™ outputs over a single CAT5e/6/7 cable (up to 60m at 1080p and 35m at 4K2K) for each output.

It supports passthrough of high resolution digital audio formats such as LPCM 7.1CH, Dolby TrueHD, Dolby Digital Plus and DTS-HD Master Audio as well as 3D content that can be displayed when connecting a 3D TV and 3D source.

Additionally, the Power over Cable (PoC) function can power compatible Receivers, providing greater flexibility in installations.

## 2. APPLICATIONS

- HDMI matrix system
- Video/TV wall display and control
- Security surveillance and control
- Commercial advertising, display and control
- University lecture hall, display and control
- Retail sales and demonstration

## 3. PACKAGE CONTENTS

- 1×4 by 4 HDMI 4K UHD over CAT5e/6/7 Matrix
- 1×IR Extender
- 1×IR Blaster
- 1×24V/3.75A DC Power Adaptor
- 1×Power Cord
- 1×IR Remote Control with Battery
- 1×Set of Rack Ears
- 1×Operation Manual

## 4. SYSTEM REQUIREMENTS

- HDMI equipped source devices, connect with HDMI cables or DVI equipped source, connect with DVI to HDMI cables
- HDMI equipped displays (TVs or monitors) or HDMI equipped AV Receivers, connect with HDMI cables
- Industry standard CAT5e/6/7 cables
- Compatible HDBaseT™ receivers such as CH-506RXPL

## 5. FEATURES

- HDMI, HDCP1.1 and DVI compliant
- Supports HDMI 3D features for compatible sources and displays
- Supports resolutions from VGA to WUXGA and 4K2K @50/60 (YUV 420) dependent upon the output display's resolution capabilities
- Supports distances up to 60 meters at 1080p and 35 meters at 4K2K through CAT5e/6/7 cables
- Supports HDMI input/output cable lengths up to 10 meters at 1080p (8-bit/12-bit resolution) or 5 meters at 4K2K resolution
- Supports bi-directional IR from the input and output locations
- Supports control of the matrix via RS-232, remote control, on-panel control and IP Control (Telnet/Web GUI)
- 1U size design
- Supports external and internal EDID settings
- Supports passthrough of LPCM 7.1CH, Dolby TrueHD, Dolby Digital Plus and DTS-HD Master Audio
- Supports Power-over-Cable (PoC) to compatible HDBaseT receivers

Note:

1. *Do not connect the CAT5e/6/7 output of the matrix to the receiver's LAN port.*
2. *The PoC function is designed for powering compatible receiver units only, non-PoC receivers will need their own power supply. Receivers of another brand may not be compatible.*
3. *Please do not connect more than one active Ethernet link to the Matrix system, doing so may trigger the unit to shut down.*

## 6. OPERATION CONTROLS AND FUNCTIONS

### 6.1 Front Panel

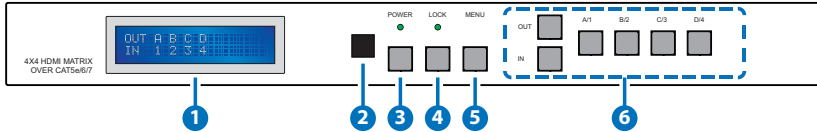

- 1 **LCM:** Displays information about the input and output settings.
- 2 **IR RECEIVE WINDOW:** Accepts the remote control signal for this unit only.
- 3 **POWER:** Press this button to power the unit on/off. The LED will illuminate green when the power is on, red when it is in 'Standby' mode.
- 4 **LOCK:** Press this button to lock all the buttons on the panel; press again to unlock. The LED will illuminate when locked.
- 5 **MENU:** Press this button to access the LCM menu system, from here EDID settings can be managed and IP system settings can be displayed.
- 6 **A~D/1~4 and OUT/IN:** Press the OUT or IN button to select the output or input mode and then press the required number button to confirm the selection.

For example, if outputs A and B need to be set to input 1 and outputs C and D need to be set to input 2, then the following sequence of button presses need to be performed:

Press: OUT→A→B→IN→1→MENU,

and then press: OUT→C→D→IN→2→MENU.

*Note: If the MENU button is not pressed the selection will not be changed.*



## 6.2 Rear Panel

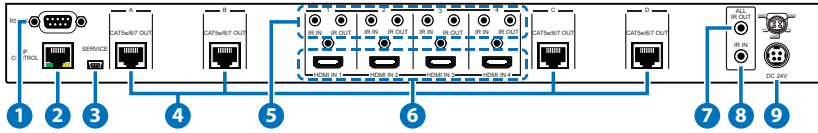

- 1 **RS-232:** Connect to a PC or RS-232 control system with a D-sub 9-pin cable for the transmission of RS-232 commands.

*Note: This unit has a routable RS-232 function that can route commands sent to the matrix to all receivers or accept matrix control commands from connected receivers. In order for the receivers to send commands to control the matrix, a null modem cable/adaptor is required (see Section 6.7 for details).*

- 2 **IP CONTROL:** This port is the link for Telnet or Web GUI controls, connect to an active Ethernet link with an RJ45 terminated cable (see Sections 6.8 and 6.9 for details).

**Warning: Please do not connect more than one active Ethernet link within the Matrix system.**

- 3 **SERVICE:** Manufacturer use only.

- 4 **CAT5e/6/7 OUT A~D:** Connect the CAT outputs to the CAT input ports of compatible receiver units with a single CAT5e/6/7 cable for HDMI Audio/Video and IR/RS-232 control signal transmission.

**Warning: Please do not connect the CAT5e/6/7 output of the matrix to the receiver's LAN port.**

- 5 **IR IN 1~4:** Connect the IR Extenders for IR signal reception. Ensure that the remote being used is within the direct line-of-sight of the IR extender. The signal received will be transmitted from the IR OUT of the selected receiver unit.

**IR OUT 1~4:** Connect to the IR Blasters for IR signal transmission. Place the IR blaster in direct line-of-sight of the equipment to be controlled. It will transmit the IR signal received from IR extenders connected to the matrix or receivers according to the selected input.

- 6 **HDMI IN 1~4:** Connect to HDMI/DVI source devices such as DVD players or Set-top boxes with HDMI cables or DVI to HDMI cables.

- 7 **ALL IR OUT:** Connect an IR Blaster for IR signal transmission to the



source/input location. Place the IR Blaster in direct line-of-sight of the equipment to be controlled. It will transmit all IR signals received by any IR extenders connected to receiver units.

- 8 **ALL IR IN:** Connect an IR Extender for IR signal reception. Ensure that remote being used is within the direct line-of-sight of the IR extender. IR signals received will be transmitted by all IR blasters connected to the receiver units.
- 9 **DC 24V:** Plug the 24 V DC power supply into the unit and connect the adaptor to an AC outlet.

### 6.3 Remote Control

- 1 **POWER:** Press this button to switch the unit ON or to put it into standby mode
- 2 **IN:** Input selection 1 to 4. Press to select the required input setting.
- 3 **OUT:** Output selection A to D. Press to select the required output setting.

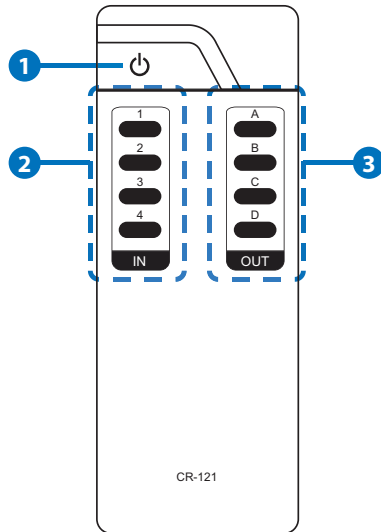

## 6.4 IR Cable Pin Assignment

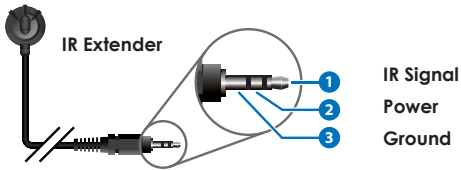
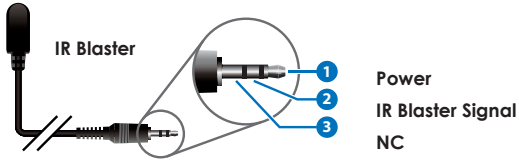

## 6.5 RS-232 Pin Assignment

MATRIX	
Pin	Assignment
1	NC
2	Tx
3	Rx
4	NC
5	GND
6	NC
7	NC
8	NC
9	NC



REMOTE CONTROL CONSOLE	
Pin	Assignment
1	NC
2	Rx
3	Tx
4	NC
5	GND
6	NC
7	NC
8	NC
9	NC

Baud Rate: 19200 bps

Data Bit: 8-bit

Parity: None

Stop Bit: 1-bit

Flow Control: None

## 6.6 RS-232 and Telnet Commands

COMMAND	DESCRIPTION
<b>A1~A4</b>	Set output A to input 1~4
<b>B1~B4</b>	Set output B to input 1~4
<b>C1~C4</b>	Set output C to input 1~4
<b>D1~D4</b>	Set output D to input 1~4
<b>AB...1~AB...4</b>	Set output A~D to input 1~4 simultaneously
<b>SETIP &lt;IP&gt; &lt;SubNet&gt; &lt;GW&gt;</b>	Set the IP, Subnet and Gateway configuration (Static IP)
<b>RSTIP</b>	Reset IP configuration to default values (DHCP)
<b>IPCONFIG</b>	Show the current IP configuration
<b>P0</b>	Power off
<b>P1</b>	Power on
<b>STORE 01~04</b>	Store the current input and output connections (01~04)
<b>PRESET 01~04</b>	Recall the stored input and output connections (01~04)
<b>SHOW 01~04</b>	Show the input and output of the stored connections (01~04)
<b>NAME N1 N2</b>	Name the stored input and output connections (N1=01~04) less than 8 characters (N2=A~H)
<b>I1~I4</b>	Set all outputs to input 1~4
<b>ST</b>	Show the current matrix state and firmware version
<b>RS</b>	Reset the system to A1, B2, C3, D4, E5, F6, G7, H8

COMMAND	DESCRIPTION
<b>EM</b>	Set the EDID mode to 1 (STD) or 2 (TV)
<b>UARTBAUD1~6</b>	Set the UART Baud rate of all outputs to 1~6 (1=9600bps, 2=14400bps, 3=19200bps, 4=38400bps, 5=57600bps, 6=115200bps)
<b>UARTBAUD?</b>	Show the UART Baud rate of all outputs
<b>UARTSW1~4</b>	Set the UART routing to output A, B, C or D and allow the matrix to send RS-232 commands to devices connected to the receivers
<b>UARTSWO</b>	Set the UART routing to MCU and restore RS-232 control of the Matrix
<b>UARTSW?</b>	Show the UART routing status
<b>?</b>	Show all available commands
<b>HELP</b>	Show all available commands
<b>QUIT</b>	Exit (Telnet only)

Note:

1. *Commands will not be executed unless followed by a carriage return. Commands are not case-sensitive.*
2. *STD EDID supports EDID settings of 1080p video/2CH audio. TV EDID supports EDID settings of the display connected to Output A.*

## 6.7 RS-232 UART Command Diagram

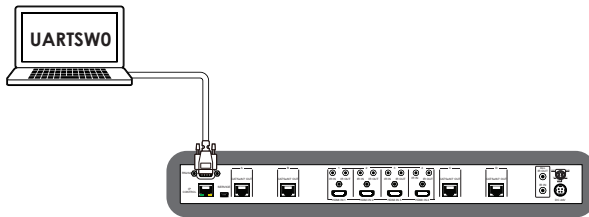

*Note: This command allows RS-232 control of the Matrix.*

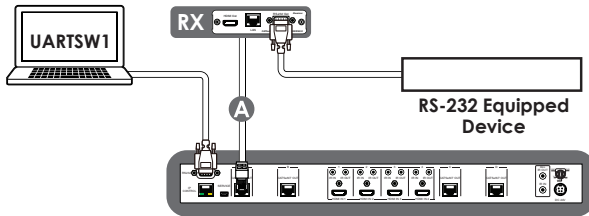

*Note: This command allows RS-232 control of the device attached to RS-232 output of Receiver connected to Output A.*

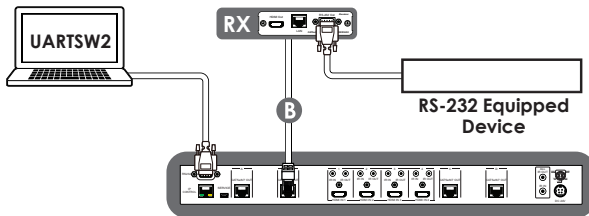

*Note: This command allows RS-232 control of the device attached to RS-232 output of Receiver connected to Output B.*

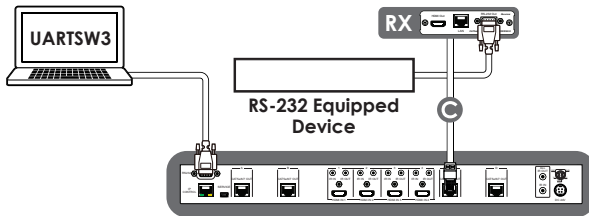

*Note: This command allows RS-232 control of the device attached to RS-232 output of Receiver connected to Output C.*

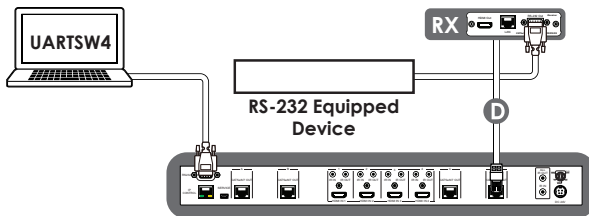

*Note: This command allows RS-232 control of the device attached to RS-232 output of Receiver connected to Output D.*

## 6.8 Telnet Control

Before attempting to use the telnet control, please ensure that both the Matrix (via the 'IP CONTROL' port) and the PC/Laptop are connected to the same active network.

To access the telnet control in Windows 7, click on the 'Start' menu and type "cmd" in the Search field then press enter.

Under Windows XP go to the 'Start' menu and click on 'Run', type "cmd" with then press enter.

Under Mac OS X, go to Go→Applications→Utilities→Terminal. See below for reference.

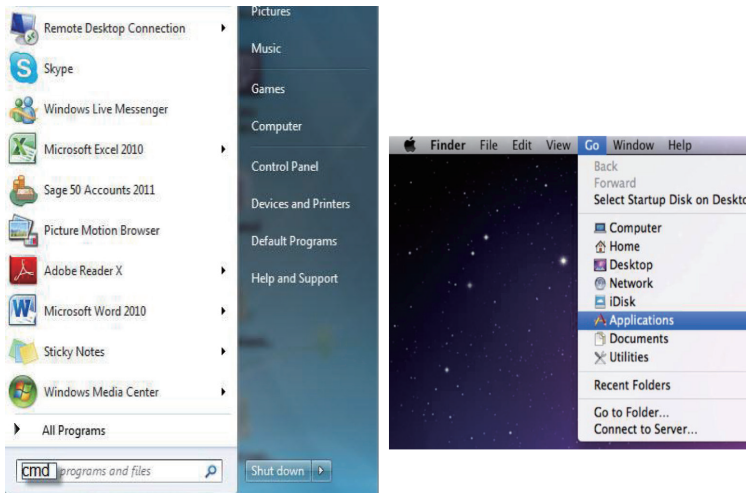



Once in the command line interface (CLI) type "TELNET", then the IP address of the unit and '23', then hit enter.

*Note: The IP address of the Matrix can be displayed on the unit's LCM monitor by pressing the Menu button twice.*

```
Microsoft Windows [Version 6.1.7600]
Copyright (c) 2009 Microsoft Corporation. All rights reserved.

C:\Users\CYP>telnet 192.168.5.80 23_
```

This will bring us into the device which we wish to control. Type "HELP" to list the available commands.

```
telnet-> ?

A1~A4 : Switch Output A to 1~4
B1~B4 : Switch Output B to 1~4
C1~C4 : Switch Output C to 1~4
D1~D4 : Switch Output D to 1~4
ABCD...1~ABCD...4 : Switch output ABCD... to 1~4 at the same time
SETIP <IP> <SubNet> <GW> : Setting IP.SubNet.GateWay(Static IP)
RSTIP : IP Configuration Was Reset to Factory Defaults(DHCP)
IPCONFIG : Display the current IP config
P0 : Power Off
P1 : Power On
STORE 01~04: STORE current I/O position <01~04>
PRESET 01~04: RECALL the store I/O position <01~04>
SHOW 01~04: SHOW current port's I/O position <01~04>
NAME N1 N2: NAME the stored port N1<01~04> no more than 8 charactors
ABCDEFGH)
I1~I4 : Switch all the output to 1~4
ST : Display the current matrix state and firmware version
RS : System Reset to A1,B2,C3,D4
EM : Setting EDID MODE. 1-$TD 2-TU.
UARTBAUD1~UARTBAUD4 : Setting outputA~D's uart baud <1:9600bps,2:14400bps,3:
0bps,4:38400bps,5:57600bps,6:115200bps>
UARTSW1~UARTSW4 : Switch output's uart to A~D
UARTSW0 : Switch output's uart to MCU
UARTSW? : Display the uart switching state
? : Display all available commands
QUIT : Exit
```

Type "IPCONFIG" to show all IP configurations. To reset the IP, type "RSTIP" and to use a set static IP, type "SETIP" (For a full list of commands, see Section 6.7).

*Note: Commands will not be executed unless followed by a carriage return. Commands are not case-sensitive. If the IP is changed then the IP Address required for Telnet access will also change accordingly.*



## 6.9 Web GUI Control

On a PC/Laptop that is connected to the same active network as the Matrix, open a web browser and type the unit's IP address on the web address entry bar. The browser will display the unit's status, control and user setting pages.



Click on the 'Control' tab to control power, input/output ports, EDID and reset mode.

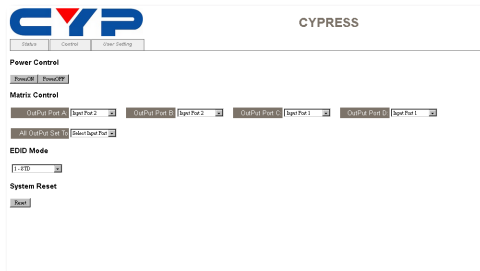

Click on the 'User Setting' tab allows you to reset the IP configuration. The system will ask for a reboot of the unit when any of the settings are changed. The IP address needed to access the WebGUI control will also need to be changed accordingly on the web address entry bar.

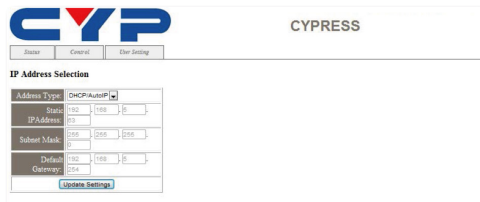

## 7. CONNECTION DIAGRAM

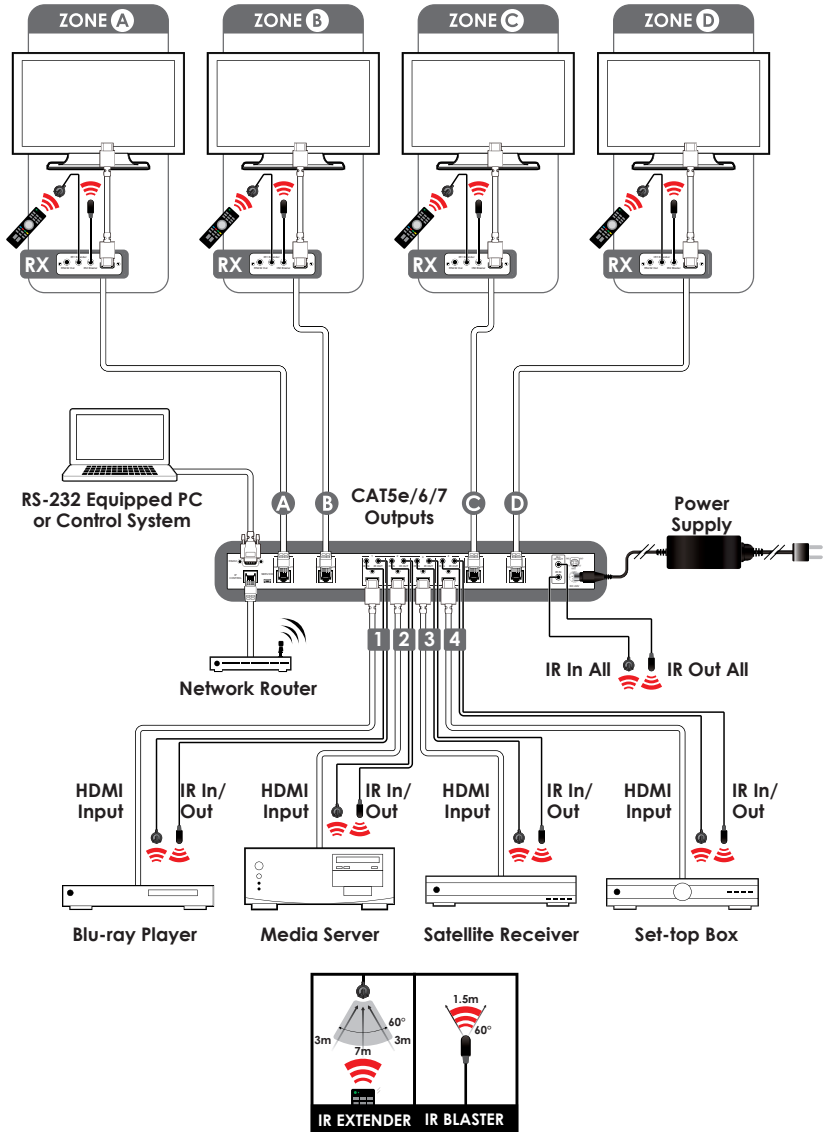

## 8. SPECIFICATIONS

### 8.1 Technical Specification

<b>Video Bandwidth</b>	340MHz/10.2Gbps
<b>Input Ports</b>	4×HDMI, 5×IR Extender, 1×RS-232, 1×RJ-45 (Control), 1×Mini USB Type B (For firmware updated only)
<b>Output Ports</b>	4×CAT5e/6/7, 5×IR Blaster
<b>Supported HDMI Cable Lengths</b>	10m@1080p, 5m@4K2K (Input/output)
<b>ESD Protection</b>	Human-body Model: ± 8kV (Air-gap discharge) ± 4kV (Contact discharge)
<b>Power Supply</b>	24V/3.75A DC (US/EU standards, CE/FCC/UL certified)
<b>Dimensions</b>	436 mm (W)×249 mm (D)×44 mm (H)/Jacks Excluded 436 mm (W)×256.2mm (D)×48 mm (H)/Jacks Included
<b>Weight</b>	3352g
<b>Chassis Material</b>	Metal
<b>Silkscreen Color</b>	Black
<b>Operating Temperature</b>	0 °C~40 °C/32 °F~104 °F
<b>Storage Temperature</b>	-20 °C~60 °C/-4 °F~140 °F
<b>Relative Humidity</b>	20~90% RH (non-condensing)
<b>Power Consumption</b>	66W



## 8.2 Input/Output Resolution

SUPPORTED RESOLUTION	INPUT	OUTPUT
640×480@60/72/75/85	✓	✓
800×600@56/60/72/75/85	✓	✓
1024×768@60/70/75/85	✓	✓
1280×720@60	✓	✓
1280×1024@60	✓	✓
1600×1200@60	✓	✓
1920×1200@60RB	✓	✓
3840×2160p@24/25/30	✓	✓
4096×2160p@24	✓	✓
4096×2160p@50/60 (YUV 420)	✓	✓
480i/576i	✓	✓
480p/576p	✓	✓
720p@50/60	✓	✓
1080i@50/60	✓	✓
1080p@50/60	✓	✓
1080p@24/25/30	✓	✓

### 8.3 CAT5e/6/7 Cable Specification

Cable Type	Range	Pixel Clock Rate	Video Data Rate	Supported Video
<b>CAT5e/6/7</b>	60m	≤225 MHz	≤5.3 Gbps (HD Video)	Up to 1080p@60Hz, 36-bit 3D (data rates lower than 5.3 Gbps or below 225 MHz TMDs clock).

## 9. ACRONYMS

ACRONYM	COMPLETE TERM
<b>CLI</b>	Command Line Interface
<b>DTS</b>	Digital Theater System
<b>DVI</b>	Digital Visual Interface
<b>EDID</b>	Extended Display Identification Data
<b>GUI</b>	Graphical User Interface
<b>HDCP</b>	High-bandwidth Digital Content Protection
<b>HDMI</b>	High-Definition Multimedia Interface
<b>HDTV</b>	High-Definition Television
<b>LCM</b>	Liquid Crystal Module
<b>USB</b>	Universal Serial Bus
<b>VGA</b>	Video Graphics Array
<b>WUXGA</b>	Widescreen Ultra Extended Graphics Array







**CYPRESS TECHNOLOGY CO., LTD**

Home page: <http://www.cypress.com.tw>

MPM-CMPROU4H4CVPL