



CMPRO-UA8H8CVE

8×8 HDMI 4K UHD over CAT5e/6/7 Matrix
with HDCP 2.2



HDCP2.2

Operation Manual

DISCLAIMERS

The information in this manual has been carefully checked and is believed to be accurate. Cypress Technology assumes no responsibility for any infringements of patents or other rights of third parties which may result from its use.

Cypress Technology assumes no responsibility for any inaccuracies that may be contained in this document. Cypress also makes no commitment to update or to keep current the information contained in this document.

Cypress Technology reserves the right to make improvements to this document and/or product at any time and without notice.

COPYRIGHT NOTICE

No part of this document may be reproduced, transmitted, transcribed, stored in a retrieval system, or any of its part translated into any language or computer file, in any form or by any means—electronic, mechanical, magnetic, optical, chemical, manual, or otherwise—without express written permission and consent from Cypress Technology.

© Copyright 2011 by Cypress Technology.

All Rights Reserved.

Version 1.1 August 2011

TRADEMARK ACKNOWLEDGMENTS

All products or service names mentioned in this document may be trademarks of the companies with which they are associated.





SAFETY PRECAUTIONS

Please read all instructions before attempting to unpack, install or operate this equipment and before connecting the power supply.

Please keep the following in mind as you unpack and install this equipment:

- Always follow basic safety precautions to reduce the risk of fire, electrical shock and injury to persons.
- To prevent fire or shock hazard, do not expose the unit to rain, moisture or install this product near water.
- Never spill liquid of any kind on or into this product.
- Never push an object of any kind into this product through any openings or empty slots in the unit, as you may damage parts inside the unit.
- Do not attach the power supply cabling to building surfaces.
- Use only the supplied power supply unit (PSU). Do not use the PSU if it is damaged.
- Do not allow anything to rest on the power cabling or allow any weight to be placed upon it or any person walk on it.
- To protect the unit from overheating, do not block any vents or openings in the unit housing that provide ventilation and allow for sufficient space for air to circulate around the unit.

REVISION HISTORY

VERSION NO.	DATE (DD/MM/YY)	SUMMARY OF CHANGE
VR0	16/11/15	Preliminary release



CONTENTS

1. Introduction	1
2. Applications	1
3. Package Contents	1
4. System Requirements	2
5. Features	2
6. Operation Controls and Functions	3
6.1 Front Panel	3
6.2 Rear Panel.....	4
6.3 Side Panel	5
6.4 Remote Control.....	6
6.5 IR Cable Pin Assignment.....	6
6.6 RS-232 Protocol.....	7
6.7 RS-232 and Telnet Commands	7
6.8 Telnet Control	9
6.9 WebGUI Control	11
7. Connection Diagram	13
8. Specifications	15
8.1 Technical Specifications	15
8.2 CAT5e/6/7 Cable Specification ...	16
8.3 HDBT Feature	16
8.4 Supported Resolutions	17
9. Acronyms	18





1. INTRODUCTION

The 8 by 8 HDMI 4K2K Matrix over CAT5e/6/7 supports the transmission of video (resolutions up to 4K2K Full HD & HDCP 2.2), multi-channel digital audio and control via IR, RS-232, Telnet or Web GUI from eight high definition sources to eight outputs over a single CAT5e/6/7 cable (up to 100m) for each output.

It supports high resolution digital audio formats such as LPCM 7.1CH, Dolby TrueHD, Dolby Digital Plus and DTS-HD Master Audio as well as 3D content that can be displayed when connecting a 3D TV and 3D source.

Additionally, the LAN connectivity will allow a 100BaseT network to be served to smart TVs or games consoles. The Power over Cable (PoC) function can power compatible receivers, providing greater flexibility in installations.

2. APPLICATIONS

- HDMI Matrix System
- Video/TV wall display and control
- Security surveillance and control
- Commercial advertising, display and control
- University lecture hall, display and control
- Retail sales and demonstration

3. PACKAGE CONTENTS

- 1×8 by 8 HDMI 4K UHD over Cat5e/6/7 Matrix
- 1×IR Blaster
- 1×IR Extender
- 1×Remote Control with battery
- 2×24V/6.25A Power Adaptor
- 2×Power Cord
- 1×Operation Manual

4. SYSTEM REQUIREMENTS

- HDMI equipped source devices, connect with HDMI cables or DVI equipped source, connect with DVI to HDMI cables
- HDMI equipped displays (TVs or monitors) or HDMI equipped AV receivers, connect with HDMI cables
- Industry standard CAT5e/6/7 cables
- HDBase™ Receivers

5. FEATURES

- HDMI with 4K2K supported, HDCP 2.2 and DVI compliant
- Supports PC resolution up to WUXGA and HDTV resolution up to 4K2K(3840×2160@24/25/30Hz & 3840×2160@50/60Hz with YUV420, 4096×2160@24/25/30Hz & 4096×2160@50/60Hz with YUV420)
- Supports distances up to 100 meters through CAT5e/6/7 cable
- Supports 3D signal bypass
- Supports pass-through audio LPCM 2/5.1/7.1CH, Dolby Digital 2/5.1CH, DTS 2/5.1CH, Dolby TrueHD & DTS-HD Master Audio
- Supports PoC (Power over Cable) on compatible receivers only
- Supports bidirectional IR from inputs and output locations
- Supports RS-232, remote control, on-panel control and IP control (Telnet/Web GUI)
- Supports LAN serving function through the LAN port
- 2U size design
- Compliant with DVI source

Note:

1. *The PoC function is designed for powering compatible receiver units only—non-PoC receivers will need their own power supply. Receivers of another brand may not be compatible.*
2. *Do not connect the LAN port to CAT outputs of this device or to CAT inputs or receiver. Doing so may damage the unit.*

6. OPERATION CONTROLS AND FUNCTIONS

6.1 Front Panel

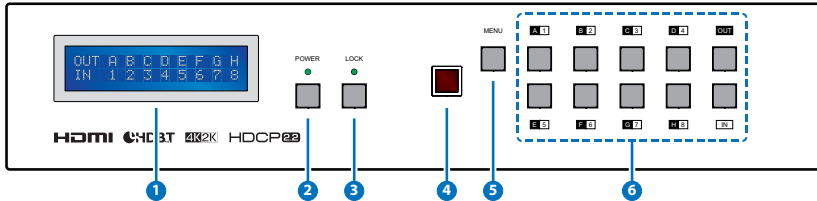

- ❶ **LCM** : Displays the setting information of each input and output setting.
- ❷ **POWER**: Press this button to power the device ON/OFF. The LED will illuminate green when the power is on, red when it is in 'Standby' mode.
- ❸ **LOCK**: Press this button to lock all the buttons on the panel; press again to unlock. The LED will illuminate orange when locked.
- ❹ **IR WINDOW**: Accepts the remote control signal of this device only.
- ❺ **MENU**: Press this button to access the LCM menu system, from here EDID settings can be managed and IP system settings are displayed.
- ❻ **1~8/A~H and IN/OUT**: Press the Out or In button to select the output or input mode and then press the required number button to make the selection accordingly.

For example, if outputs A~D need to be set to input 1 and outputs E~H need to be set to input 2, then the following sequence of button presses need to be performed:

Press: Out →A→B→C→D→In→1→Menu,
and then press: Out→E→F→G→H→In→2→Menu.

Note: If the menu button is not pressed the selection will not be changed.

6.2 Rear Panel

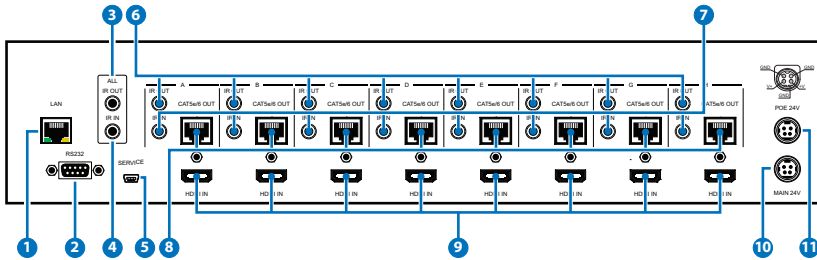

- 1 LAN:** Connect to an active network for LAN serving and Telnet and Web GUI control (refer to Sections 6.8 and 6.9).

When the Matrix or any compatible LAN equipped receivers are connected to a network, this allows the network access (including internet access if available) to be shared between the Matrix and all connected receivers. Connect any Ethernet equipped device e.g. a Smart TV or games console to the LAN port of a receiver for that device to share the network/internet access.

Warning: Please do not connect this port directly to the PC/Laptop as the Telnet function will not work.

- 2 RS-232:** Connect to a PC or control system with D-Sub 9-pin cable to control the matrix with RS-232 commands (refer to Sections 6.6 and 6.7).
- 3 ALL IR OUT:** Connect an IR Blaster for IR signal transmission to the source/input location. Place the IR Blaster in direct line-of-sight of the equipment to be controlled. It will transmit all IR signals received by any IR extenders connected to the matrix or receivers.
- 4 ALL IR IN:** Connect an IR extender for IR signal reception. Ensure that remote being used is within the direct line-of-sight of the IR extender. IR signals received will be transmitted by all IR blasters connected to the matrix or receivers.
- 5 SERVICE:** Manufacturer use only.
- 6 IR OUT 1~8:** Connect to the IR blasters for IR signal transmission. Place the IR blaster in direct line-of-sight of the equipment to be controlled. It will transmit the IR signal received from IR extenders connected to the matrix or receivers according to the selected input.
- 7 IR IN 1~8:** Connect to the IR extenders for IR signal reception. Ensure

that remote being used is within the direct line-of-sight of the IR extender. The IR signal will be transmitted to the selected receiver's IR OUT.

- 8 CAT5e/6/7 OUT 1~8:** Connect from these CAT outputs to the CAT input port of the receiver units with a single CAT5e/6/7 cable for HDMI Audio/Video and IR/RS-232 control signal transmission.

Warning: Please do not connect the CAT5e/6/7 output into the receiver's LAN port.

- 9 HDMI IN 1~8:** Connect to the HDMI input source devices such as a DVD player or a Set-top Box with HDMI cable or DVI to HDMI cable.
- 10 DC 24V MAIN POWER:** Plug the 24 V DC power supply into the unit and connect the adaptor to an AC outlet.
- 11 PoE 24V:** Plug the 24V PoE power supply into the unit and connect the adaptor to an AC outlet. This unit provides the power supply for PoE (Power over Ethernet) capable receiver units.

6.3 Side Panel

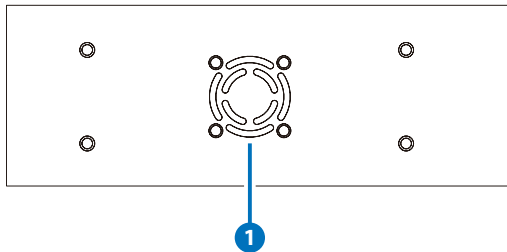

- 1 Fan Ventilator:** These are air ventilation areas, DO NOT block these areas or cover with any object. Please allow adequate space around the unit for air to circulate.

6.4 Remote Control

- 1 POWER:** Press this button to switch on the device or set it to standby mode.
- 2 IN:** Input ports selection 1~8.
- 3 OUT:** Output ports selection A~H.

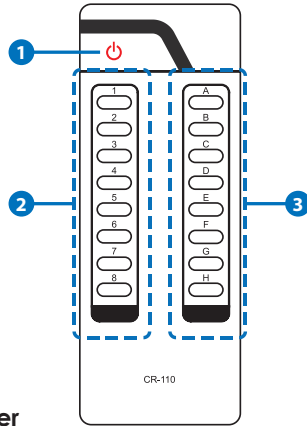

6.5 IR Cable Pin Assignment

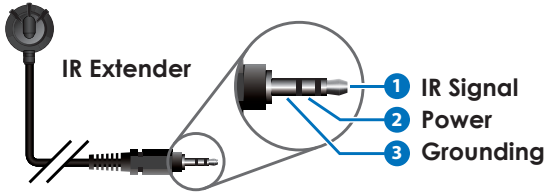
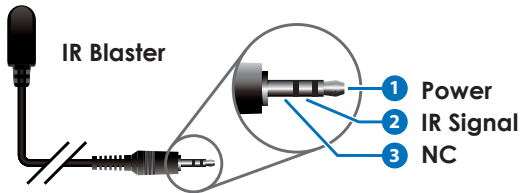

6.6 RS-232 Protocol

MATRIX			REMOTE CONTROLLER	
Pin	Assignment		Pin	Assignment
1	NC		1	NC
2	TX		2	RX
3	RX		3	TX
4	NC	▶	4	NC
5	GND	◀	5	GND
6	NC		6	NC
7	NC		7	NC
8	NC		8	NC
9	NC		9	NC

Baud Rate: 115200bps
 Data bit: 8 bits
 Parity: None
 Flow Control: None
 Stop Bit: 1

6.7 RS-232 and Telnet Commands

COMMAND	DESCRIPTION	PARAMETER
AN	Switch output A to input N.	N=1~8
BN	Switch output B to input N.	N=1~8
CN	Switch output C to input N.	N=1~8
DN	Switch output D to input N.	N=1~8
EN	Switch output E to input N.	N=1~8
FN	Switch output F to input N.	N=1~8
GN	Switch output G to input N.	N=1~8
HN	Switch output H to input N.	N=1~8
IN	Switch all outputs to input N.	N=1~8
AB.....N	Switch output AB... to input N.	N=1~8

COMMAND	DESCRIPTION	PARAMETER
SETIP <x.x.x.x><x.x.x.x><x.x.x.x>	Set IP, SubNet and Gateway (Static IP)	X=0~255
IPCONFIG	Display the current IP configuration	NONE
RSTIP	Set IP configuration to DHCP	None
P0	Power off	None
P1	Power on	None
STOREN	Store current I/O to position N	N=1~8
SHOWN	Show current port N I/O position	N=1~8
PRESETN	Preset the store I/O position N	N=1~8
NameN N1	Name port N as N1	N=1~8, N1=A~H (Max Length=8)
ST	Show unit firmware version	None
EMN	Setting EDID mode N	N=0(STD) 1(TV) 2(USER)
RS	Routing reset to default	None
USBISP	Update firmware via USB	None
UARTSW?	Display the UART switching state	None
UARTSWN	Switch output's UART to port N	N=0 (out console), 1~8
UARTBAUD?	Display all output's UART baud	None
UARTBAUDN N1	Setting RS-232 routing port N to Baud rate N1	N=1~8, N1=1~6 (1=9600bps, 2=14400bps, 3=19200bps, 4=38400bps, 5=57600bps, 6=115200bps)
HELP(?)	Display all available commands	None
@FADEFAULT	Set to factory default	None
QUIT	Quit Telnet	None

Note: Any commands will not be executed unless followed by a



carriage return. Commands are case-insensitive.

6.8 Telnet Control

Before attempting to use the Telnet control, please ensure that both the Matrix (via the 'LAN /CONTROL' port) and the PC/Laptop are connected to the same active networks.

To access the Telnet control in Windows 7, click on the 'Start' menu and type "cmd" in the Search field then press enter.

Under Mac OS X, go to Go→Applications→Utilities→Terminal

See below for reference.

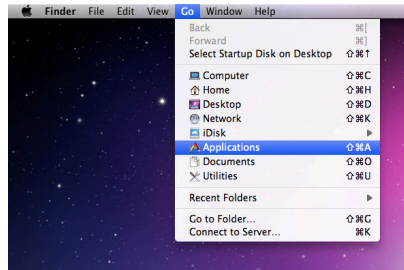
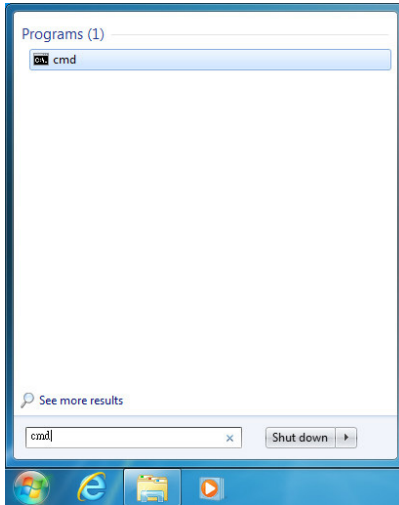

Once in the command line interface (CLI) type "telnet", then the IP address of the unit and "23", then hit enter.

```
Microsoft Windows [Version 6.1.7601]
Copyright (c) 2009 Microsoft Corporation. All rights reserved.

C:\Users\Administrator>telnet 192.168.5.175
```

This will bring us into the unit which we wish to control. Type "help" to list the available commands.

```

Welcome to TELNET.
>?
SETIP      : SET ETHERNET IP ADDRESS
IPCONFIG   : DISPLAY THE CURRENT IPCONFIG
RSTIP      : IP CONFIGURATION RESET TO <DHCP>
P0         : POWER OFF
P1         : POWER ON
STORE      : STORE current I/O position <01~08>
SHOW       : SHOW current port's I/O position <01~08>
PRESET     : PRESET the store I/O position <01~08>
NAME       : NAME N1 N2
the stored port N1<01~08> no more than 8 charactors N2<ABCDEFGH>
I1~I8     : SET ALL OUTPUTS SOURCE
ST         : SHOW UNIT FIRMWARE VERSION
RS         : System Reset to
EM         : Setting EDID MODE. 1-STD 2-TU 3-USER.
USBISP     : Update FW by USB
A1~A8     : SET OUTPUT A SOURCE(1-8)
B1~B8     : SET OUTPUT B SOURCE(1-8)
C1~C8     : SET OUTPUT C SOURCE(1-8)
D1~D8     : SET OUTPUT D SOURCE(1-8)
E1~E8     : SET OUTPUT E SOURCE(1-8)
F1~F8     : SET OUTPUT F SOURCE(1-8)
G1~G8     : SET OUTPUT G SOURCE(1-8)
H1~H8     : SET OUTPUT H SOURCE(1-8)
AB..1~AB..8 : Switch output ABCD... to 1~8 at the same time
UARTSW?    : Display the uart switching state
UARTBAUD?  : Display all the output's uart baud
UARTSW     : Switch output's uart to A~H
UARTSW0    : Switch output's uart to MCU
UARTBAUD   : Setting outputA~H's uart baud <1:9600bps,2:14400bps,3:19200bps,4:3
8400bps,5:57600bps,6:115200bps>
?          : SHOW DESCRIPT OF COMMAND
QUIT      : Telnet QUIT

```

Note: Commands will not be executed unless followed by a carriage return. Commands are case-insensitive. If the IP is changed then the IP Address required for Telnet access will also change accordingly.

6.9 WebGUI Control

On a PC/Laptop which is connected to an active network system, open a web browser and type device's IP address (available from LCM monitor or OSD menu) on the web address entry bar. Once login account and password, the browser will display the device's Switch, Data Routing, EDID Settings and System Settings.

A login form with a blue 'Login' button at the top left. Below it are two input fields: 'Username' and 'Password'. At the bottom center is a 'Submit' button.

Click 'Switch' page to switch Input and output setting.

The screenshot shows the 'Switch' configuration page in the webGUI. On the left is a sidebar with menu items: 'Switch', 'Data Routing', 'Edid Settings', and 'System Settings'. The main content area is titled 'Switch' and is divided into two columns: 'Output' and 'Input'. Each column contains a list of 8 items, each with a checkbox and a 'No Signal' status.

Output	Input
A OUTPUT 1 from INPUT 1 No Signal	1 Input 1 No Signal
B OUTPUT 2 from INPUT 2 No Signal	2 Input 2 No Signal
C OUTPUT 3 from INPUT 3 No Signal	3 Input 3 No Signal
D OUTPUT 4 from INPUT 4 No Signal	4 Input 4 No Signal
E OUTPUT 5 from INPUT 5 No Signal	5 Input 5 No Signal
F OUTPUT 6 from INPUT 6 No Signal	6 Input 6 No Signal
G OUTPUT 7 from INPUT 7 No Signal	7 Input 7 No Signal
H OUTPUT 8 from INPUT 8 No Signal	8 Input 8 No Signal

Version: V0.2

Click on 'Data Routing' page to set up Output Baud rate and Uart Routing status.

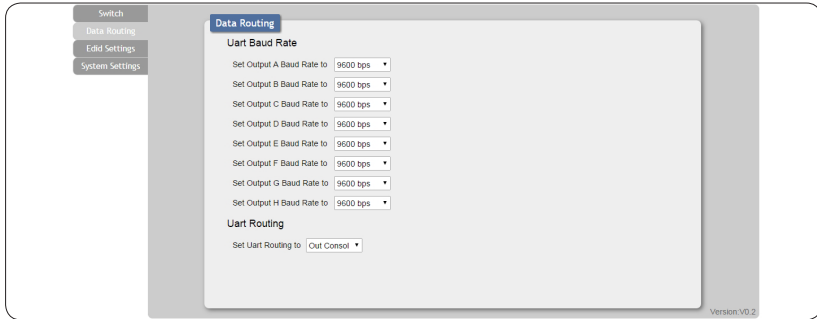

Click on 'EDID Settings' page to Setting EDID mode or update EDID.



Click on 'System Settings' to control power on / off, Network status setting and reset to default settings.

Note: It will need to click on save button once you finished network parameters setting.

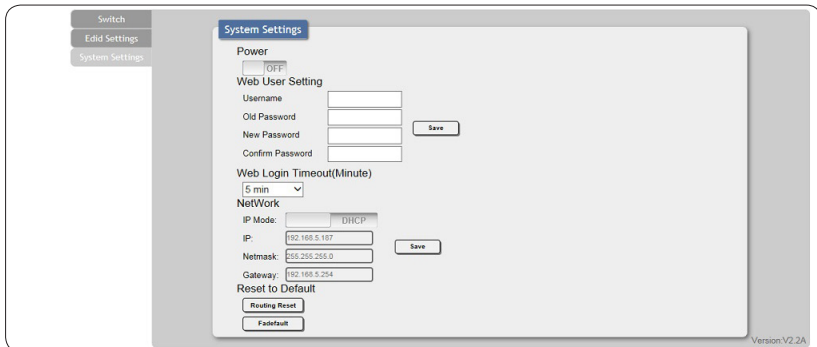

7. CONNECTION DIAGRAM

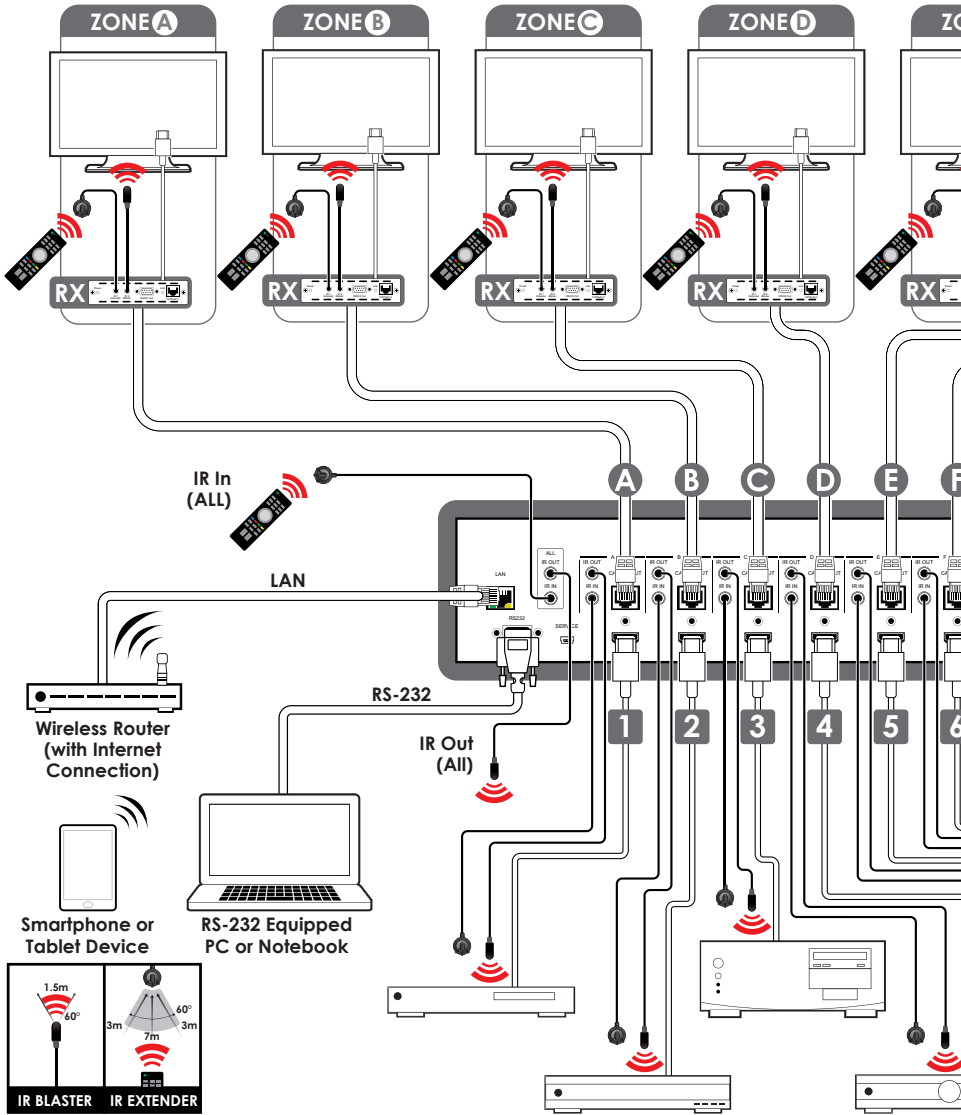

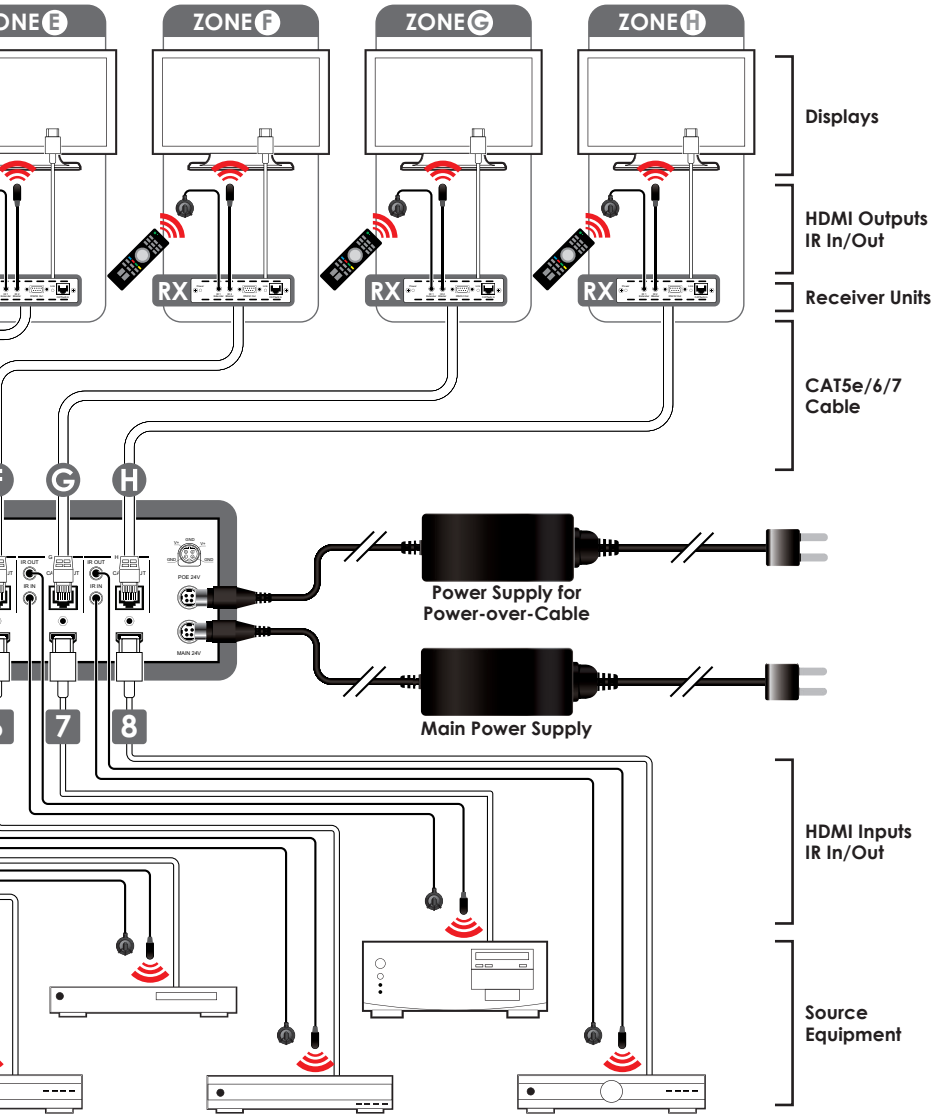



8. SPECIFICATIONS

8.1 Technical Specifications

Video Bandwidth	300 MHz/9 Gbps
Input Ports	8×HDMI, 9×IR (3.5mm), 1×RS-232 (9-pin D-sub), 1×LAN (RJ-45), 1×USB (Service only)
Output Ports	8×CAT5e/6/7, 9×IR (3.5mm)
Video Resolutions	480i~1080p@24/50/60, 4K@24/25/30, 4K@50/60 (YUV420) & VGA~WUXGA
IR Frequency	30~50 kHz
Baud Rate	115200 bps
Power Supply	24 V/6.25 A DC (US/EU standards, CE/FCC/UL certified)/Main & PoC
ESD Protection	Human body model: ±8 kV (air-gap discharge) ±6 kV (contact discharge)
Dimensions	438 mm (W)×249 mm (D)×88 mm (H)/ Jack Excluded 438 mm (W)×256.7 mm (D)×92 mm (H)/ Jack Included
Weight	4592 g
Chassis Material	Metal
Color	Black
Operating Temperature	0°C~40°C/32°F~104°F
Storage Temperature	-20°C~60°C/-4°F~140°F
Relative Humidity	20~90% RH (non-condensing)
Power Consumption	93.45 W

8.2 CAT5e/6/7 Cable Specification

Cable Type	Range	Pixel clock rate	Video Data Rate	Supported Video
CAT5e/6	100 m	<225MHz	<5.3Gbps (HD Video)	Up to 1080, 60Hz, 36bits 3D
	70 m	>225MHz	>5.3Gbps (UHD Video)	Deep color: 1080p, 60Hz, 48bpp 4K2K
Cat6a/7	100 m			

8.3 HDBT Feature

HDBT FEATURE	SUPPORT
Video & Audio	Yes
IR	No
RS232	No
Send Power to TX	Yes
Send Power to RX	Yes

8.4 Supported Resolutions

Resolution	Input	Output
640×480@60	√	√
720×480@60	√	√
720×576p@50	√	√
800×600@60	√	√
1024×768@60	√	√
1280×720@50	√	-
1280×720p@50	√	√
1280×720p@60	√	√
1280×1024@60	√	√
1600×1200@60	√	√
1920×1080i@50	√	√
1920×1080i@60	√	√
1920×1080p@24	√	√
1920×1080p@25	√	√
1920×1080p@30	√	√
1920×1080p@50	√	√
1920×1080p@60	√	√
1920×1200@60 (RB)	√	√
3840×2160@24	√	√
3840×2160@25	√	√
3840×2160@30	√	√
3840×2160@60	√	-
3840×2160@60 (YUV420)	√	√
4096×2160@24	√	√

9. ACRONYMS

ACRONYM	COMPLETE TERM
CAT5e	Category 5 Cable
CAT6	Category 6 Cable
CAT7	Category 7 Cable
CLI	Command Line Interface
DTS	Digital Theater System
DVI	Digital Visual Interface
GUI	Graphical User Interface
HDCP	High-bandwidth Digital Content Protection
HDMI	High-Definition Multimedia Interface
HDTV	High-Definition Television
IR	Infrared
LCM	Liquid Crystal Module
PoC	Power over Cable
USB	Universal Serial Bus
VGA	Video Graphics Array
WUXGA (RB)	Widescreen Ultra Extended Graphics Array (Reduce Blanking)



CYPRESS TECHNOLOGY CO., LTD
Home page: <http://www.cypress.com.tw>

MPM-UA8H8CVE