

peerless-AV[®]

GC-X360S-W

GC-X360S-B

**Game Console Security
Cover for Xbox 360S**

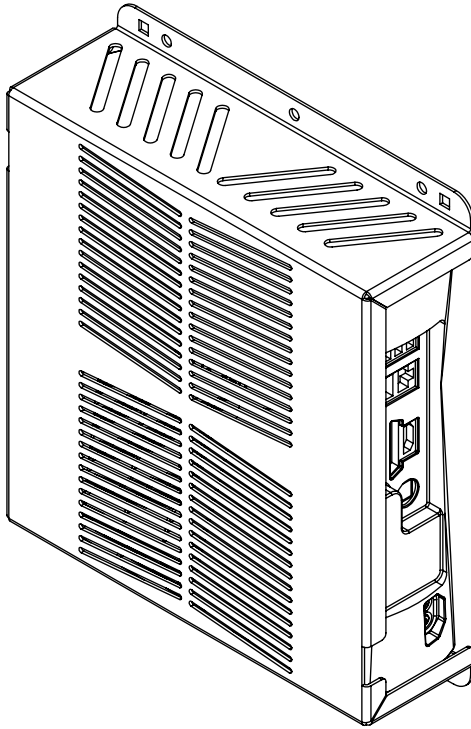

⚠ WARNING

ENG - This product was designed to be installed on wood stud, solid concrete or cinder block walls. Before installing make sure the supporting surface will support the combined load of the equipment and hardware. Screws must be tightly secured. Do not overtighten screws or damage can occur and product may fail. Never exceed the Maximum Load Capacity. Always use an assistant or mechanical lifting equipment to safely lift and position equipment. This product is intended for indoor use only. Use of this product outdoors could lead to product failure or personal injury. For support please call customer care at 1-800-865-2112.

Symbols



WARNING

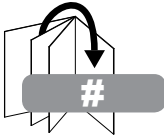

Skip to step.



Screws must get at least three full turns and fit snug.

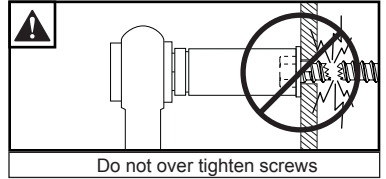

Do not over tighten screws



Display center.



To properly tighten screws: Tighten until screw head makes contact, then tighten another 1/2 turn. Do not overtighten screws.

1

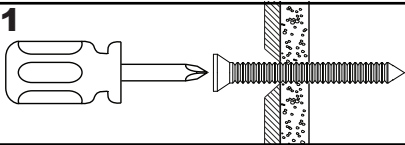

2

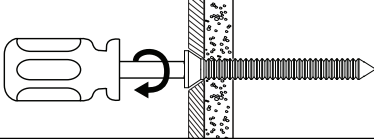

3

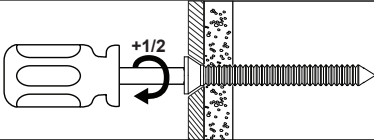

4

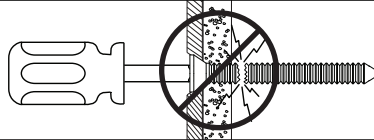

Tools Needed for Assembly.

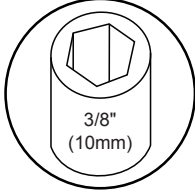
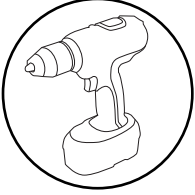
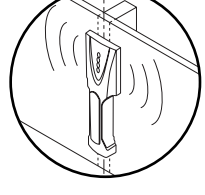
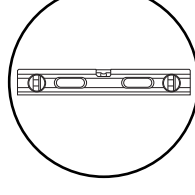
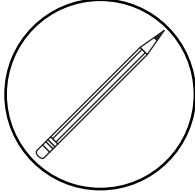
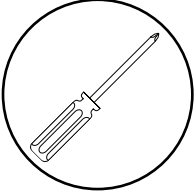
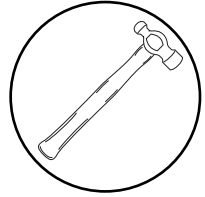
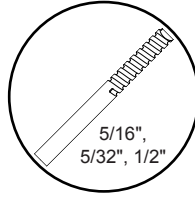
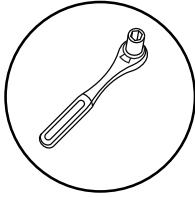
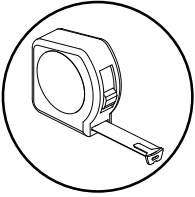

Parts List

	Part Description	Quantity	Part Number (-B)	Part Number (-W)
A	cover plate	1	125-P1455	125-2455
B	1/4-20 x 1.75" carriage bolt	4	520-1017	520-1017
C	#14 2 2.5" hex head wood screw	2	500-1005	500-1005
D	1/4-20 x 1.5" socket pin screw	4	520-1256	520-1256
E	concrete anchor	2	590-0320	590-0320
F	1/4 x 20 slope nut	3	530-0035	530-0035
G	plastic screw cap	4	590-1294	590-1294
H	4 mm allen wrench	1	560-9646	560-9646
I	1/4-20 plastic toggler	4	560-9708	560-9708
J	1/4-20 nylock nut	2	530-9413	530-9413

Before beginning, make sure you have all parts shown below

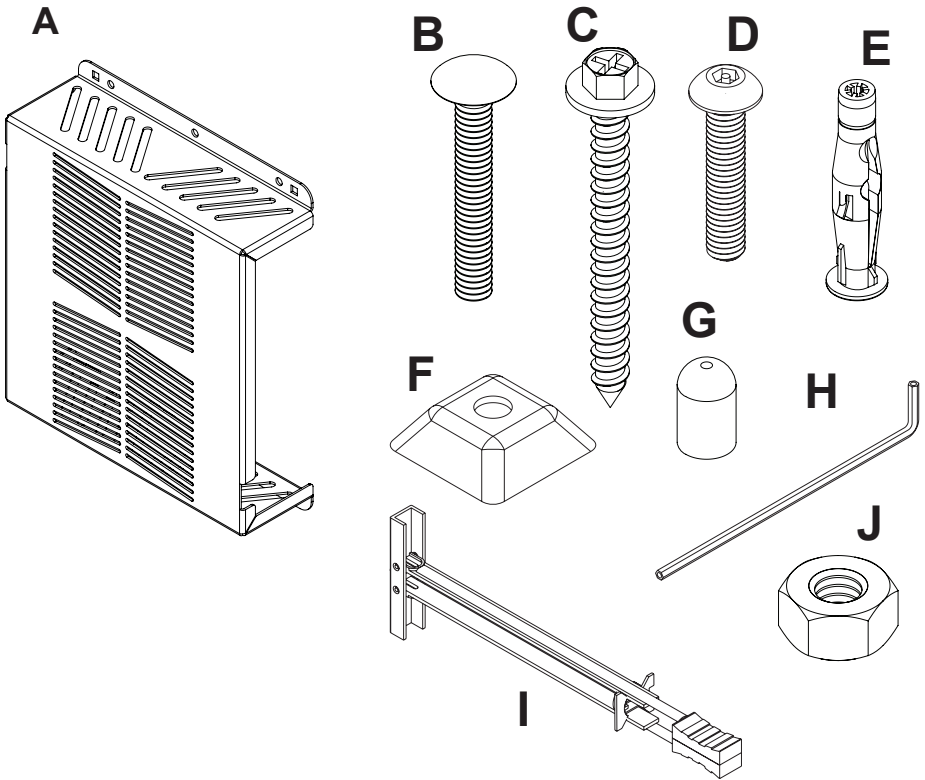

1

Wood stud wall.

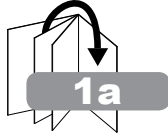
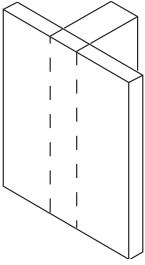

Concrete/Cinder block.

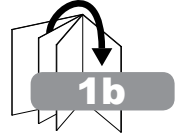
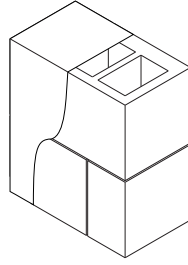

Drywall.

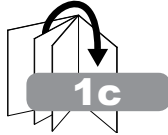
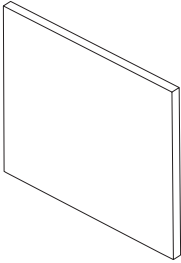

Desktop.

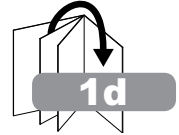
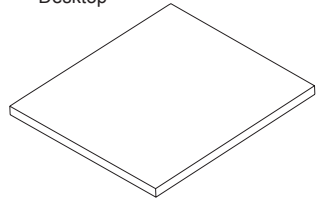

1a

▲ WARNING

When installing Peerless wall mounts on a wood stud wall covered with gypsum board (drywall), verify that the wood studs are a minimum of 2"X4" nominal size. When installing to more than one stud, insure the spacing between studs is at least 16" but does not exceed 24". Do not install over gypsum board thicker than 5/8".

1a-1

Use stud finder to locate and mark stud center lines.

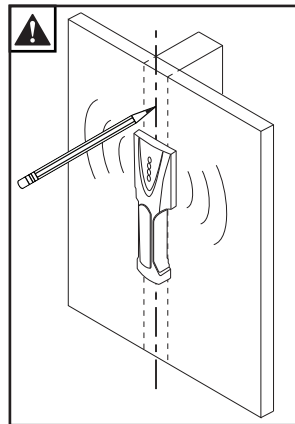
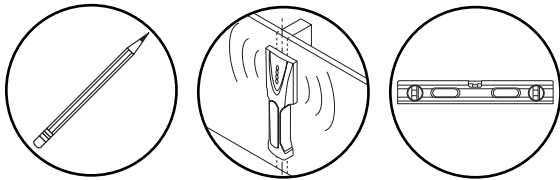

1a-2

Level cover plate. Mark mounting holes on stud center lines.

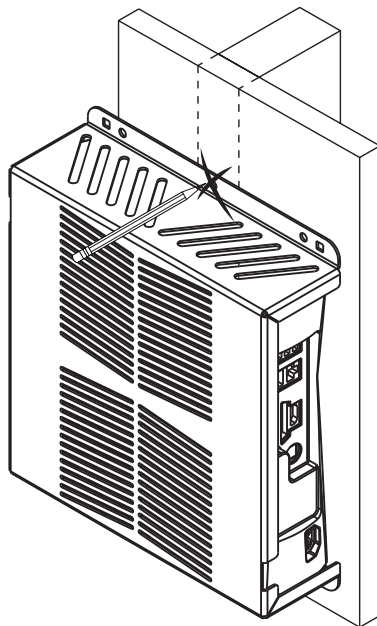
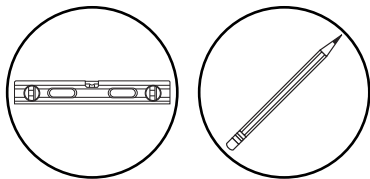

1a-3

Drill mounting holes into supporting surface (2.5" (64 mm) minimum depth required).

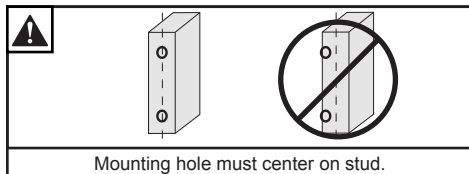
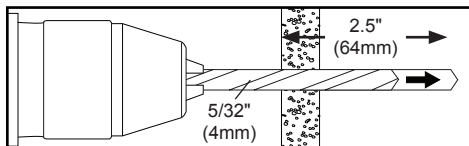
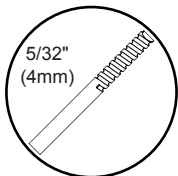

1a-4

Level cover plate. Install using wood screws provided.

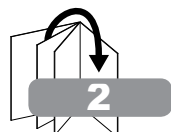
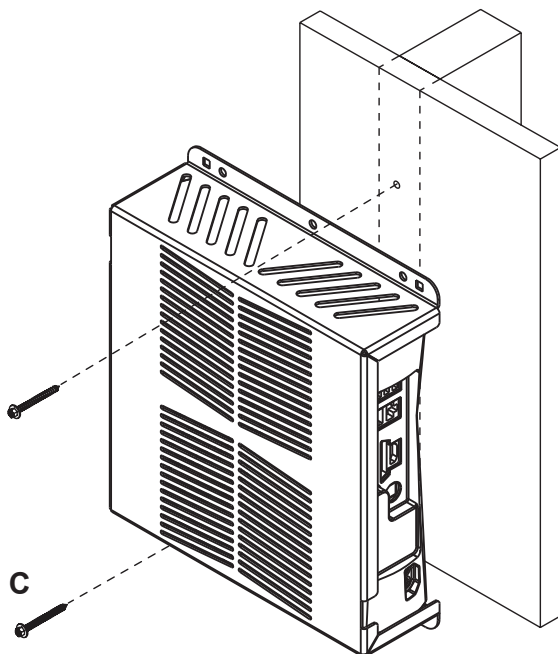
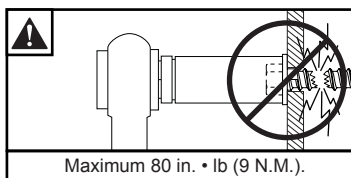
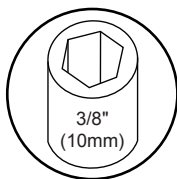
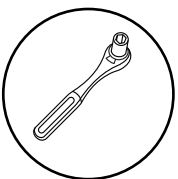
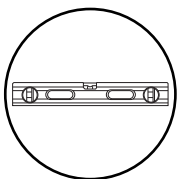

1b

⚠ WARNING

ENG • When installing Peerless wall mounts on a concrete wall, the wall must be at least 8" thick with a minimum compressive strength of 2000 psi.

• When installing Peerless wall mounts on a cinder block wall, the cinder blocks must meet ASTM C-90 specifications and have a minimum nominal width of 8". Do not drill into mortar joints! Be sure to mount in a solid part of the block, generally 1" (25 mm) minimum from the side of the block. It is suggested that a standard electric drill on slow setting is used to drill the hole instead of a hammer drill to avoid breaking out the back of the hole when entering a void or cavity.

• Never attach expansion anchors to concrete or cinder block covered with plaster, drywall or other finishing material.

1b-1

Level cover plate. Mark mounting holes.

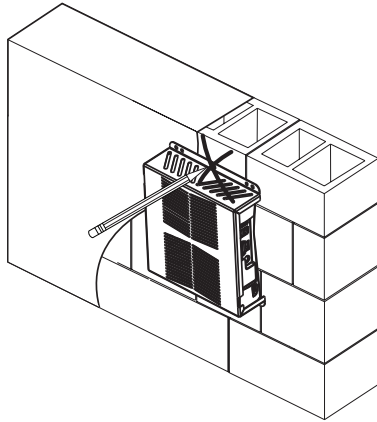
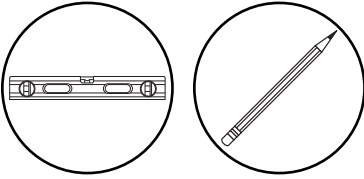

1b-2

Drill mounting holes into supporting surface (2.5" (64 mm) minimum depth required).

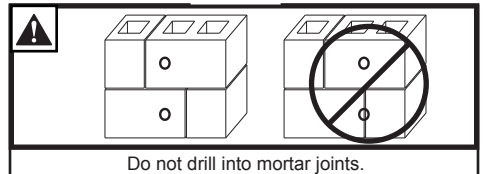
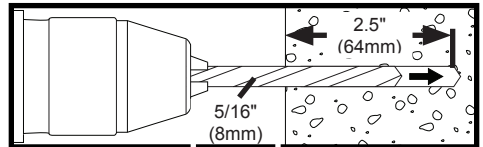
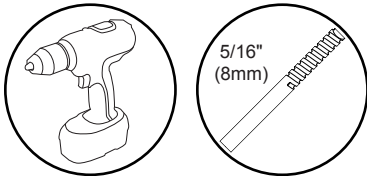

Do not drill into mortar joints.

1b-3

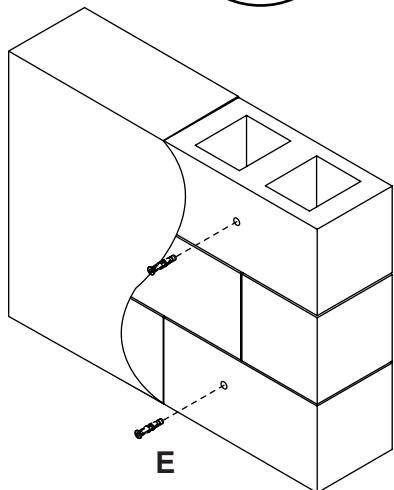
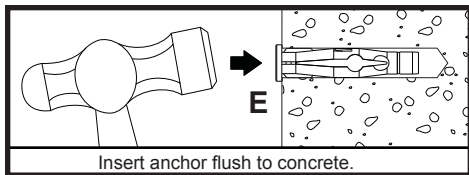
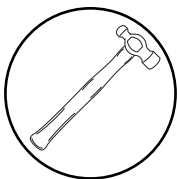

1b-4

Level wallplate. Install using concrete anchors and wood screws provided.

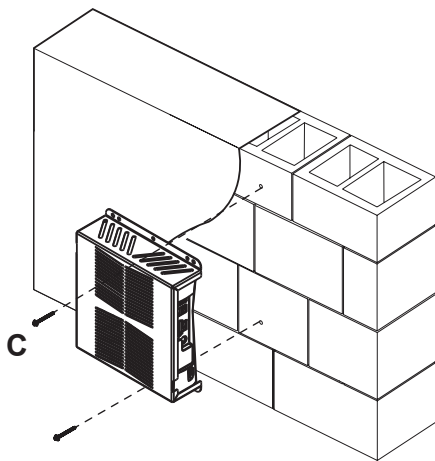
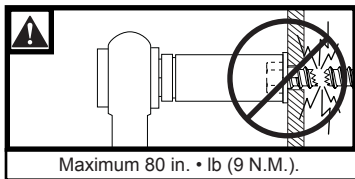
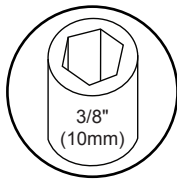
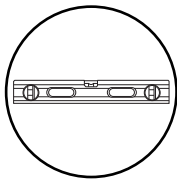

⚠ WARNING

- Drywall must be 1/2" or thicker.
- Make sure that the wall will safely support the combined load of the equipment and all attached hardware and components.

1c-1

Level cover plate and mark the center of the four mounting holes. Drill four 1/2" holes through drywall.

NOTE: It may be necessary to drill 5/32" pilot holes prior to drilling 1/2" holes.

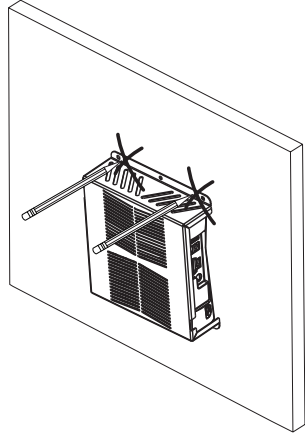
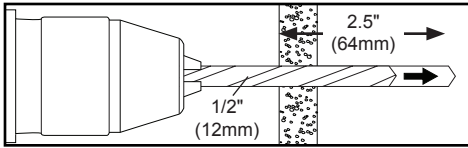

1c-2

fig. 1.3

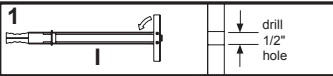

Pivot end of toggler (I).

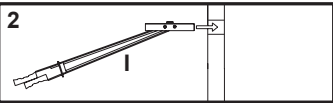

Push into hole.

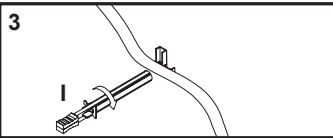

Rotate toggler (I) clockwise to wedge it against inside walls.

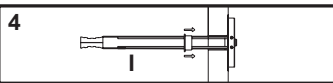

Slide plastic cap forward while pulling back firmly on ring.



Break off excess.

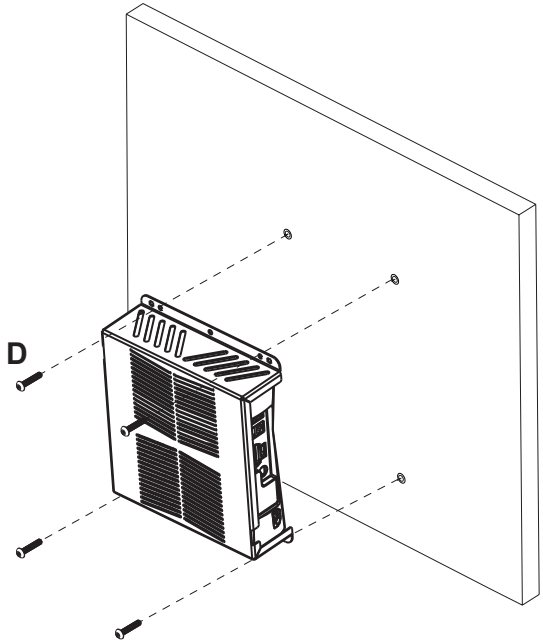

1d-1

Level cover plate and mark the center of four rectangular mounting holes

Drill four 5/16" (8 mm) dia. holes through desktop mounting surface

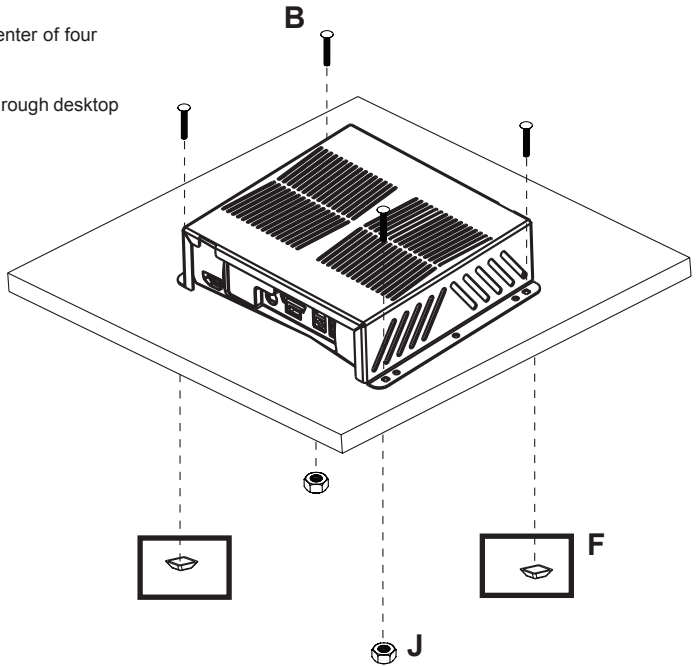
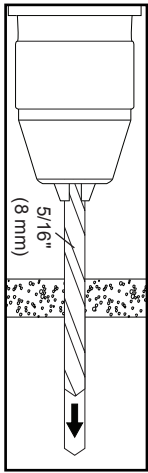

BOTTOM OF DESK

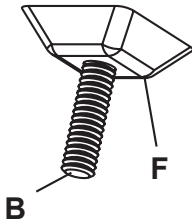

NOTE: Avoid jamming both slope nuts (F) together, doing so may make it difficult to remove slope nut used for tightening.
After slope nut is secure remove bottom slope nut.

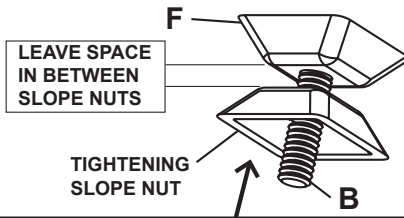

BOTTOM OF DESK

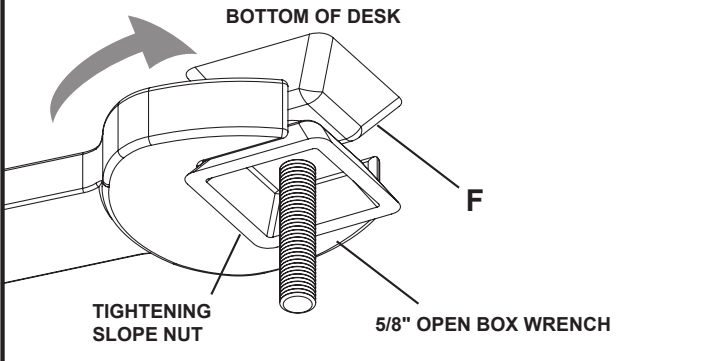

LIMITED FIVE-YEAR WARRANTY

Peerless Industries, Inc. ("Peerless") warrants to original end-users of Peerless® products will be free from defects in material and workmanship, under normal use, for a period of five years from the date of purchase by the original end-user (but in no case longer than six years after the date of the product's manufacture). At its option, Peerless will repair or replace, or refund the purchase price of, any product which fails to conform with this warranty.

In no event shall the duration of any implied warranty of merchantability or fitness for a particular purpose be longer than the period of the applicable express warranty set forth above. Some states do not allow limitations on how long a implied warranty lasts, so the above limitation may not apply to you.

This warranty does not cover damage caused by (a) service or repairs by the customer or a person who is not authorized for such service or repairs by Peerless, (b) the failure to utilize proper packing when returning the product, (c) incorrect installation or the failure to follow Peerless' instructions or warnings when installing, using or storing the product, or (d) misuse or accident, in transit or otherwise, including in cases of third party actions and force majeure.

In no event shall Peerless be liable for incidental or consequential damages or damages arising from the theft of any product, whether or not secured by a security device which may be included with the Peerless® product. Some states do not allow the exclusion or limitation of incidental or consequential damages, so the above limitation or exclusion may not apply to you.

This warranty is in lieu of all other warranties, expressed or implied, and is the sole remedy with respect to product defects. No dealer, distributor, installer or other person is authorized to modify or extend this Limited Warranty or impose any obligation on Peerless in connection with the sale of any Peerless® product.

This warranty gives specific legal rights, and you may also have other rights which vary from state to state.

The logo for Peerless-AV features the word "peerless" in a bold, lowercase, red sans-serif font. To its right, the letters "AV" are rendered in a red outline font, with a small registered trademark symbol (®) to the upper right of the "V".

Peerless-AV
2300 White Oak Circle
Aurora, IL 60502
Email: tech@peerlessmounts.com
Ph: (800) 865-2112
Fax: (800) 359-6500
www.peerless-av.com

© 2012, Peerless Industries, Inc.