



**1080P**  
PROGRESSIVE



# 16x16 DVI Matrix w/ Push Button Control

**GEF-DVI-16416-PB**

**User Manual**

**[www.gefenpro.com](http://www.gefenpro.com)**



## ASKING FOR ASSISTANCE

---

### Technical Support:

Telephone (818) 772-9100  
(800) 545-6900

Fax (818) 772-9120

### Technical Support Hours:

8:00 AM - 5:00 PM Monday through Friday, Pacific Time  
For 24 / 7 support, see the front panel of the product for the support number

### Write To:

Gefen, LLC  
c/o Customer Service  
20600 Nordhoff St  
Chatsworth, CA 91311

[www.gefenpro.com](http://www.gefenpro.com)  
[support@gefenpro.com](mailto:support@gefenpro.com)

### Notice

Gefen, LLC reserves the right to make changes in the hardware, packaging, and any accompanying documentation without prior written notice.

**16x16 DVI Matrix w/ Push Button Control**  
is a trademark of Gefen LLC

© 2015 Gefen, LLC. All rights reserved.  
All trademarks are the property of their respective owners.

**Rev A11**

# CONTENTS

---

|    |  |
|----|--|
| 1  | Introduction   |
| 2  | Operation Notes  |
| 3  | Features   |
| 4  | Front Panel Layout   |
| 5  | Front Panel Descriptions   |
| 6  | Back Panel Layout  |
| 7  | Back Panel Descriptions  |
| 8  | IR Remote Description  |
| 9  | IR Remote Installation   |
| 10 | IR Code Configuration  |
| 11 | Connecting And Operating The 16x16 DVI Matrix w/ Push Button Control |
| 11 | Wiring Diagram   |
| 12 | Front Panel Display  |
| 13 | Routing  |
| 13 | Routing Inputs to Outputs  |
| 14 | Getting the Current Routing Status of an Input                       |
| 15 | Getting the Current Routing Status of an Output                      |
| 15 | One-to-One Routing   |
| 16 | Presets  |
| 16 | Saving the Current Routing State                                     |
| 18 | Recalling a Saved Routing State                                      |
| 20 | Masking  |
| 20 | Masking Outputs  |
| 22 | Getting the Current Masking State                                    |
| 23 | Unmasking Outputs  |
| 25 | Locking the Matrix   |
| 26 | EDID Management  |
| 26 | Saving the Downstream EDID to an Input                               |
| 28 | Saving the Default EDID to an Input                                  |
| 30 | RS-232 / IP Control  |
| 30 | RS-232 Interface   |
| 30 | RS-232 Settings  |
| 31 | Using Syner-G  |
| 33 | RS-232 / Telnet / UDP Commands                                       |
| 33 | EDID Management  |
| 38 | IP Configuration   |
| 47 | Routing  |
| 50 | Masking  |
| 52 | Miscellaneous  |
| 60 | Web Interface  |
| 60 | View Matrix Status   |
| 64 | Manage EDID  |
| 70 | Masking  |
| 71 | IP Configuration   |
| 73 | Backup / Restore   |
| 74 | Power Management   |
| 76 | Network Cable Wiring Diagram   |
| 77 | Rack Mount Safety Information  |
| 78 | Specifications   |
| 79 | Warranty   |
| 80 | Licensing  |

# INTRODUCTION

---

Congratulations on your purchase of the GefenPRO 16x16 DVI Matrix w/ Front Panel Push Button Control. Your complete satisfaction is very important to us.

## **GefenPRO**

In the realm of video distribution, certain features are invaluable in a commercial or broadcast environment. Accommodations such as a build-in power supply and flat black rack-mount enclosures set GefenPRO apart from our traditional products. Complex distribution units allow for professional DVI, 3G-SDI, and HDMI signals to be routed and converted easily and seamlessly, while being backed up by a renowned and dependable technical support team. Gefen invites you to explore the GefenPRO product line and hopes that you find the solution that fits your needs.

## **The GefenPRO 16x16 DVI Matrix w/ Front Panel Push Button Control**

Simplify the process of routing up to 16 DVI sources to any of 16 DVI monitors without losing quality or resolution. This Matrix provides a simple, reliable, and highly effective method of streamlining any installation using multiple sources and outputs, taking the hassle out of managing multiple connections. Each DVI source is accessible at all times by any monitor using the front-panel buttons, IR remote unit, built-in RS-232 or using IP control.

## **How It Works**

Connect 16 sources to the DVI input ports on the Matrix using the supplied DVI cables. Connect 16 monitors to the Matrix. Power on the source devices and the monitors. Plug in the power cord and power on the Matrix. Use the push buttons on the front panel for routing each DVI source to the desired display. The connected monitors will display video according to the routing state.

**NOTE:** This Matrix only supports DVI-D. The DVI connectors on the Matrix all have 29 pins.

# OPERATION NOTES

---

## READ THESE NOTES BEFORE INSTALLING OR OPERATING THE GEFENPRO 16X16 DVI MATRIX W/ FRONT PANEL PUSH BUTTON CONTROL

- The 16x16 DVI Matrix w/ Push Button Control does not support HDCP content.
- Make sure that a DVI monitor is powered and connected to one of the DVI outputs on the 16x16 DVI Matrix w/ Push Button Control before applying power. By default, the Local EDID is read from the connected monitor and is copied to all 16 DVI inputs once the Matrix has been turned on. If a monitor is not detected by the Matrix at power-on, a default (internal) EDID of 640x480 will be used. This functionality can be disabled using the Secure Local EDID function using RS-232 or IP control.
- There is no internal scaling in the 16x16 DVI Matrix w/ Push Button Control. Each monitor attached to the Matrix must be able to display the resolutions output by the source device(s).  
For maximum compatibility it is recommended that only one common resolution be used by each source device.
- Advanced EDID features and IP configuration features are accessible through the RS-232 serial command set.
- Routing and EDID features can be managed using the built-in IP control feature.
- This matrix supports Dynamic EDID. See page 61 for details.
- The Gefen Syner-G Software Suite is a free downloadable application from Gefen that provides automatic download and installation of firmware upgrades for this product.

Download the application here: <http://www.gefen.com/synerg/>

- The Gefen Matrix Switcher Keyboard Controller is a free downloadable application from Gefen that allows a computer keyboard to be used to switch between sources. This application uses the Telnet protocol to control any Gefen switcher or matrix that uses IP control.

Download the application here: <http://www.gefen.com/support/download.jsp>



**IMPORTANT:** If the unit is installed in a closed or multi-rack assembly, do not block the ventilation holes of the enclosure.

# FEATURES

---

## Features

- Supports resolutions up to 1920 x 1200
- Front-panel push buttons for local switching
- Front-panel LCD Display
- Switching is controlled via front panel buttons, IR remote, IP, or RS-232 commands
- Compatible with the Gefen Keyboard Controller software
- Advanced EDID management
- Programmable routing presets
- Standby mode
- Output masking control
- IP control and configuration with built-in Web server
- Internal power supply
- Rack-mountable

## Package Includes

- (1) GefenPRO 16x16 DVI Matrix w/ Front Panel Push Button Control
- (16) 6 ft. DVI cables (M-M)
- (1) IR Remote Control Unit
- (1) AC Power Cord
- (1) Quick-Start Guide

# PANEL LAYOUT

## Front Panel

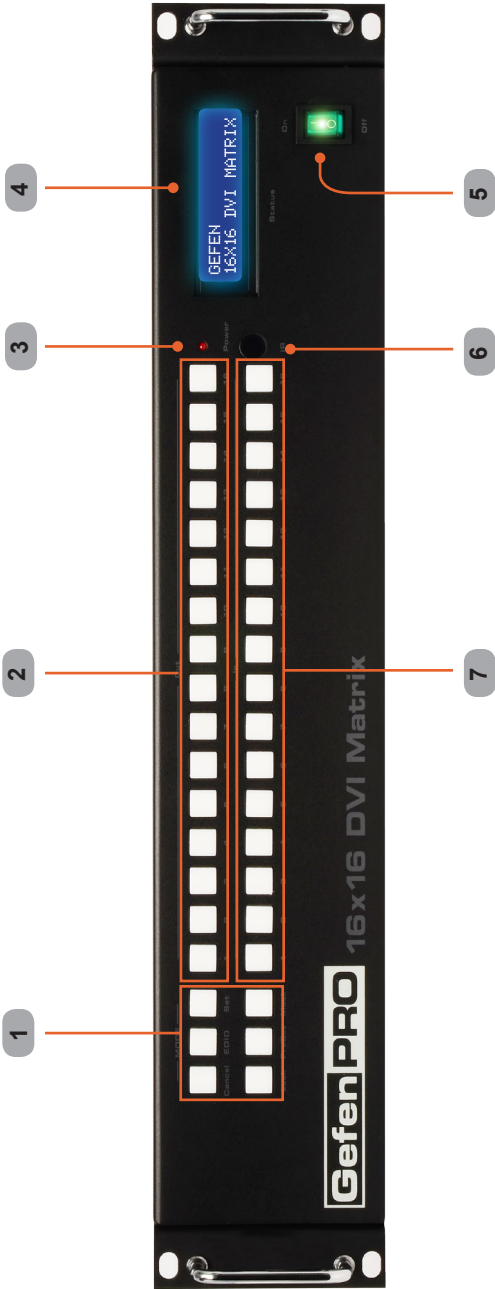



# PANEL DESCRIPTIONS

---

## Front Panel

**1 Mode Buttons**

These buttons are used to control routing, masking, presets on the matrix. See the information beginning with page 12 for more information.

**2 Output Buttons (1 - 16)**

Used for routing an Input to an Output. Each of these buttons represents an Output. See page 13 for more information on routing DVI sources.

**3 Power Indicator**

This LED indicator will glow red when the power is turned on.

**4 LCD Display**

Displays the current routing status of the Matrix and is also used to manage source routing.

**5 Power**

Used to power ON and power OFF the matrix.

**6 IR Window**

Receives signals from the IR Remote Control unit.

**7 Input Buttons (1 - 16)**

Used for routing an Input to an Output. Each of these buttons represents an Input. See page 13 for more information on routing DVI sources.

# PANEL LAYOUT

## Back Panel

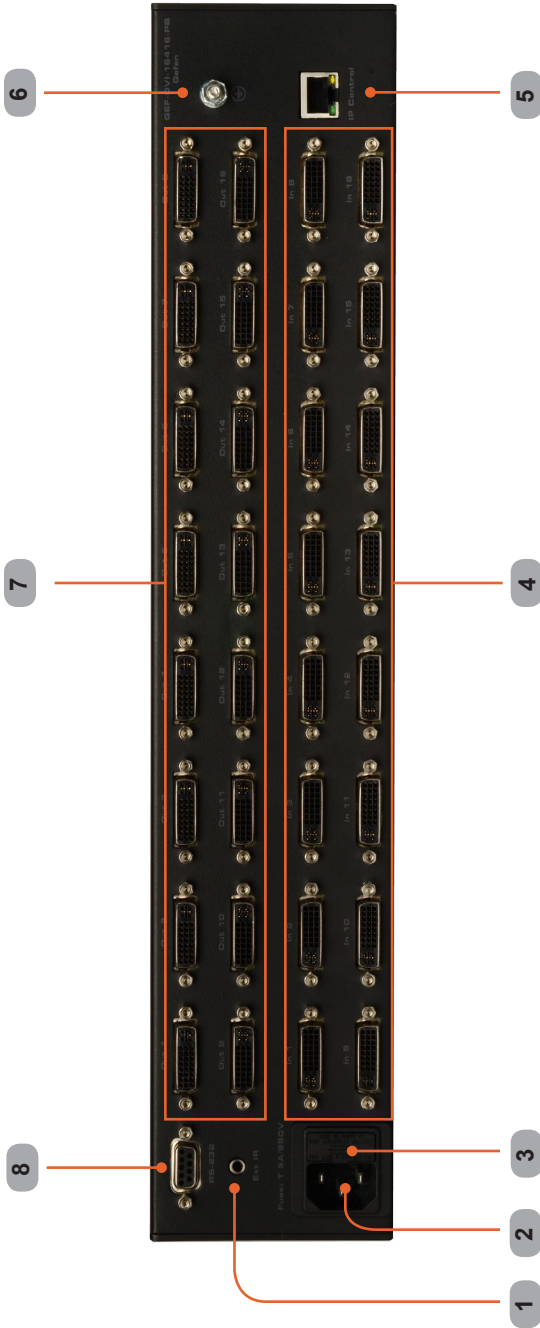

# PANEL DESCRIPTIONS

---

## Back Panel

- 1 IR Extender Port**  
Connect an optional IR extender to this port.
- 2 AC 110 / 220 V AC (50/60 Hz) Power Cable Receptacle**  
Connect the included AC power cord from this receptacle to an available electrical outlet.
- 3 Fuse Drawer**  
Each power receptacle houses a fuse drawer. Within each fuse drawer are two (2) 250 V fuses. One fuse is active and the other is a spare.
- 4 DVI Input Ports (1 - 16)**  
Connect DVI source devices to these ports.
- 5 IP Control Interface**  
Connect to this port to control the 16x16 DVI Matrix w/ Push Button Control using IP Control. See page 31 for more information on configuring IP settings.
- 6 Grounding Terminal**  
Provides a discharge path to ground in case a short circuit occurs between the “hot” lead of the power supply and the enclosure of the Matrix. The grounding wire should be attached from the grounding terminal to an approved ground path.
- 7 DVI Output Ports (1 - 16)**  
Connect DVI monitors to these ports.
- 8 RS-232 Serial Port**  
Connects to the RS-232 control device. The 16x16 DVI Matrix w/ Push Button Control may be switched remotely using this port. See page 30 for more information.

# IR REMOTE DESCRIPTION

RMT-16416IR  
Remote Control Unit

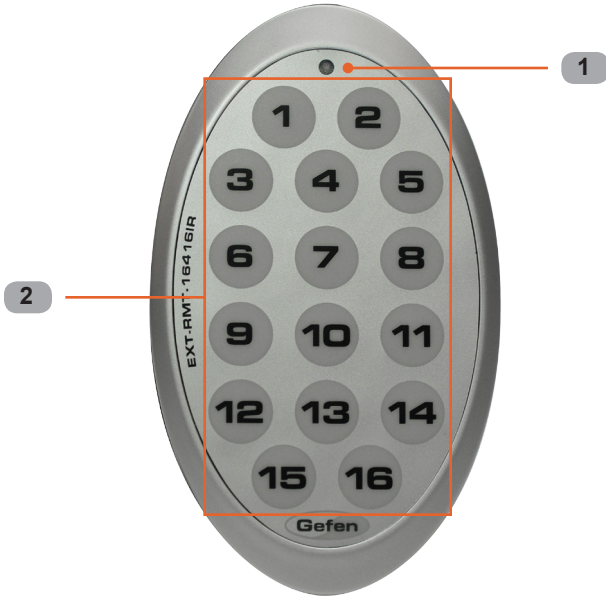

**1 Activity Indicator**

This LED will be activated momentarily each time a button is pressed.

**2 Display and Source Selection Buttons (1 - 16)**

These buttons are used to select which source is routed to a monitor.

**Routing Sources using the Remote Control unit**

Issuing a routing command is a two step process. The first step is to select the monitor (1-16) to which the source will be routed. The second step is to select the source (1-16).

*Example:*

*Route the source device connected to In 6 to the monitor connected to Out 4.*

1. Press button 4 (Out 4) on the IR remote control unit.
2. Press button 6 (In 6) on the IR remote control unit.

The source connected to In 6 will be routed to the monitor connected to Out 4.

# IR REMOTE INSTALLATION

---

## Installing the RMT-16416IR Battery

1. Remove the battery cover on the back of the IR Remote Control unit.
2. Insert the included battery into the open battery slot. The positive (+) side of the battery should be facing up.
3. Replace the battery cover.

The Remote Control unit ships with two batteries. One battery is required for operation and the other battery is a spare.



**Battery Slot**



**WARNING:** Risk of explosion if battery is replaced by an incorrect type. Dispose of used batteries according to the instructions.

# IR REMOTE CONFIGURATION

## How to Resolve IR Code Conflicts

In the event that IR commands from other remote controls interfere with the supplied IR Remote Control unit, changing the IR Remote Control's IR channel will fix the problem. The IR Remote Control unit has a bank of DIP switches used for setting the IR channel.

The DIP switch bank is located underneath the battery cover.



Remote Channel 0:  
Default



Remote Channel 1:



Remote Channel 2:



Remote Channel 3:



**Left:** Picture of the opened rear battery compartment of the IR remote showing the exposed DIP Switch bank between the battery chambers.

It is important that the IR channel on the Remote Control unit, matches the IR channel set on the 16x16 DVI Matrix w/ Push Button Control. For example, if both DIP switches on the IR Remote Control unit are set to IR channel 0 (both DIP switches down), then the 16x16 DVI Matrix w/ Push Button Control must also be set to IR channel 0. See page 54 on how to change the IR channel on the 16x16 DVI Matrix w/ Push Button Control.

# CONNECTING AND OPERATING THE 16X16 DVI MATRIX W/ PUSH BUTTON CONTROL

## How to Connect the 16x16 DVI Matrix w/ Push Button Control

1. Connect up to 16 DVI source devices to the DVI inputs on the rear panel of the 16x16 DVI Matrix w/ Push Button Control using the supplied DVI cables.
2. Connect up to 16 DVI displays to the DVI outputs on the rear panel of the 16x16 DVI Matrix w/ Push Button Control using DVI cables.
3. Connect the included AC power cable to the power receptacle on the rear panel of the 16x16 DVI Matrix w/ Push Button Control. Connect the opposite end of the cable into an available electrical outlet.

## Wiring Diagram

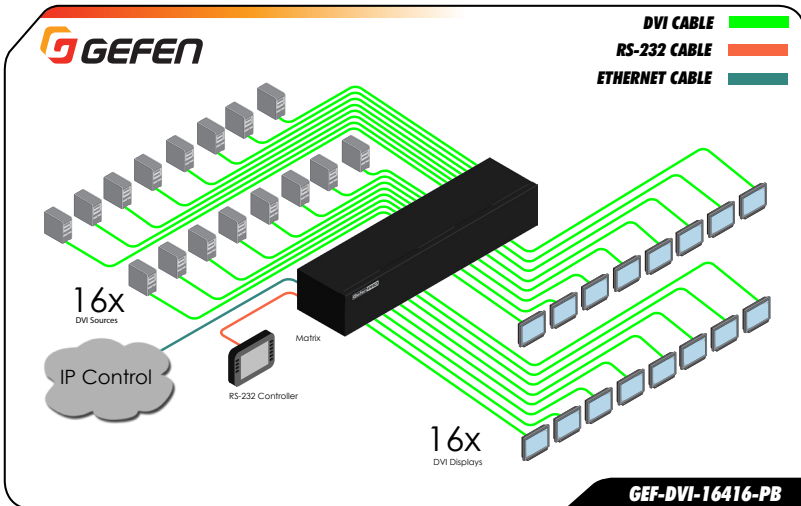

**ATTENTION:** This product should always be connected to a grounded electrical socket.

# FRONT PANEL DISPLAY

---

## Main Display

The **Main Display** of the 16x16 DVI Matrix w/ Push Button Control is a 16 character 2 line display. This display will show the Standby Screen and will also be used to aid in performing routing commands. When the unit is powered on, the following screen is displayed:



```
EDID LOADING
PLEASE WAIT
```

After a few moments, the *standby screen* is displayed. The *standby screen* is shown below:



```
GEFEN
16X16 DVI MATRIX
```

## Displaying Additional Information

Pressing the **Cancel** button, consecutively, will cycle through other screens such as firmware version and boot loader version:

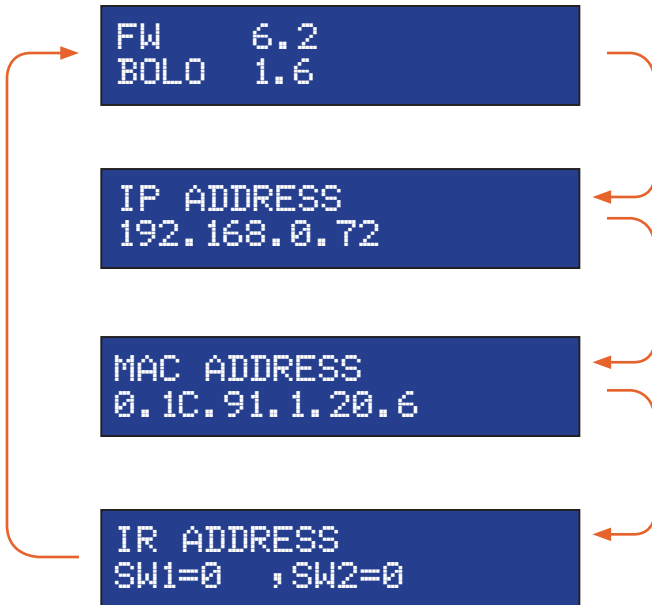



# ROUTING

## Routing Inputs to Outputs

The following example illustrates the routing process. An input may be routed to a single or multiple outputs. Multiple inputs cannot be routed to a single output. For this example, we will route Input 6 to the following outputs: Output 3, Output 6, Output 7, and Output 9.

1. Press the **Set** button on the front panel. Pressing the **Set** button tells the matrix that we want to perform a routing, masking, or preset operation. The **Set** button will glow bright blue, indicating that it has been pressed.



2. The front-panel display will indicate that routing mode is active.



3. First, we need to specify the outputs. Press buttons 3, 6, 7, and 9. The selected buttons will glow bright blue.



4. Select the desired input (source) button (1 - 16). For this example, we want to route the source connected to Input 6 to each of the outputs in step 3. Therefore, press button 6 on the bottom row. The selected input will glow bright blue.



**NOTE:** Only one input can be routed at a time. If the wrong input button is accidentally pressed, then continue by pressing the correct input button. The previous input button will automatically be deselected.

# ROUTING



5. Press the **Set** button on the front panel, again, to complete the routing operation.  
The front panel display will indicate that the routing process has been completed.



6. After a few moments, the selected buttons on the front panel will turn off and the matrix will return to the *standby screen*.

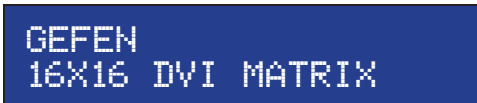

## Getting the Current Routing Status of an Input

To display the current routing status of an input, press the desired input button on the front panel of the matrix. Once the input button is pressed, the routed outputs will be displayed.

From our previous routing example, we already know that Input 6 is routed to Output 3, 6, 7, and 9. Let's use this to illustrate how to retrieve the current routing status of an input.

(continued on next page)

# ROUTING

1. Press the button for Input 6 on the matrix.
2. The current routing status for Input 6 will be displayed by the front panel buttons:



3. After a few moments the buttons will automatically turn off.

To immediately dismiss the routing status and return to the *standby screen*, press the **Cancel** button.

## Getting the Current Routing Status of an Output

To display the current routing status of an output, press the desired output button on the front panel of the matrix. Once the output button is pressed, the associated input will be displayed. We'll continue with the previous example.

1. Press the button for Output 3 on the matrix.
2. The current routing status for Output 3 will be displayed by the front panel buttons:



3. After a few moments the buttons will automatically turn off.

To immediately dismiss the routing status and return to the *standby screen*, press the **Cancel** button.

## One-to-One Routing

When an input-output pair share the same number, it is called “one-to-one” routing. By default, the 16x16 DVI Matrix w/ Push Button Control is shipped in “one-to-one” mode. This means that Input 1 is routed to Output 1, Input 2 is routed to Output 2, and so on.

# PRESETS

## Saving the Current Routing State

The 16x16 DVI Matrix w/ Push Button Control allows routing (and masking) states to be saved to internal non-volatile memory. Each routing state can be recalled at a later time (see Recalling a Saved Routing State). Even if the matrix is powered OFF, the presets will be retained in memory.

We'll illustrate an example by saving the routing state of Input 6, which we created on page 13.

1. Press the **PreSet** button, *twice*. The **PreSet** button will glow bright blue, indicating that it has been pressed. The front-panel display will indicate that the matrix is in "save preset" mode:



2. Select a preset memory location by pressing any of the first eight input buttons (1 - 8). The matrix supports up to eight preset locations. For this example, press the button 1.



3. Press the **Set** button to store the preset.



(continued on next page)

## PRESETS

---

- The **Set** button will flash momentarily and the front-panel display will indicate that the preset has been saved.



PRESET MODE  
COMPLETE

- After a few moments, the front-panel display will display the *standby screen*.



GEFEN  
16X16 DVI MATRIX

# PRESETS

## Recalling a Saved Routing State

The 16x16 DVI Matrix w/ Push Button Control allows saved routing (and masking) states to be recalled from memory for instant access. In this example, we will recall the routing preset that we stored in the previous example. In order to clearly see how this process works, try changing the routing state of Input 6 to Output 2. Then, use the steps below to recall the original routing state.

1. Press the **PreSet** button, *once*. The **PreSet** button will glow bright blue, indicating that it has been pressed. The front-panel display will indicate that the matrix is in “recall preset” mode:



2. Since we stored our preset in Preset 1, press the button for Input 1 to recall the routing state.



3. Press the **Set** button to recall the routing state from the selected location.

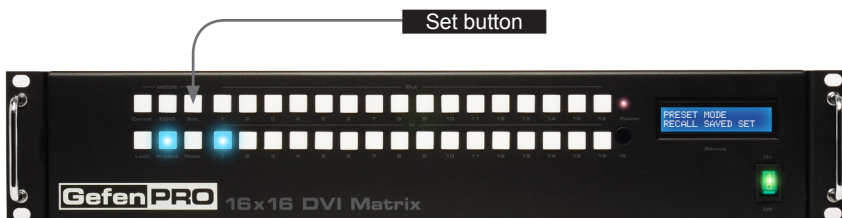

## PRESETS

---

- The **Set** button will flash momentarily and the front-panel display will indicate that the preset has been recalled.



PRESET MODE  
COMPLETE

- After a few moments, the front-panel display will display the *standby screen*.



GEFEN  
16X16 DVI MATRIX

# MASKING

## Masking Outputs

“Masking” prevents the output device (display, etc) from receiving an output signal. Instead of powering-down or disconnecting the output device, individual or multiple outputs can be masked. Inputs cannot be masked.

To illustrate masking, we'll use our original routing example from the section [Routing Inputs to Outputs](#).

1. Press the **Mask** button. The Mask button will glow bright blue and the front-panel display will indicate that the matrix is in mask mode.



2. Select the desired outputs to be masked. In this example, we will select Output 5 and Output 6. Each output button will glow bright blue as they are pressed.



3. Press the **Set** button to mask the selected outputs. The **Set** button will flash momentarily.

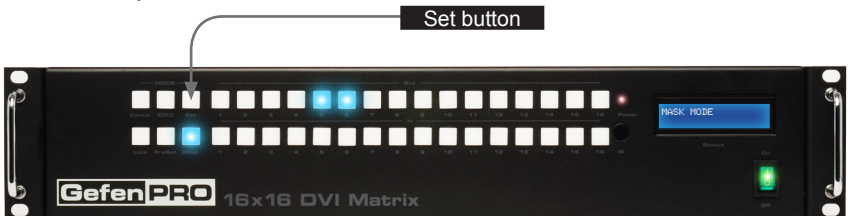

(continued on next page)



## MASKING

---

- Once the **Set** button is pressed, the front-panel display will indicate that the masking process was successful:



- After a few moments, the selected buttons will turn off and the front-panel display will return to the *status screen*.

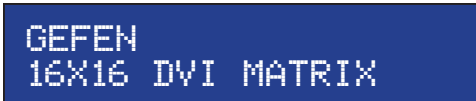

# MASKING

## Getting the Current Masking Status

If the masking state is unknown, it can be queried using the **Mask** button. Alternatively, the masking state can be retrieved through the Web Interface or by using the `m` command.

1. Press the **Mask** button. The Mask button will glow bright blue and the front-panel display will indicate that the matrix is in mask mode.

If any outputs are currently masked, they will be indicated on the front panel. For example, since we recently masked Output 5 and Output 6, these buttons will glow bright blue, as shown below.



2. After a few moments, the selected buttons will turn off and the front-panel display will return to the *standby screen*.

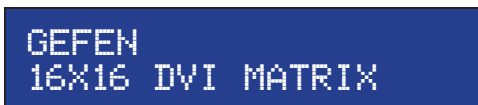

# MODE BUTTONS

## Unmasking Outputs

Once an output (or multiple outputs) has been masked, it can be unmasked. Unmasking an output will allow the video signal to be displayed after a masking operation.

We'll continue with our previous example and unmask Output 5 and Output 6.

1. Press the **Mask** button. The **Mask** button will glow bright blue and the front-panel display will indicate that the matrix is in mask mode.

Once the mask button is pressed, any outputs that have been masked will be indicated on the front panel.



2. Press the desired output button(s) to unmask the output. In our case, we will select both Output 5 and Output 6. Each button will turn off as it is pressed.



3. Press the **Set** button. The **Set** button will flash momentarily.

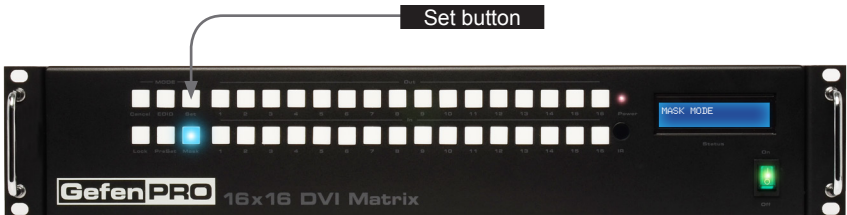

## MODE BUTTONS

---

- Once the **Set** button is pressed, the front-panel display will indicate that the unmasking process was successful:



- After a few moments, the matrix will return to the *standby screen*.

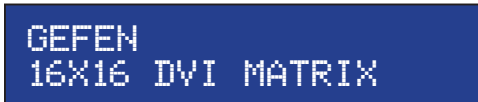

## LOCKING THE MATRIX

---

Locking the matrix will prevent any changes by disabling all buttons (except the **Lock** button) on the front panel. This feature is useful in preventing routing or other changes caused by accidentally pressing the buttons on the front panel.

1. Press the **Lock** button. The **Lock** button will glow bright blue, indicating that the matrix is now locked. The front-panel display will also indicate that the matrix has been locked.



2. To unlock the matrix, press the **Lock** button again. The **Lock** button will turn off and the front-panel display will return to the *standby screen*.

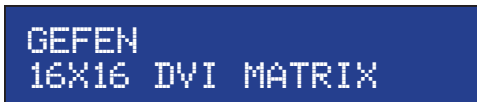

# EDID MANAGEMENT

The 16x16 DVI Matrix w/ Push Button Control incorporates EDID management support. Basic EDID functions, such as storing EDID data to inputs can be performed using the buttons on the front panel. Advanced EDID management features are controlled through the Web interface or by using EDID Management commands.

## Saving the Downstream EDID to an Input

1. Press the **EDID** button, *once*. The **EDID** button will glow bright blue and the front-panel display will indicate that the matrix is ready to copy the downstream EDID.



DSTOLO is an abbreviation for "DownStream TO LOcal".

2. Press the desired output. For this example, we are going to use the EDID of the display that is connected to Output 7. Therefore, we will press the button for Output 7.



(continued on next page)

## EDID MANAGEMENT

3. Select the desired input where the EDID will be stored. We will arbitrarily select Input 4, by pressing button **4**.



4. Press the **Set** button. The **Set** button will flash momentarily.

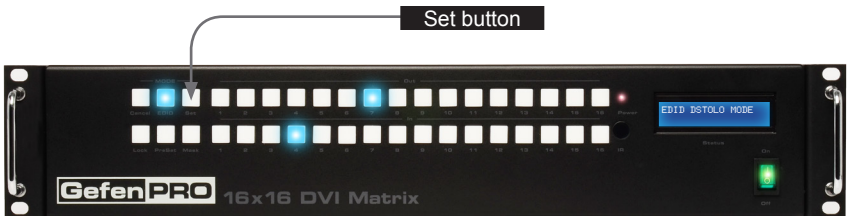

5. Once the **Set** button is pressed, the matrix will begin copying the downstream EDID from the display (or other sink) to the EDID from the selected output to the specified input.

The front-panel display will indicate that the matrix is copying the EDID:

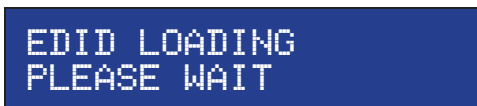

6. After the EDID has been successfully copied to the selected input, the front-panel display will show the following message:



# EDID MANAGEMENT

## Saving the Default EDID to an Input

There may be instances when the downstream EDID data is corrupt or the EDID is not being read correctly by the matrix. On the other hand, it may be desirable to use a “generic” EDID as opposed to the downstream EDID. In any case, the matrix provides a default (internal) EDID that can be used. Let’s look at an example.

1. Press the **EDID** button, *twice*. The EDID button will glow bright blue and the front-panel display will indicate that the matrix is ready to copy the default EDID to the specified input.



DETOLO is an abbreviation for “DEfault TO LOcal”.

2. Select the input where the default EDID will be copied. For this example, we will copy the default EDID to Input 5. Therefore, we will press the button for Input 5.



(continued on next page)



## EDID MANAGEMENT

3. Press the **Set** button. The Set button will flash momentarily.

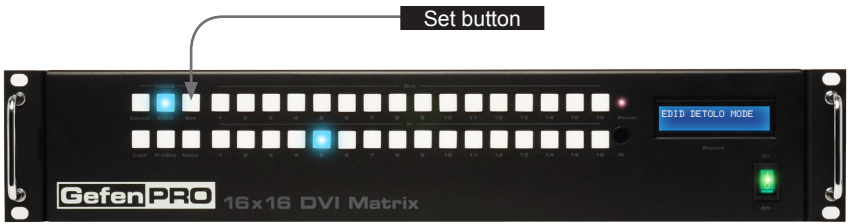

4. Once the **Set** button is pressed, the matrix will begin copying the default EDID to the specified input.

The front-panel display will indicate that the matrix is copying the EDID:

```
EDID LOADING  
PLEASE WAIT
```

5. After the EDID has been successfully copied to the selected input, the front-panel display will show the following message:

```
EDID LOADING  
COPY COMPLETE
```

6. After a few moments, the selected buttons will turn off and the front-panel display will return to the *status screen*.

```
GEFEN  
16X16 DVI MATRIX
```

# RS-232 / IP CONTROL

## RS-232 Interface

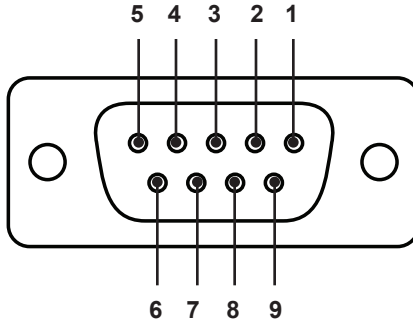

RS-232 Controller

Matrix

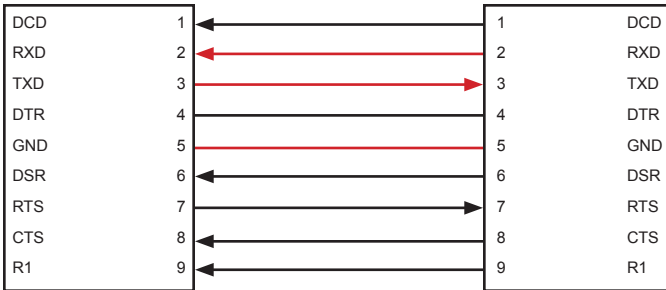

Only TXD, RXD, and GND are used.

## RS232 Settings

Baud rate .....19200  
 Data bits ..... 8  
 Parity bits ..... None  
 Stop bits .....1  
 Flow Control ..... None



**IMPORTANT:** When sending RS-232 commands, a carriage return must be included at the end of the command. A space *must* be included between the command and the parameter.

## Using Syner-G

When using this product for the first time, it is recommended that the unit be configured using the Gefen Syner-G™ Software Suite. The Gefen Syner-G™ Software Suite is free software that is available from the Gefen Web site.

1. Download and install the Gefen Syner-G™ Software Suite. Download the application here: <http://www.gefen.com/synerg/>
2. Connect an Ethernet cable from the network to the **IP control** port on the product.
3. Launch the Gefen Syner-G™ Software Suite.
4. Click the GEF-DVI-16416-PB from the product list.

Select Function

Discover and Configure IP
Manage a Product
EDID Editor

| My PC            | 10.5.64.90   | 00:1D:09:7E:E1:1F | Local Area Connect   |
|------------------|--------------|-------------------|----------------------|
| Product Name     | IP Address   | MAC Address       | Description          |
| EXT-CU-LAN       | 10.5.64.138  | 00:1C:91:04:60:75 | EXT-CU-LAN RD MASTER |
| EXT-HDKVM-LAN-S  | 10.5.64.67   | 02:1D:00:5A:8D:53 | EXT-DVIKVM-LAN-L-S   |
| EXT-CU-LAN       | 10.5.64.146  | 00:1C:91:04:60:17 | Dev CU-FAN Nick Desk |
| EXT-CU-LAN       | 10.5.64.130  | 00:1C:91:04:60:5D | EXT-CU-LAN RDSLAVE   |
| GEF-DVI-16416-PB | 192.168.1.72 | 00:1C:91:04:80:14 | 16x16 DVI Matrix     |

Device Settings

|              |                   |                  |                  |
|--------------|-------------------|------------------|------------------|
| Product Name | GEF-DVI-16416-PB  | IP Mode          | Static           |
| MAC Address  | 00:1C:91:04:80:14 | Web GUI Port     | 80               |
| IP Address   | 192.168.1.72      | Telnet Port      | 23               |
| Subnet Mask  | 255.255.255.0     | Firmware Version | v1.0             |
| Gateway IP   | 192.168.1.1       | Hardware Version | v1.0             |
| DNS          |                   | Description      | 16x16 DVI Matrix |

## RS-232 / IP CONTROL

- Under the Device Settings section, enter the desired IP address, subnet mask, gateway IP address, Web GUI port, and Telnet port in the supplied fields.

The screenshot displays the 'Device Settings' configuration page. It features a grid of input fields and buttons. The 'IP Address' field is highlighted with a red border. Below the main settings area, there are three buttons: 'Reboot', 'Show Me', and 'Save'. There are also two blue links: 'Web GUI' and 'Web Page'.

If desired, the **Description** field can be changed as well. This is useful to identify if you have multiple units running on a network.

- Click the **Save** button at the bottom right-corner of the screen.
- Click the **Reboot** button.
- Click the **Web GUI** link, above the **Reboot** button, to access the built-in web interface.

The following table lists the default IP settings for this product.

| Description | Address / Port | Description | Address / Port |
|-------------|----------------|-------------|----------------|
| IP Address  | 192.168.1.72   | Gateway     | 192.168.1.1    |
| Subnet      | 255.255.255.0  | HTTP Port   | 80             |

## EDID Management

| Command              | Description  |
|----------------------|--|
| <i>#dynamic_edid</i> | Enables / disables dynamic EDID                      |
| <i>#edidbatolo</i>   | Read downstream EDID and stores in any Local Input   |
| <i>#ediddetolo</i>   | Sets Local EDID to Default EDID                      |
| <i>#ediddstoba</i>   | Read downstream EDID and stores in EDID Bank         |
| <i>#ediddstolo</i>   | Read downstream EDID and stores into a Local EDID    |
| <i>#lock_edid</i>    | Secures Local EDID                                   |
| <i>#prbaedid</i>     | Read EDID from an EDID bank and sends to serial port |
| <i>#prdsedid</i>     | Read downstream EDID and sends to serial port        |
| <i>#predidst</i>     | Prints EDID details                                  |
| <i>#prloedid</i>     | Read Input Local EDID and sends to serial port       |

### #dynamic\_edid Command

The *#dynamic\_edid* command provides the ability to route any downstream EDID to any input. When enabled, the EDID is copied to all inputs from the last selected active output. When disabled, the EDID is copied to all inputs from the first active display detected, starting from Output 1.

#### Syntax:

*#dynamic\_edid* param1

#### Parameters:

*param1*

Value

[0 ... 1]

| Value | Meaning |
|-------|---------|
| 0     | Disable |
| 1     | Enable  |

#### Default:

Disabled

### #edidbatolo Command

The #edidbatolo command reads the downstream EDID and stores it to any local input.

#### Syntax:

```
#edidbatolo param1 param2 [param3...param9]
```

#### Parameters:

|               |                  |            |
|---------------|------------------|------------|
| <i>param1</i> | EDID bank offset | [1 ... 5]  |
| <i>param2</i> | Input            | [1 ... 16] |

#### Notes:

If *param2* = 0, then the EDID in the specified bank is copied to all eight inputs.

### #ediddetolo Command

The #ediddetolo command stores the Default EDID (640x480) in the specified Local EDID inputs.

#### Syntax:

```
#ediddetolo param1 param2 param3...param9
```

#### Parameters:

|               |       |            |
|---------------|-------|------------|
| <i>param1</i> | Input | [1 ... 16] |
|---------------|-------|------------|

#### Notes:

If *param1* = 0, then all 16 DVI inputs will be set to the Default EDID.

### #ediddstoba Command

The #ediddstoba command reads the downstream EDID and stores it to a specified EDID bank.

#### Syntax:

```
#ediddstoba param1 param2
```

#### Parameters:

|               |                      |            |
|---------------|----------------------|------------|
| <i>param1</i> | A downstream monitor | [1 ... 16] |
| <i>param2</i> | EDID bank offset     | [1 ... 3]  |

### #ediddstolo Command

The #ediddstolo command reads the downstream EDID and stores it to a Local EDID input.

#### Syntax:

```
#ediddstolo param1 param2 [param3...param9]
```

#### Parameters:

|               |                      |            |
|---------------|----------------------|------------|
| <i>param1</i> | A downstream monitor | [1 ... 16] |
| <i>param2</i> | Input list           | [1 ... 16] |

#### Notes:

If *param2* = 0, then the downstream EDID is stored to all 16 DVI inputs. If more than eight inputs need to be specified in order to receive the downstream EDID, the #ediddstolo command must be executed twice.

#### Example:

```
#ediddstolo 2 1 2 3 4 5 6 7 8 9 10 11 (not permitted!)
```

Instead, run the function twice:

```
#ediddstolo 2 1 2 3 4 5 6 7 8
```

```
#ediddstolo 2 9 10 11
```

## #lock\_edid Command

The #lock\_edid command secures the Local EDID and disables the automatic loading of the downstream EDID after the matrix is powered on. This feature can also be controlled using the Web Interface (see page 69).

### Syntax:

```
#lock_edid param1
```

### Parameters:

*param1* Input [0 ... 1]

| Value | Meaning |
|-------|---------|
| 0     | Disable |
| 1     | Enable  |

## #prbaedid Command

The #prbaedid command reads the EDID file from the specified bank and sends it to the serial port.

### Syntax:

```
#prbaedid param1
```

### Parameters:

*param1* EDID bank [1 ... 3]

## #prdsedid Command

The #prdsedid command reads the downstream EDID and sends it to the serial port.

### Syntax:

```
#prdsedid param1
```

### Parameters:

*param1* A downstream monitor [1 ... 16]



### **#predidst Command**

The #predidst command reads the downstream EDID. This command displays a table containing details relating to the Local EDID and the monitor name.

Syntax:

#predidst

Parameters:

None

### **#prloedid Command**

The #prloedid command reads the local EDID of a specified input and spools it to the serial port.

Syntax:

#prloedid param1

Parameters:

*param1*

Input

[1 ... 16]

### IP Configuration

| Command                    | Description   |
|----------------------------|---|
| <i>#ipconfig</i>           | Displays all TCP/IP settings                        |
| <i>#resetip</i>            | Resets IP configuration to factory settings         |
| <i>#set_http_port</i>      | Sets the Web server listening port                  |
| <i>#set_tcp_term_pass</i>  | Sets the TCP terminal password                      |
| <i>#set_tcp_term_port</i>  | Sets the Telnet listening port                      |
| <i>#set_udp_port</i>       | Sets the local UDP listening port                   |
| <i>#set_udp_rip</i>        | Sets the remote UDP IP address                      |
| <i>#set_udp_rport</i>      | Sets the remote UDP port                            |
| <i>#sgateway</i>           | Sets the IP gateway address                         |
| <i>#show_tcp_term_pass</i> | Displays the current TCP password for login         |
| <i>#sipadd</i>             | Sets the IP address of the matrix                   |
| <i>#snetmask</i>           | Sets the IP network mask                            |
| <i>#use_tcp_term_pass</i>  | Enables / disables password prompt for TCP sessions |
| <i>#use_udp_access</i>     | Enables / disables UDP listening                    |

### **#ipconfig Command**

The #ipconfig command displays all TCP/IP settings on the matrix.

Syntax:

```
#ipconfig
```

Parameters:

None

Example:

```
#ipconfig

----- TCP/IP settings -----

MAC add   = 00:1C:91:01:01:01
IP add    = 192.168.1.72
Net Mask  = 255.255.255.0
Gateway   = 192.168.1.254
Web Server Port = 80
TCP Terminal Server Port = 23
TCP Terminal password at login is set to ON
UDP Server Port = 25665
UDP Remote IP = 110.0.255.255
UDP Remote Port = 26989
UDP Access = Disabled
```

### **#resetip Command**

The #resetip command resets all TCP/IP settings to factory defaults.

Syntax:

```
#resetip
```

Parameters:

None

Notes:

The matrix must be rebooted after executing this command.

### **#set\_http\_port Command**

The #set\_http\_port command sets the Web server listening port. The default port is 80.

#### Syntax:

```
#set_http_port param1
```

#### Parameters:

|               |      |               |
|---------------|------|---------------|
| <i>param1</i> | Port | [0 ... 65535] |
|---------------|------|---------------|

#### Notes:

The matrix must be rebooted after executing this command.

### **#set\_tcp\_term\_pass Command**

The #set\_tcp\_term\_pass command sets the TCP password. The maximum length of the password is 20 characters and is case-sensitive. The default password is *Admin*.

#### Syntax:

```
#set_tcp_term_pass param1
```

#### Parameters:

|               |                        |
|---------------|------------------------|
| <i>param1</i> | Current password       |
| <i>param2</i> | New password           |
| <i>param3</i> | New password (confirm) |

#### Notes:

The matrix must be rebooted after executing this command.

#### Example:

```
#set_tcp_term_pass Admin reindeer reindeer  
TCP Terminal password updated to: reindeer
```



### **#set\_udp\_rip Command**

The #set\_udp\_rip command sets the remote UDP IP address. The default port value is 8.

#### Syntax:

```
#set_udp_rip param1
```

#### Parameters:

*param1* IP Address

#### Notes:

The matrix must be rebooted after executing this command.

#### Example:

```
#set_udp_rip 192.168.1.20
```

New remote UDP IP address set to: 192.168.1.20

### **#set\_udp\_rport Command**

The #set\_udp\_rport command sets the remote UDP port.

#### Syntax:

```
#set_udp_rport param1
```

#### Parameters:

*param1* Port

#### Notes:

The matrix must be rebooted after executing this command.

#### Syntax:

```
#set_udp_rport 4096
```

New remote UDP port set to: 4096







### #use\_tcp\_term\_pass Command

The #use\_tcp\_term\_pass command enables / disables the password prompt at the beginning of a session. The default setting is *disabled*. This feature can also be enabled or disabled through the Web GUI (see page 71).

#### Syntax:

```
#use_tcp_term_pass param1
```

#### Parameters:

*param1*

State

[0 ... 1]

| Value | Meaning                 |
|-------|-------------------------|
| 0     | Disable password        |
| 1     | Enable (force) password |

#### Example:

```
#use_tcp_term_pass 1
```

TCP Terminal password at login is set to ON

### **#use\_udp\_access Command**

The #use\_udp\_access command enables / disables UDP listening.

#### **Syntax:**

```
#use_udp_access param1
```

#### **Parameters:**

*param1*

State

[0 ... 1]

| Value | Meaning                 |
|-------|-------------------------|
| 0     | Disable password        |
| 1     | Enable (force) password |

#### **Example:**

```
#use_udp_access 1
```

UDP access is set to ON





## r Command

The r command routes the specified input to the specified outputs.

### Syntax:

```
r param1 param2[...param17]
```

### Parameters:

|               |         |            |
|---------------|---------|------------|
| <i>param1</i> | Input   | [1 ... 16] |
| <i>param2</i> | Outputs | [1 ... 16] |

### Notes:

If *param2* = 0, then the specified input is routed to all outputs.

### Examples:

```
r 7 3 4 5 6 10 12
```

Input 7 is routed to outputs: 3 4 5 6 10 12

```
r 2 0
```

All outputs are routed to Input 2

## s Command

The s command routes the specified input to all outputs.

### Syntax:

```
s param1
```

### Parameters:

|               |       |            |
|---------------|-------|------------|
| <i>param1</i> | Input | [1 ... 16] |
|---------------|-------|------------|

### Example:

```
s 1
```

All outputs are routed to Input 1

## Masking

| Command                 | Description                          |
|-------------------------|--------------------------------------|
| <code>#maskout</code>   | Masks the selected (video) output(s) |
| <code>#unmaskout</code> | Unmasks the selected output(s)       |

### #maskout Command

The `#maskout` command allows blanking of the specified outputs.

#### Syntax:

```
#maskout param1 param2
```

#### Parameters:

`param1` Output [1 ... 16]

`param2` State [0 ... 1]

| Value | Meaning |
|-------|---------|
| 0     | Unmask  |
| 1     | Mask    |

#### Notes:

*If `param1 = 0`, then all outputs will be masked.*

The current masking state will be lost if power is interrupted or if the masking state is not saved (see `#savepreset` on page 48).

### **#unmaskout Command**

The #unmaskout command unmask the specified outputs.

#### Syntax:

```
#unmaskout param1...param8
```

#### Parameters:

|               |        |            |
|---------------|--------|------------|
| <i>param1</i> | Output | [1 ... 16] |
|---------------|--------|------------|

#### Notes:

If *param1* = 0, then all outputs will be unmasked.

#### Examples:

```
#unmaskout 3 8 10  
Activate outputs: 3 8 10
```

```
#unmaskout 0  
Activate all outputs
```

## Miscellaneous

| Command                 | Description   |
|-------------------------|---|
| <i>#fadefault</i>       | Resets the matrix to factory default routing        |
| <i>#help</i>            | Displays all available commands                     |
| <i>#lock_fo</i>         | Toggles the +5V lock power state                    |
| <i>#set_input_name</i>  | Specifies a name for an input                       |
| <i>#set_ir</i>          | Sets the IR channel of the matrix                   |
| <i>#set_output_name</i> | Specifies a name for an output                      |
| <i>#show_temp</i>       | Displays the board temperatures                     |
| <i>#show_user_name</i>  | Displays the TCP user name                          |
| <i>#show_ver_data</i>   | Displays the current hardware                       |
| <i>#show_voltage</i>    | Displays the board voltages                         |
| <i>f</i>                | Toggles / displays +5V input                        |
| <i>m</i>                | Displays the current routing status in tabular form |

### **#fadefault Command**

The *#fadefault* command disables the EDID lock state, sets the default routing state (1-1, 2-2, 3-3, etc.) and resets the input and output names to the default names (e.g. Output 1, Input 1).

#### Syntax:

*#fadefault*

#### Parameters:

*None*





### #set\_input\_name Command

The #set\_input\_name command provides a name to the selected input. For example, "Input 1" could be renamed as "Computer 1". The maximum string length for *param2* is 15 characters. Special characters and spaces are not permitted. If required, use the underscore character ("\_") to separate characters.

#### Syntax:

```
#set_input_name param1 param2
```

#### Parameters:

|               |       |            |
|---------------|-------|------------|
| <i>param1</i> | Input | [1 ... 16] |
| <i>param2</i> | Name  |            |

#### Example:

```
#set_input_name 5 computer1  
computer1 is assigned to input 5
```

### #set\_ir Command

The #set\_ir set the IR channel for the matrix. The associated DIP switch settings for the IR remote control unit are returned. See page 10 for details on setting the IR channel for the IR remote control.

#### Syntax:

```
#set_ir param1
```

#### Parameters:

|               |         |           |
|---------------|---------|-----------|
| <i>param1</i> | Channel | [0 ... 3] |
|---------------|---------|-----------|

#### Example:

```
#set_ir 2  
RMT_IR - SW1=0, SW2=1
```

### **#set\_output\_name Command**

The #set\_output\_name command provides a name to the selected output. For example, "Output 1" could be renamed as "HDDisplay". The maximum string length for *param2* is 15 characters. Special characters and spaces are not permitted. If required, use the underscore character ("\_") to separate characters.

#### Syntax:

```
#set_output_name param1 param2
```

#### Parameters:

|               |        |            |
|---------------|--------|------------|
| <i>param1</i> | Output | [1 ... 16] |
| <i>param2</i> | Name   |            |

#### Example:

```
#set_output_name 3 display_3  
display_3 is assigned to output 3
```

### **#show\_temp Command**

The #show\_temp command displays the board temperatures to the screen.

#### Syntax:

```
#show_temp
```

#### Parameters:

None

#### Example:

```
#show_temp  
Temperature near cross point top side is 50  
Temperature near cross point bottom side is 44 C degree  
Temperature on input board is 43 C degree
```

### **#show\_user\_name Command**

The #show\_user\_name command displays the current TCP terminal user name.

#### **Syntax:**

```
#show_user_name
```

#### **Parameters:**

None

#### **Example:**

```
#show_user_name  
TCP Terminal login: Administrator
```

### **#show\_ver\_data Command**

The #show\_ver\_data command displays the hardware and firmware version of the screen.

#### **Syntax:**

```
#show_ver_data
```

#### **Parameters:**

None

#### **Example:**

```
#show_ver_data  
Hardware version 2  
Firmware Release version 6.2  
Release date: Jan 21 2013  
Release time: 16:38:56  
Boot loader version 1.6
```

### **#show\_voltage Command**

The #show\_voltage command displays board voltages to the screen.

#### Syntax:

```
#show_voltage
```

#### Parameters:

*None*

#### Example:

```
#show_voltage
```

```
Analog voltage 3.3 , measured 3262 mV
```

```
Analog voltage 1.8 , measured 1781 mV
```

```
Analog voltage 1.2 , measured 1180 mV
```

## f Command

The `f` command enables / disables the +5V on the specified input. Do not precede this command with the “#” symbol.



**WARNING:** Use caution when applying power to inputs. If the source device supplies +5V on the input, then enabling the +5V may cause damage to the source and/or the 16x16 DVI Matrix w/ Push Button Control.

### Syntax:

```
f param1 param2
```

### Parameters:

*param1* Input [1 ... 16]  
*param2* State [0 ... 1]

| Value | Meaning |
|-------|---------|
| 0     | Disable |
| 1     | Enable  |

### Notes:

If *param1* = 0, then all inputs will be affected.

### Examples:

```
f 15 1  
Enable F0 15
```

```
f 0 1  
Enable All FO
```

## m Command

The m command displays the routing status in tabular form. Do not precede this command with the “#” symbol.

### Syntax:

m

### Parameters:

None

### Example:

m

| Output    | Input   | HPD | Status |
|-----------|---------|-----|--------|
| Output_1  | Input_1 | LOW | ACTIVE |
| Output_2  | Input_1 | LOW | ACTIVE |
| Output_3  | Input_1 | LOW | ACTIVE |
| Output_4  | Input_1 | LOW | ACTIVE |
| Output_5  | Input_1 | LOW | ACTIVE |
| Output_6  | Input_1 | LOW | ACTIVE |
| Output_7  | Input_1 | LOW | ACTIVE |
| Output_8  | Input_1 | LOW | ACTIVE |
| Output_9  | Input_1 | LOW | ACTIVE |
| Output_10 | Input_1 | LOW | ACTIVE |
| Output_11 | Input_1 | LOW | ACTIVE |
| Output_12 | Input_1 | LOW | ACTIVE |
| Output_13 | Input_1 | LOW | ACTIVE |
| Output_14 | Input_1 | LOW | ACTIVE |
| Output_15 | Input_1 | LOW | ACTIVE |
| Output_16 | Input_1 | LOW | ACTIVE |

GEFEN PRO

Dynamic EDID mode

RMT\_IR - SW1=0,SW2=0

# WEB INTERFACE

## View Matrix Status

### Matrix Status

Displays the current routing status of each input and output on the matrix.

The screenshot shows the 'Gefen 16x16 DVI Manager' web interface. At the top, there are navigation tabs: 'VIEW MATRIX STATUS', 'MANAGE EDID', 'MASKING', 'IP CONFIGURATION', 'BACKUP/RESTORE', and 'POWER MANAGEMENT'. The 'VIEW MATRIX STATUS' tab is active. Below the tabs is a 'Matrix Status' table with columns for 'Output', 'Input', and 'Status'. The table lists 16 rows, each with 'Output\_X', 'Input\_1', and 'Active'. To the right of the table are various control elements, including a 'Refresh' button and an 'Auto Refresh' checkbox. A large orange box highlights the table and the 'Refresh' and 'Auto Refresh' controls. An orange arrow points from the 'Refresh' button to the 'Refresh' text below. Another orange arrow points from the 'Auto Refresh' checkbox to the 'Auto Refresh' text below. A third orange arrow points from the 'Matrix Status' title to the 'Matrix Status' text below.

| Output    | Input   | Status |
|-----------|---------|--------|
| Output_1  | Input_1 | Active |
| Output_2  | Input_1 | Active |
| Output_3  | Input_1 | Active |
| Output_4  | Input_1 | Active |
| Output_5  | Input_1 | Active |
| Output_6  | Input_1 | Active |
| Output_7  | Input_1 | Active |
| Output_8  | Input_1 | Active |
| Output_9  | Input_1 | Active |
| Output_10 | Input_1 | Active |
| Output_11 | Input_1 | Active |
| Output_12 | Input_1 | Active |
| Output_13 | Input_1 | Active |
| Output_14 | Input_1 | Active |
| Output_15 | Input_1 | Active |
| Output_16 | Input_1 | Active |

### Refresh

Click to refresh the Matrix Status screen

### Auto Refresh

Check this box to enable Auto Refresh. The Auto Refresh function automatically refreshes the interface every 10 seconds.



## Dynamic EDID Mode

Routes any downstream EDID to any input. See the #dynamic\_edid command on page 33 for details on this feature. Options: On, Off. Click the Update Dynamic EDID State button after selecting either On or Off.

The screenshot shows a web interface with two main sections highlighted by orange boxes. The top section, titled "Dynamic EDID Mode", contains a button labeled "Update Dynamic EDID State" and two radio buttons for "Off" and "On", with "On" selected. Below this is a "Matrix Status" table and a "Switch Outputs" section. The "Switch Outputs" section has a sub-section for "Outputs" with checkboxes for Output\_1 through Output\_15, and a sub-section for "Inputs" with radio buttons for Input\_1 through Input\_16. A "Switch" button is located at the bottom of the "Switch Outputs" section. The bottom section, also titled "Switch Outputs", provides a larger view of the "Outputs" and "Inputs" controls, with checkboxes for Output\_1, Output\_7, Output\_13, Output\_2, Output\_8, Output\_14, Output\_3, Output\_9, Output\_15, and radio buttons for Input\_1, Input\_7, Input\_13, Input\_2, Input\_8, Input\_14, Input\_3, Input\_9, Input\_15, and Input\_16. A "Switch" button is also present at the bottom of this section.

| Output    | Input   | Status |
|-----------|---------|--------|
| Output_1  | Input_1 | Active |
| Output_2  | Input_1 | Active |
| Output_3  | Input_1 | Active |
| Output_4  | Input_1 | Active |
| Output_5  | Input_1 | Active |
| Output_6  | Input_1 | Active |
| Output_7  | Input_1 | Active |
| Output_8  | Input_1 | Active |
| Output_9  | Input_1 | Active |
| Output_10 | Input_1 | Active |
| Output_11 | Input_1 | Active |
| Output_12 | Input_1 | Active |
| Output_13 | Input_1 | Active |
| Output_14 | Input_1 | Active |
| Output_15 | Input_1 | Active |
| Output_16 | Input_1 | Active |

## Switch Outputs

Used to route the specified input to the selected output(s). To route a source, place a check mark next to each Output. Next, click the radio button next to the desired Input. Press the Switch button to apply the routing change.

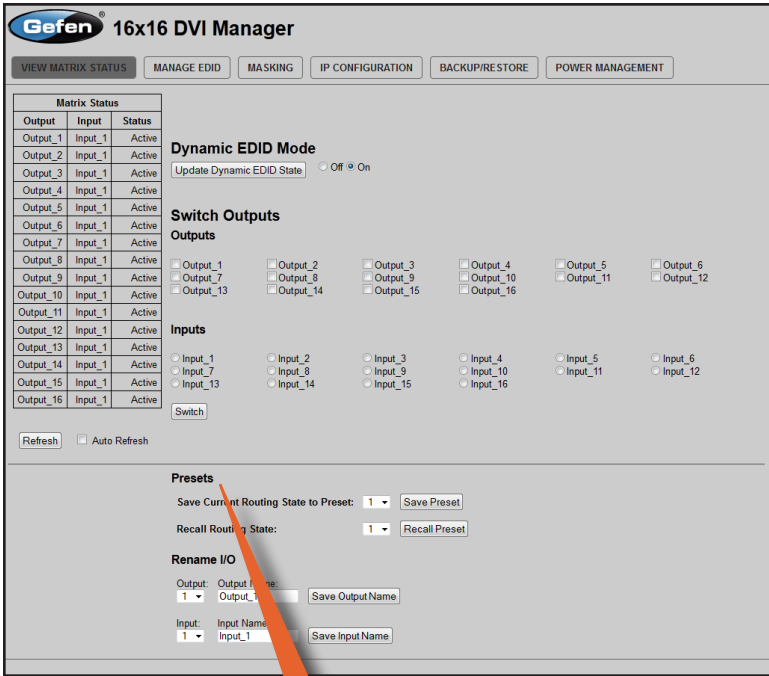

## Presets

Provides saving and recalling of routing states.

Pull-down list



## Recall Preset

Click the down-arrow on the pull-down list to select the routing state (1-16) to recall. Click the Recall Preset button to recall the preset.

## Save Preset

Click the down-arrow on the pull-down list to select the preset location (1-16). Click the Save Preset button to save the preset.

**Gefen 16x16 DVI Manager**

VIEW MATRIX STATUS | MANAGE EDID | MASKING | IP CONFIGURATION | BACKUP/RESTORE | POWER MANAGEMENT

| Output    | Input   | Status |
|-----------|---------|--------|
| Output_1  | Input_1 | Active |
| Output_2  | Input_1 | Active |
| Output_3  | Input_1 | Active |
| Output_4  | Input_1 | Active |
| Output_5  | Input_1 | Active |
| Output_6  | Input_1 | Active |
| Output_7  | Input_1 | Active |
| Output_8  | Input_1 | Active |
| Output_9  | Input_1 | Active |
| Output_10 | Input_1 | Active |
| Output_11 | Input_1 | Active |
| Output_12 | Input_1 | Active |
| Output_13 | Input_1 | Active |
| Output_14 | Input_1 | Active |
| Output_15 | Input_1 | Active |
| Output_16 | Input_1 | Active |

**Dynamic EDID Mode**  
Update Dynamic EDID State:  Off  On

**Switch Outputs**

**Outputs**

Output\_1  Output\_2  Output\_3  Output\_4  Output\_5  Output\_6  
 Output\_7  Output\_8  Output\_9  Output\_10  Output\_11  Output\_12  
 Output\_13  Output\_14  Output\_15  Output\_16

**Inputs**

Input\_1  Input\_2  Input\_3  Input\_4  Input\_5  Input\_6  
 Input\_7  Input\_8  Input\_9  Input\_10  Input\_11  Input\_12  
 Input\_13  Input\_14  Input\_15  Input\_16

Refresh  Auto Refresh

**Presets**

Save Current Routing State to Preset: 1 Save Preset

Recall Routing State: 1 Recall Preset

**Rename I/O**

Output: Output Name:  
1 Output\_1 Save Output Name

Input: Input Name:  
1 Input\_1 Save Input Name

## Rename I/O

Provides custom naming of each input and output on the matrix.

Pull-down list

**Rename I/O**

Output: 1 Output Name: Output\_1 Save Output Name

Input: 1 Input Name: Input\_1 Save Input Name

## Input

Select the DVI input to rename from the pull-down list. Type the name of the input in the Input Name field. Click the Save Input Name button to save changes. See page 53 for naming restrictions.

## Output

Select the DVI output to rename from the pull-down list. Type the name of the output in the Output Name field. Click the Save Output Name button to save changes. See page 55 for naming restrictions.

# WEB INTERFACE

## Manage EDID

### EDID Status

Displays the current EDID status for each input on the matrix. See page 36 for more information on locking the EDID.

EDID Status - Lock State: OFF

| Input    | EDID Source | Name         |
|----------|-------------|--------------|
| Input_1  | Default     | GEFEN_XPT_DL |
| Input_2  | Default     | GEFEN_XPT_DL |
| Input_3  | Default     | GEFEN_XPT_DL |
| Input_4  | Default     | GEFEN_XPT_DL |
| Input_5  | Default     | GEFEN_XPT_DL |
| Input_6  | Default     | GEFEN_XPT_DL |
| Input_7  | Default     | GEFEN_XPT_DL |
| Input_8  | Default     | GEFEN_XPT_DL |
| Input_9  | Default     | GEFEN_XPT_DL |
| Input_10 | Default     | GEFEN_XPT_DL |
| Input_11 | Default     | GEFEN_XPT_DL |
| Input_12 | Default     | GEFEN_XPT_DL |
| Input_13 | Default     | GEFEN_XPT_DL |
| Input_14 | Default     | GEFEN_XPT_DL |
| Input_15 | Default     | GEFEN_XPT_DL |
| Input_16 | Default     | GEFEN_XPT_DL |

Refresh  Auto Refresh

**Refresh**  
Click to refresh the Matrix Status screen

### Auto Refresh

Check this box to enable Auto Refresh. Auto Refresh will automatically update the screen every 10 seconds.

# WEB INTERFACE

## Set Input to Default EDID

### Set Input to Default EDID

Press this button from the Manage EDID screen to access this menu system.

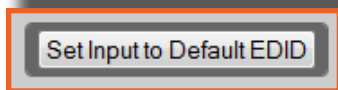

**Gefen 16x3 DVI Manager**

VIEW MATRIX STATUS | **MANAGE EDID** | MASKING | IP CONFIGURATION | BACKUP/RESTORE | POWER MANAGEMENT

Set Input to Default EDID | Upload EDID | Download EDID | Copy EDID | EDID Lock State

EDID Status - Lock State: OFF

| Input    | EDID Source | Name         |
|----------|-------------|--------------|
| Input_1  | Default     | GEFEN_XPT_DL |
| Input_2  | Default     | GEFEN_XPT_DL |
| Input_3  | Default     | GEFEN_XPT_DL |
| Input_4  | Default     | GEFEN_XPT_DL |
| Input_5  | Default     | GEFEN_XPT_DL |
| Input_6  | Default     | GEFEN_XPT_DL |
| Input_7  | Default     | GEFEN_XPT_DL |
| Input_8  | Default     | GEFEN_XPT_DL |
| Input_9  | Default     | GEFEN_XPT_DL |
| Input_10 | Default     | GEFEN_XPT_DL |
| Input_11 | Default     | GEFEN_XPT_DL |
| Input_12 | Default     | GEFEN_XPT_DL |
| Input_13 | Default     | GEFEN_XPT_DL |
| Input_14 | Default     | GEFEN_XPT_DL |
| Input_15 | Default     | GEFEN_XPT_DL |
| Input_16 | Default     | GEFEN_XPT_DL |

Select Input(s) to Set to Default:

Input\_1     Input\_2     Input\_3     Input\_4     Input\_5  
 Input\_6     Input\_7     Input\_8     Input\_9     Input\_10  
 Input\_11     Input\_12     Input\_13     Input\_14     Input\_15  
 Input\_16

Set Default EDID

Refresh     Auto Refresh

**Select Input(s) to Set to Default:**

Input\_1     Input\_2     Input\_3     Input\_4  
 Input\_6     Input\_7     Input\_8     Input\_9  
 Input\_11     Input\_12     Input\_13     Input\_14  
 Input\_16

Set Default EDID

### Set Default EDID

Place a check mark next to the input(s) that should be set to the default EDID. Click the Set Default EDID button to apply the default EDID to the selected inputs.

## Upload EDID

### Upload EDID

Press this button from the Manage EDID screen to access this menu system.

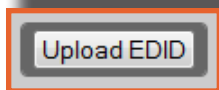

**Gefen® 16x6 DVI Manager**

VIEW MATRIX STATUS   **MANAGE EDID**   MASKING   IP CONFIGURATION   BACKUP/RESTORE   POWER MANAGEMENT

Set Input to Default EDID   **Upload EDID**   Download EDID   Copy EDID   EDID Lock State

EDID Status - Lock State: OFF

| Input    | EDID Source | Name         |
|----------|-------------|--------------|
| Input_1  | Default     | GEFEN_XPT_DL |
| Input_2  | Default     | GEFEN_XPT_DL |
| Input_3  | Default     | GEFEN_XPT_DL |
| Input_4  | Default     | GEFEN_XPT_DL |
| Input_5  | Default     | GEFEN_XPT_DL |
| Input_6  | Default     | GEFEN_XPT_DL |
| Input_7  | Default     | GEFEN_XPT_DL |
| Input_8  | Default     | GEFEN_XPT_DL |
| Input_9  | Default     | GEFEN_XPT_DL |
| Input_10 | Default     | GEFEN_XPT_DL |
| Input_11 | Default     | GEFEN_XPT_DL |
| Input_12 | Default     | GEFEN_XPT_DL |
| Input_13 | Default     | GEFEN_XPT_DL |
| Input_14 | Default     | GEFEN_XPT_DL |
| Input_15 | Default     | GEFEN_XPT_DL |
| Input_16 | Default     | GEFEN_XPT_DL |

Select Input(s) to Upload to:

Input\_1    Input\_2    Input\_3    Input\_4    Input\_5  
 Input\_6    Input\_7    Input\_8    Input\_9    Input\_10  
 Input\_11    Input\_12    Input\_13    Input\_14    Input\_15  
 Input\_16

Upload EDID File

**Select Input(s) to Upload to:**

Input\_1    Input\_2    Input\_3    Input\_4  
 Input\_6    Input\_7    Input\_8    Input\_9  
 Input\_11    Input\_12    Input\_13    Input\_14  
 Input\_16

**Upload EDID File**

### Load EDID file

Place a check mark next to the input(s) that will receive the EDID data from the file. The EDID file must be in .bin format. Click the Browse button to locate the EDID on the computer. Click the Load EDID file button to upload the EDID file to the matrix.

## Download EDID

### Download EDID

Press this button from the Manage EDID screen to access this menu system.

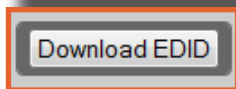

**Gefen 16x16 DVI Manager**

VIEW MATRIX STATUS   MANAGE EDID   MASKING   IP CONFIGURATION   BACKUP/RESTORE   POWER MANAGEMENT

Set Input to Default EDID   Upload EDID   **Download EDID**   Copy EDID   EDID Lock State

EDID Status - Lock State: OFF

| Input    | EDID Source | Name         |
|----------|-------------|--------------|
| Input_1  | Default     | GEFEN_XPT_DL |
| Input_2  | Default     | GEFEN_XPT_DL |
| Input_3  | Default     | GEFEN_XPT_DL |
| Input_4  | Default     | GEFEN_XPT_DL |
| Input_5  | Default     | GEFEN_XPT_DL |
| Input_6  | Default     | GEFEN_XPT_DL |
| Input_7  | Default     | GEFEN_XPT_DL |
| Input_8  | Default     | GEFEN_XPT_DL |
| Input_9  | Default     | GEFEN_XPT_DL |
| Input_10 | Default     | GEFEN_XPT_DL |
| Input_11 | Default     | GEFEN_XPT_DL |
| Input_12 | Default     | GEFEN_XPT_DL |
| Input_13 | Default     | GEFEN_XPT_DL |
| Input_14 | Default     | GEFEN_XPT_DL |
| Input_15 | Default     | GEFEN_XPT_DL |
| Input_16 | Default     | GEFEN_XPT_DL |

Select EDID to Download

Output\_1    Output\_2    Output\_3    Output\_4    Output\_5  
 Output\_6    Output\_7    Output\_8    Output\_9    Output\_10  
 Output\_11    Output\_12    Output\_13    Output\_14    Output\_15  
 Output\_16

Download EDID File to PC

### Select EDID to Download

Output\_1    Output\_2    Output\_3    Output\_4  
 Output\_6    Output\_7    Output\_8    Output\_9  
 Output\_11    Output\_12    Output\_13    Output\_14  
 Output\_16

Download EDID File to PC

### Download EDID File to PC

Select the radio button next to the output, containing the EDID to be downloaded. Click the Download EDID File to PC button to confirm the change. The downloaded EDID file will be in .bin format.

## Copy EDID

### Copy EDID

Press this button from the Manage EDID screen to access this menu system.

Copy EDID

**Gefen® 16x16 DVI Manager**

VIEW MATRIX STATUS | MANAGE EDID | MASKING | IP CONFIGURATION | BACKUP/RESTORE | POWER MANAGEMENT

Set Input to Default EDID | Upload EDID | Download EDID | **Copy EDID** | EDID Lock State

EDID Status - Lock State: OFF

| Input   | EDID Source | Name         |
|---------|-------------|--------------|
| Input_1 | Default     | GEFEN_XPT_DL |
| Input_2 | Default     | GEFEN_XPT_DL |
| Input_3 | Default     | GEFEN_XPT_DL |
| Input_4 | Default     | GEFEN_XPT_DL |
| Input_5 | Default     | GEFEN_XPT_DL |

**Select Source to Copy from:**

**Output(s):**

Output\_1     Output\_2     Output\_3     Output\_4     Output\_5  
 Output\_6     Output\_7     Output\_8     Output\_9     Output\_10  
 Output\_11     Output\_12     Output\_13     Output\_14     Output\_15  
 Output\_16

**Inputs(s):**

Input\_1     Input\_2     Input\_3     Input\_4  
 Input\_6     Input\_7     Input\_8     Input\_9  
 Input\_11     Input\_12     Input\_13     Input\_14  
 Input\_16

**Select Input(s) to Copy to:**

Input\_1     Input\_2     Input\_3     Input\_4  
 Input\_6     Input\_7     Input\_8     Input\_9  
 Input\_11     Input\_12     Input\_13     Input\_14  
 Input\_16

Set EDID

### Select Source to Copy from / Select Input(s) to Copy to

Click the radio button next to the input or output containing the EDID to copy. Note that only a single input or output can be selected at a time. Place a check mark next to the input(s) where the EDID will be copied. Click the Set EDID button to confirm the operation.



# WEB INTERFACE

## EDID Lock State

### EDID Lock State

Press this button from the Manage EDID screen to access this menu system.

EDID Lock State

The screenshot shows the 'Gefen 16x16 DVI Manager' web interface. At the top, there are navigation tabs: VIEW MATRIX STATUS, MANAGE EDID, MASKING, IP CONFIGURATION, BACKUP/RESTORE, and POWER MANAGEMENT. Below these are buttons for 'Set Input to Default EDID', 'Upload EDID', 'Download EDID', 'Copy EDID', and 'EDID Lock State'. The 'EDID Lock State' button is highlighted with an orange callout box. The main content area features a table titled 'EDID Status - Lock State: OFF' with columns for Input, EDID Source, and Name. The table lists 16 inputs, all with 'Default' as the source and 'GEFEN\_XPT\_DL' as the name. Below the table is the 'EDID Lock State' section, which includes an 'Update EDID Lock State' button and two radio buttons labeled 'Off' and 'On'. A second orange callout box highlights this section, showing a larger view of the 'Update EDID Lock State' button and the radio buttons.

| Input    | EDID Source | Name         |
|----------|-------------|--------------|
| Input_1  | Default     | GEFEN_XPT_DL |
| Input_2  | Default     | GEFEN_XPT_DL |
| Input_3  | Default     | GEFEN_XPT_DL |
| Input_4  | Default     | GEFEN_XPT_DL |
| Input_5  | Default     | GEFEN_XPT_DL |
| Input_6  | Default     | GEFEN_XPT_DL |
| Input_7  | Default     | GEFEN_XPT_DL |
| Input_8  | Default     | GEFEN_XPT_DL |
| Input_9  | Default     | GEFEN_XPT_DL |
| Input_10 | Default     | GEFEN_XPT_DL |
| Input_11 | Default     | GEFEN_XPT_DL |
| Input_12 | Default     | GEFEN_XPT_DL |
| Input_13 | Default     | GEFEN_XPT_DL |
| Input_14 | Default     | GEFEN_XPT_DL |
| Input_15 | Default     | GEFEN_XPT_DL |
| Input_16 | Default     | GEFEN_XPT_DL |

EDID Lock State

Update EDID Lock State  Off  On

Refresh  Auto Refresh

### Update EDID Lock State

Secures the Local EDID and disables the automatic loading of the downstream EDID after the Matrix is powered on. Select the radio button next to the Off or On option then click the Update EDID Lock State button to apply the change.

The EDID Lock State has no effect when the Dynamic EDID function is activated.

## Masking

### Matrix Mask Status / Change

Displays the current masking status for each output.

**Matrix Mask Status/Change**

| Output    | Input   | Status | Click to: |
|-----------|---------|--------|-----------|
| Output_1  | Input_1 | Mask   | Active    |
| Output_2  | Input_2 | Active | Mask      |
| Output_3  | Input_3 | Mask   | Active    |
| Output_4  | Input_2 | Active | Mask      |
| Output_5  | Input_2 | Active | Mask      |
| Output_6  | Input_2 | Active | Mask      |
| Output_7  | Input_2 | Mask   | Active    |
| Output_8  | Input_2 | Active | Mask      |
| Output_9  | Input_2 | Active | Mask      |
| Output_10 | Input_2 | Active | Mask      |
| Output_11 | Input_2 | Active | Mask      |
| Output_12 | Input_2 | Active | Mask      |
| Output_13 | Input_2 | Active | Mask      |
| Output_14 | Input_2 | Active | Mask      |
| Output_15 | Input_2 | Active | Mask      |
| Output_16 | Input_2 | Active | Mask      |

Refresh  Auto Refresh

Save Changes

### Save Changes

Click to save the masking changes.

### Mask

Click the Mask button to mask the selected output. If the output is already masked then the button will read "Active" (enabled). Click the ("Active") button again to toggle the masking state to "Mask" (disabled).

## IP Configuration

### IP Settings

Assigns IP address, subnet, gateway, HTTP listening port, and Telnet port. Note that the MAC address can not be changed. Click the Save button to apply changes. The matrix must be rebooted for the changes to take effect.

**Gefen 16x16 DVI Manager**

VIEW MATRIX STATUS    MANAGE EDID    MASKING    **IP CONFIGURATION**    BACKUP/RESTORE    POWER MANAGEMENT

### IP Settings

MAC Address: 00:1C:91:01:01:B2  
IP Address: 192.168.1.239  
Subnet: 255.255.255.0  
Gateway: 192.168.1.1  
HTTP Port: 80  
TCP Port: 23  
UDP Port: 8

### TCP connection Login Settings

User Name: Administrator  
Old Password: ●●●●●●  
New Password:   
Confirm New Password:   
Force Password:

### UDP Connection Settings

UDP remote IP:   
UDP Remote Port:   
Enable UDP as:

Reset IP Configuration

## IP Settings

MAC Address: 00:1C:91:01:01:B2  
IP Address: 192.168.1.239  
Subnet: 255.255.255.0  
Gateway: 192.168.1.1  
HTTP Port: 80  
TCP Port: 23  
UDP Port: 8

## TCP connection Login Settings

User Name: Administrator  
Old Password: ●●●●●●  
New Password:   
Confirm New Password:   
Force Password:

### Telnet Login Settings

Sets the user name and password for Telnet sessions to the matrix. Click the Save button to apply changes.

# WEB INTERFACE

**Gefen® 16x16 DVI Manager**

VIEW MATRIX STATUS    MANAGE EDID    MASKING    **IP CONFIGURATION**    BACKUP/RESTORE    POWER MANAGEMENT

### IP Settings

MAC Address: 00:1C:91:01:01:B2  
IP Address: 192.168.1.239  
Subnet: 255.255.255.0  
Gateway: 192.168.1.1  
HTTP Port: 80  
TCP Port: 23  
UDP Port: 8

### TCP connection Login Settings

User Name: Administrator  
Old Password: \*\*\*\*\*  
New Password:   
Confirm New Password:   
Force Password:

### UDP Connection Settings

UDP remote IP: 192.168.1.20  
UDP Remote Port: 4096  
Enable UDP access:

Reset IP Configuration to Defaults:

### UDP Connection Settings

UDP remote IP: 192.168.1.20  
UDP Remote Port: 4096  
Enable UDP access:

Reset IP Configuration to Defaults:

## UDP Connection Settings

Sets UDP remote IP and remote port. Also enables or disables UDP access to the matrix. Click the Save button to apply changes.

### Reset

Click the Reset button to restore the factory-default IP settings.

## Backup / Restore

The Backup / Restore feature for the 16x16 DVI Matrix w/ Push Button Control is not currently implemented and will be available in a future release of the firmware.

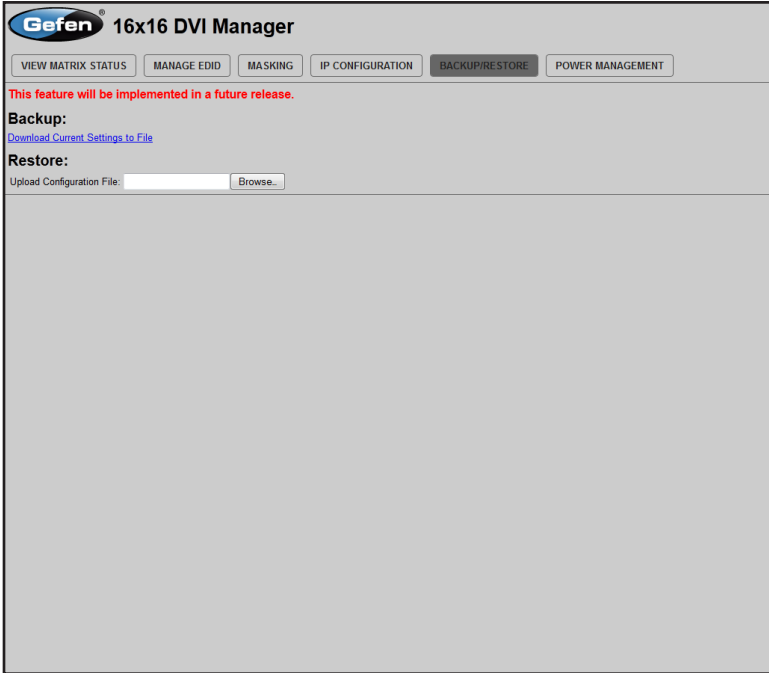

# WEB INTERFACE

## Power Management

### Power Status

Enabling this feature will store the +5V status for that input prior to shutting down the matrix. This preserves the +5V state when the unit is restarted.

**Gefen® 16x16 DVI Manager**

VIEW MATRIX STATUS    MAN...

Warning: Use caution when a...

Power Status - Lock State: OFF

| Input    | 5 volt | Click to: |
|----------|--------|-----------|
| Input_1  | ON     | OFF       |
| Input_2  | ON     | OFF       |
| Input_3  | OFF    | ON        |
| Input_4  | ON     | OFF       |
| Input_5  | ON     | ON        |
| Input_6  | OFF    | ON        |
| Input_7  | OFF    | ON        |
| Input_8  | OFF    | ON        |
| Input_9  | OFF    | ON        |
| Input_10 | OFF    | ON        |
| Input_11 | OFF    | ON        |
| Input_12 | OFF    | ON        |
| Input_13 | OFF    | ON        |
| Input_14 | OFF    | ON        |
| Input_15 | OFF    | ON        |
| Input_16 | OFF    | ON        |

Refresh     Auto Refresh

Save Changes

**Power Lock State**

Update Power Lock State    ON

**Refresh**  
Click to refresh the Power Status screen

**Save Changes**  
Click to save the power lock status.

**Power State**  
The current power state is listed under the column titled "5 Volt". Click these buttons to toggle the input power state.

**Auto Refresh**  
Check this box to automatically update the screen every 10 seconds.

# WEB INTERFACE

**Gefen® 16x16 DVI Manager**

VIEW MATRIX STATUS   MANAGE EDID   MASKING   IP CONFIGURATION   BACKUP/RESTORE   **POWER MANAGEMENT**

**Warning: Use caution when applying power to inputs. It may damage your equipment.**

**Power Status - Lock State: OFF**

| Input    | 5 volt | Click to: |
|----------|--------|-----------|
| Input_1  | ON     | OFF       |
| Input_2  | ON     | OFF       |
| Input_3  | OFF    | ON        |
| Input_4  | ON     | OFF       |
| Input_5  | OFF    | ON        |
| Input_6  | OFF    | ON        |
| Input_7  | OFF    | ON        |
| Input_8  | OFF    | ON        |
| Input_9  | OFF    | ON        |
| Input_10 | OFF    | ON        |
| Input_11 | OFF    | ON        |
| Input_12 | OFF    | ON        |
| Input_13 | OFF    | ON        |
| Input_14 | OFF    | ON        |
| Input_15 | OFF    | ON        |
| Input_16 | OFF    | ON        |

Refresh    Auto Refresh

Save Changes

**Power Lock State**

Update Power Lock State    Off    On

**Power Lock State**

Update Power Lock State    Off    On

## Power Lock State

In the case of an accidental power loss to the matrix, the +5V state for each input can be preserved.

Set the specified Power Status buttons (see previous page) and click the radio button next to ON. Click the Update Power Lock State button to apply changes.

By default, this option is set to Off.

## NETWORK CABLE WIRING DIAGRAM

---

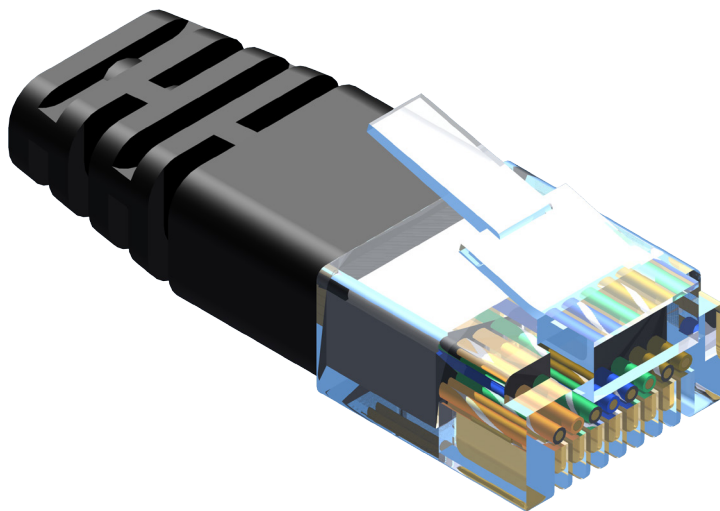

Gefen recommends the TIA/EIA-568-B wiring option. Please adhere to the table below when field-terminating the cable for use with Gefen products.

| Pin | Color          |
|-----|----------------|
| 1   | Orange / White |
| 2   | Orange         |
| 3   | Green / White  |
| 4   | Blue           |
| 5   | Blue / White   |
| 6   | Green          |
| 7   | Brown / White  |
| 8   | Brown          |

Cabling comes in stranded and solid core types. Gefen recommends using solid core cabling.

It is recommended to use one continuous run from one end to the other. Connecting through a patch is not recommended.



## **RACK MOUNT SAFETY INFORMATION**

---

- a. Maximum recommended ambient temperature: 45 °C (104 °F).
- b. Increase the air flow as needed to maintain the recommended temperature inside the rack.
- c. Do not exceed maximum weight loads for the rack. Install heavier equipment in the lower part of the rack to maintain stability.
- d. Connect a bonding wire between an approval safety ground stud on the chassis.

## SPECIFICATIONS

---

|                                 |  |
|---------------------------------|--|
| Maximum Pixel Clock .....       | 165 MHz                                    |
| Input Video Signal .....        | 1.2 Volts p-p                              |
| Video Input Connectors.....     | (16) DVI-I 29-pin, female (digital only)   |
| Video output Connectors.....    | (16) DVI-I 29-pin, female (digital only)   |
| IR Extender.....                | 3.5 mm mini-stereo                         |
| RS-232 Interface.....           | DB-9 serial, female                        |
| Ethernet (IP control) port..... | RJ-45 (100BaseT)                           |
| Power Supply.....               | 100 ~ 240 V AC                             |
| Power Consumption .....         | 90 Watts (max.)                            |
| Operating Temperature.....      | +32 to +104 °F (0 to +40 °C)               |
| Storage Temperature.....        | -4 to +140 °F (-20 to +60 °C)              |
| Relative Humidity.....          | 20 to 90% RH (no condensation)             |
| Dimensions (W x H x D) .....    | 17.25" x 3.5" x 12" (438mm x 89mm x 305mm) |
| Rack-mountable .....            | 2U rack space, rack ears included          |
| Shipping Weight .....           | 30 lbs. (13.6 kg)                          |

## WARRANTY

---

Gefen warrants the equipment it manufactures to be free from defects in material and workmanship.

If equipment fails because of such defects and Gefen is notified within two (2) years from the date of shipment, Gefen will, at its option, repair or replace the equipment, provided that the equipment has not been subjected to mechanical, electrical, or other abuse or modifications. Equipment that fails under conditions other than those covered will be repaired at the current price of parts and labor in effect at the time of repair. Such repairs are warranted for ninety (90) days from the day of reshipment to the Buyer.

This warranty is in lieu of all other warranties expressed or implied, including without limitation, any implied warranty or merchantability or fitness for any particular purpose, all of which are expressly disclaimed.

1. Proof of sale may be required in order to claim warranty.
2. Customers outside the US are responsible for shipping charges to and from Gefen.
3. Copper cables are limited to a 30 day warranty and cables must be in their original condition.

The information in this manual has been carefully checked and is believed to be accurate. However, Gefen assumes no responsibility for any inaccuracies that may be contained in this manual. In no event will Gefen be liable for direct, indirect, special, incidental, or consequential damages resulting from any defect or omission in this manual, even if advised of the possibility of such damages. The technical information contained herein regarding the features and specifications is subject to change without notice.

For the latest warranty coverage information, refer to the Warranty and Return Policy under the Support section of the Gefen Web site at [www.gefen.com](http://www.gefen.com).

### PRODUCT REGISTRATION

**Please register your product online by visiting the Register Product page under the Support section of the Gefen Web site.**

# LICENSING

---

This product uses software that is subject to open source licenses, including one or more of the General Public License Version 2 and Version 2.1, Lesser General Public License Version 2.1 and Version 3, BSD, and BSD-style licenses. Distribution and use of this product is subject to the license terms and limitations of liability provided in those licenses. Specific license terms and Copyright Notifications are provided in the source code.

For three years from date of activation of this product, any party may request, and we will supply, for software covered by an applicable license (e.g. GPL or LGPL), a complete machine-readable copy of the corresponding open source code on a medium customarily used for software interchange. The following software and libraries are included with this product and subject to their respective open source licenses:

- lwIP
- freeRTOS
- jQuery

lwIP is licenced under the BSD licence:

Copyright (c) 2001-2004 Swedish Institute of Computer Science.  
All rights reserved.

Redistribution and use in source and binary forms, with or without modification, are permitted provided that the following conditions are met:

1. Redistributions of source code must retain the above copyright notice, this list of conditions and the following disclaimer.
2. Redistributions in binary form must reproduce the above copyright notice, this list of conditions and the following disclaimer in the documentation and/or other materials provided with the distribution.
3. The name of the author may not be used to endorse or promote products derived from this software without specific prior written permission.

THIS SOFTWARE IS PROVIDED BY THE AUTHOR "AS IS" AND ANY EXPRESS OR IMPLIED WARRANTIES, INCLUDING, BUT NOT LIMITED TO, THE IMPLIED WARRANTIES OF MERCHANTABILITY AND FITNESS FOR A PARTICULAR PURPOSE ARE DISCLAIMED. IN NO EVENT SHALL THE AUTHOR BE LIABLE FOR ANY DIRECT, INDIRECT, INCIDENTAL, SPECIAL, EXEMPLARY, OR CONSEQUENTIAL DAMAGES (INCLUDING, BUT NOT LIMITED TO, PROCUREMENT OF SUBSTITUTE GOODS OR SERVICES; LOSS OF USE, DATA, OR PROFITS; OR BUSINESS INTERRUPTION) HOWEVER CAUSED AND ON ANY THEORY OF LIABILITY, WHETHER IN CONTRACT, STRICT LIABILITY, OR TORT (INCLUDING NEGLIGENCE OR OTHERWISE) ARISING IN ANY WAY OUT OF THE USE OF THIS SOFTWARE, EVEN IF ADVISED OF THE POSSIBILITY OF SUCH DAMAGE.





20600 Nordhoff St., Chatsworth CA 91311  
1-800-545-6900 818-772-9100 fax: 818-772-9120  
www.gefenpro.com support@gefenpro.com

