

Gefen PRO



8x8 DVI Dual Link Matrix with Push Button Controls

GEF-DVI-848DL-PB

User Manual

www.gefenpro.com

ASKING FOR ASSISTANCE

Technical Support:

Telephone (818) 772-9100
(800) 545-6900

Fax (818) 772-9120

Technical Support Hours:

8:00 AM - 5:00 PM Monday - Friday, Pacific Time

For 24 / 7 support, see the back of the product for the support number

Write To:

Gefen LLC
c/o Customer Service
20600 Nordhoff St
Chatsworth, CA 91311

www.gefenpro.com
support@gefenpro.com

Notice

Gefen LLC reserves the right to make changes in the hardware, packaging and any accompanying documentation without prior written notice.

8x8 DVI Dual Link Matrix with Push Button Controls
is a trademark of Gefen LLC

© 2010 Gefen LLC, All Rights Reserved
All trademarks are the property of their respective owners

Rev A2

CONTENTS

1	Introduction
2	Operation Notes
3	Features
4	Front Panel Layout
5	Front Panel Descriptions
6	Back Panel Layout
7	Back Panel Descriptions
8	Connecting The 8x8 DVI Dual Link Matrix
8	Wiring Diagram
9	Front Panel Display
10	IR Remote Control Unit Layout
11	IR Remote Control Unit Installation
12	IR Remote Control Unit Configuration
13	Using the IR Remote Control Unit
14	Operating The 8x8 DVI Dual Link Matrix
14	Routing Sources
15	System Lock Mode
16	Cycling between Information Screens
17	Activating / Deactivating Standby Mode
17	Saving the Downstream EDID to Local Memory
19	Saving the Default EDID to Local Memory
20	Saving the current Routing State
21	Recalling a Routing State
22	Masking Outputs
23	RS-232 Serial Control
24	EDID Management
29	IP Configuration
33	General Functions
36	Commands
38	IP Control
38	View Matrix Status
39	Manage EDID
40	Set to Default EDID
41	Copy EDID
42	Lock EDID
43	Masking
44	IP Configuration
45	Backup / Restore
46	Network Cable Wiring Diagram
47	Firmware Update
48	Rack Mount Safety Information
49	Glossary
56	Specifications
57	Warranty
58	Licensing

INTRODUCTION

Congratulations on your purchase of the GefenPRO 8x8 DVI Dual Link Matrix with Push Button Controls with Push Button Controls. Your complete satisfaction is very important to us.

GefenPRO

In the realm of video distribution, certain features are invaluable in a commercial or broadcast environment. Accommodations such as a build-in power supply and flat black rack-mount enclosures set GefenPRO apart from our traditional products. Complex distribution units allow for professional DVI, 3G-SDI, and HDMI signals to be routed and converted easily and seamlessly, while being backed up by a renowned and dependable technical support team. Gefen invites you to explore the GefenPRO product line and hopes that you find the solution that fits your needs.

The GefenPRO 8x8 DVI Dual Link Matrix with Push Button Controls

The GefenPRO 8x8 DVI Dual Link Matrix with Push Button Controls provides a professional-grade solution to route up to eight DVI sources to any eight DVI displays. Dual link resolutions up to 3840x2400 are supported. The front panel display shows the current routing status and the front panel push buttons are used to manage local source routing. Four methods are available for controlling the GefenPRO 8x8 DVI Dual Link Matrix: front panel push buttons, IR remote, RS-232 interface, or using IP control with the built-in Web interface.

How It Works

Connect up to eight DVI source devices to the GefenPRO 8x8 DVI Dual Link Matrix with Push Button Controls using the supplied DVI cables. Connect up to eight monitors to the DVI outputs. Plug in the power cord and apply power to the Matrix. The DVI sources will be routed according to the current routing selection.

NOTE: The GefenPRO 8x8 DVI Dual Link Matrix with Push Button Controls only supports DVI-D.

OPERATION NOTES

READ THESE NOTES BEFORE INSTALLING OR OPERATING THE GEFENPRO 8X8 DVI DUAL LINK MATRIX WITH PUSH BUTTON CONTROLS

- The 8x8 DVI Dual Link Matrix with Push Button Controls does not support HDCP content.
- When the Matrix is used for the first time, make sure that a DVI monitor is powered and connected to one of the DVI outputs on the 8x8 DVI Dual Link Matrix with Push Button Controls before applying power. By default, the Local EDID is read from the connected monitor and is copied to all 8 DVI inputs once the Matrix has been turned on. If a monitor is not detected by the Matrix at power-on, a default (internal) EDID of 640x480 will be used. This functionality can be disabled using the Secure Local EDID function through RS-232 control. See page 27 for more information.
- There is no internal scaling in the 8x8 DVI Dual Link Matrix with Push Button Controls. Each monitor attached to the Matrix must be able to display the resolutions output by the source device(s). For maximum compatibility it is recommended that only one common resolution be used by each source device.
- Advanced EDID features are accessible through the RS-232 serial command set or using IP Control.
- **IMPORTANT:** If the unit is installed in a closed or multi-rack assembly, do not block the ventilation holes of the enclosure.

FEATURES

Features

- Increases productivity
- Supports resolutions up to 1920x1200 (Single Link) and 3840x2400 (Dual Link)
- Front panel control buttons for local switching
- Serial RS-232 interface for remote control via a computer or control automation devices
- IP Control
- Discrete IR remote control switching
- Advanced EDID management permits upload of custom internal or external EDID settings
- Supports DDWG standards for DVI
- Built-in power supply
- Output masking command
- Standby mode
- Grounding pin
- IR Sensor
- IR Extender
- Status LCD (shows routing status)
- Firmware upgrade via RS-232
- Power On/Off switch
- Rack-mountable

Package Includes

- (1) GefenPRO 8x8 DVI Dual Link Matrix with Push Button Controls with Push Button Controls
- (8) 6 ft. DVI Dual Link cables (M-M)
- (1) IR Remote Control Unit
- (1) AC Power Cord
- (1) User Manual

PANEL LAYOUT

Front Panel

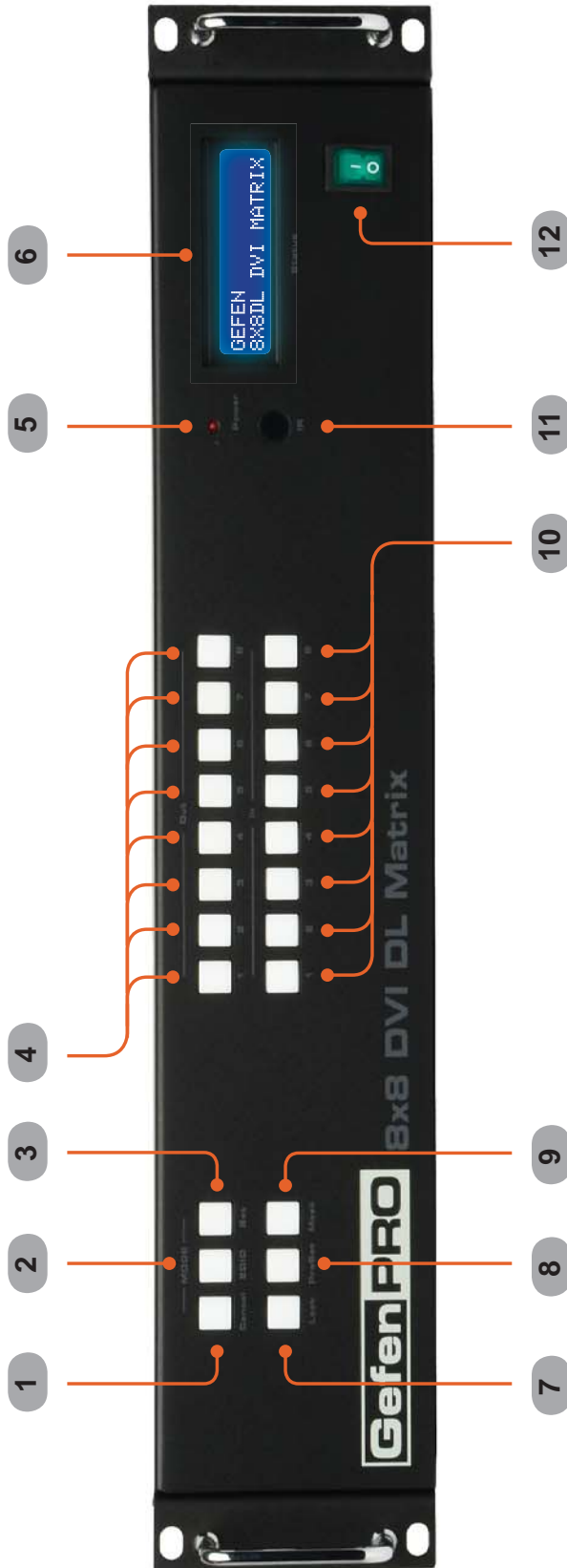

PANEL DESCRIPTIONS

Front Panel

- 1 Cancel**
This button is used to cancel a routing change in progress.
- 2 EDID**
This button is used to manage EDID functions. See pages 17 - 19 for details.
- 3 Set**
This button is used to store and recall EDID and routing functions. See pages 14 - 22 for details.
- 4 Out (1 - 8)**
These buttons are used to select the output when routing a source.
- 5 Power**
This LED will glow bright red when the AC power cord is connected to an available electrical outlet.
- 6 LCD Display**
Displays the current routing status of the Matrix and is also used to manage source routing.
- 7 Lock**
This button enables / disables the locking of the front panel buttons, preventing accidental changes.
- 8 Preset**
The Preset button is used to select or recall stored preset routing states.
- 9 Mask**
This button is used to mask (disable / enable) displays from receiving a video signal from the Matrix.
- 10 In (1 - 8)**
These buttons are used to select the input when routing to a display.
- 11 IR Window**
Receives signals from the IR Remote Control unit.
- 12 Power Switch**
Powers the Matrix ON or OFF.

PANEL LAYOUT

Back Panel

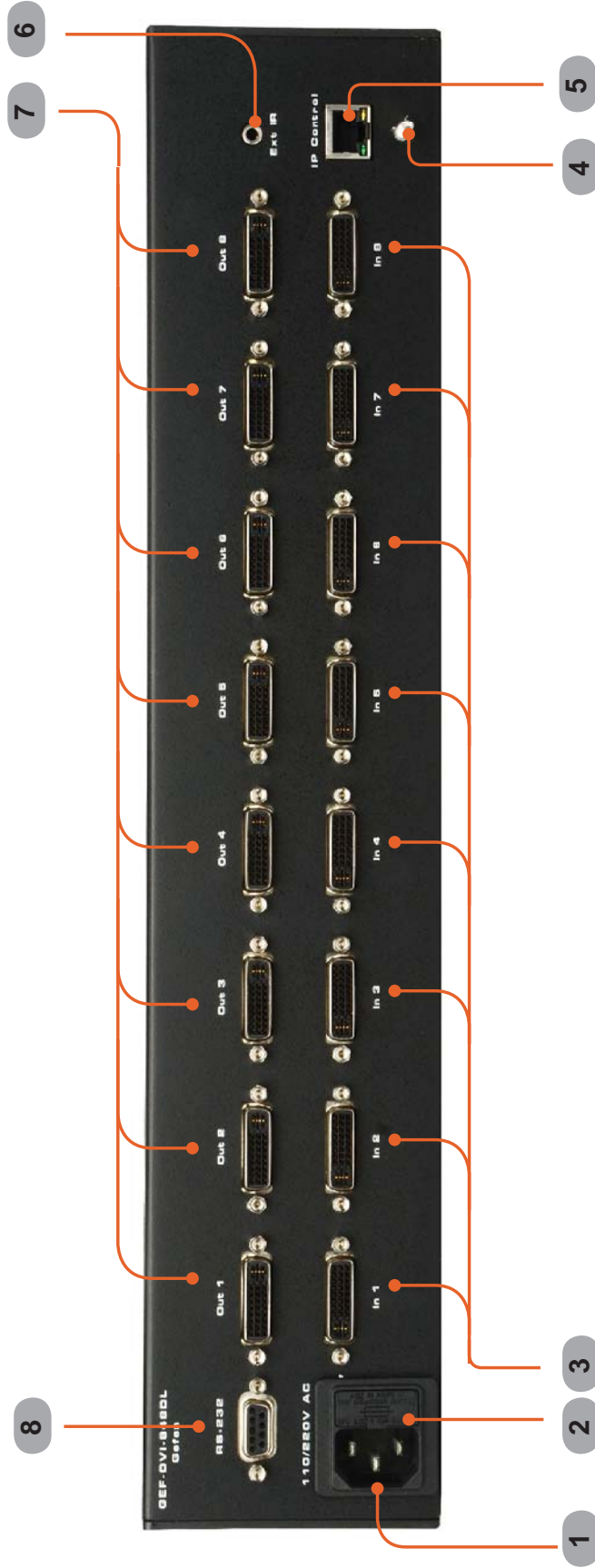

PANEL DESCRIPTIONS

Back Panel

- 1 110 / 220 V AC (50 / 60 Hz) Power Receptacle**
Connect the included AC power cord from this receptacle to an available electrical outlet.
- 2 Fuse Drawer**
Each power receptacle houses a fuse drawer. Within each fuse drawer are two (2) 250 V fuses. One fuse is active and the other is a spare.
- 3 DVI Input Ports (1 - 8)**
Connect DVI source devices to these ports.
- 4 Grounding Terminal**
Provides a discharge path to ground in case a short circuit occurs between the “hot” lead of the power supply and the enclosure of the Matrix. The grounding wire should be attached from the grounding terminal to an approved ground path.
- 5 IP Control Interface**
Connect to this port to control the 8x8 DVI Dual Link Matrix with Push Button Controls using IP Control. See page 38 for details.
- 6 IR Extender Port**
Connect an IR extender cable to this port (Gefen part no. EXT-RMT-EXTIR).
- 7 DVI Output Ports 1-8**
Connect DVI monitors to these ports.
- 8 RS-232 Serial Port**
Connects to the RS-232 control device. The 8x8 DVI Dual Link Matrix with Push Button Controls may be switched remotely using this port. See page 36 for more information.

CONNECTING AND OPERATING THE 8X8 DVI DUAL LINK MATRIX WITH PUSH BUTTON CONTROLS

How to Connect the 8x8 DVI Dual Link Matrix with Push Button Controls

1. Connect up to 8 DVI Dual Link source devices to the inputs on the rear panel of the 8x8 DVI Dual Link Matrix with Push Button Controls using the supplied DVI dual link cables.
2. Connect up to 8 DVI Dual Link monitors to the outputs on the rear panel of the 8x8 DVI Dual Link Matrix with Push Button Controls with user-supplied DVI dual link cables.
3. Connect the included AC power cable to the power receptacle on the rear panel of the 8x8 DVI Dual Link Matrix with Push Button Controls and connect the opposite end of the power cable into an available electrical outlet.

How to Operate the 8x8 DVI Dual Link Matrix with Push Button Controls

The 8x8 DVI Dual Link Matrix with Push Button Controls offers a number of control options. The following methods can be used to control basic routing functions:

1. Front Panel Control Buttons - Page 14
2. IR Remote Control - Page 13
3. RS-232 Serial Control - Pages 23 - 37
4. IP Control - Pages 38 - 45

Wiring Diagram for the GefenPRO 8x8 DVI Dual Link Matrix with Push Button Controls

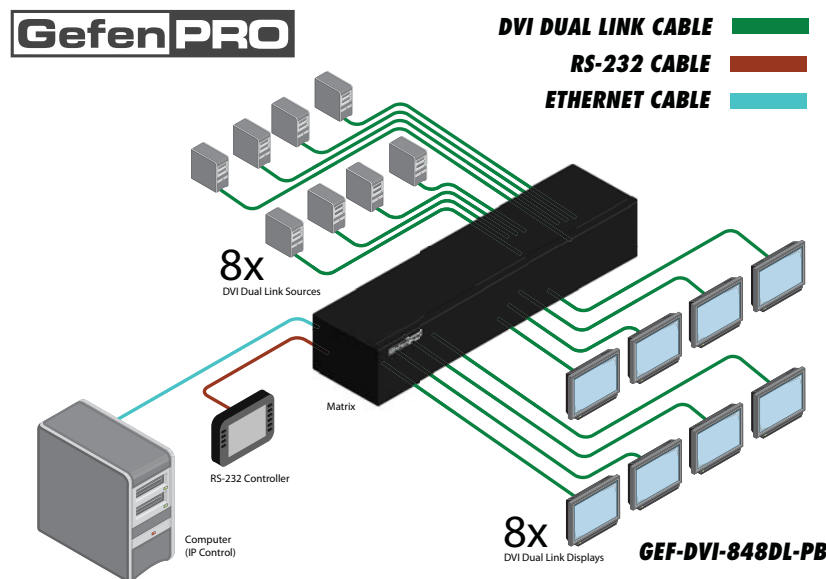

Attention: This product should always be connected to a grounded electrical socket.

FRONT PANEL DISPLAY

Main Display

The **Main Display** of the GefenPRO 8x8 DVI Dual Link Matrix is a 16 character 2 line display. This display will show the standby screen and will also be used to aid in performing routing commands. When the unit is powered on, the following screen is displayed:



```
EDID LOADING
PLEASE WAIT
```

After a few moments, the Standby Screen is displayed. The Standby Screen is shown below:



```
GEFEN
8X8DL DVI MATRIX
```

Displaying Additional Information

Pressing the Cancel button, consecutively, will cycle through screens displaying the firmware version and boot loader version, IP address, MAC address, and the IR remote channel:

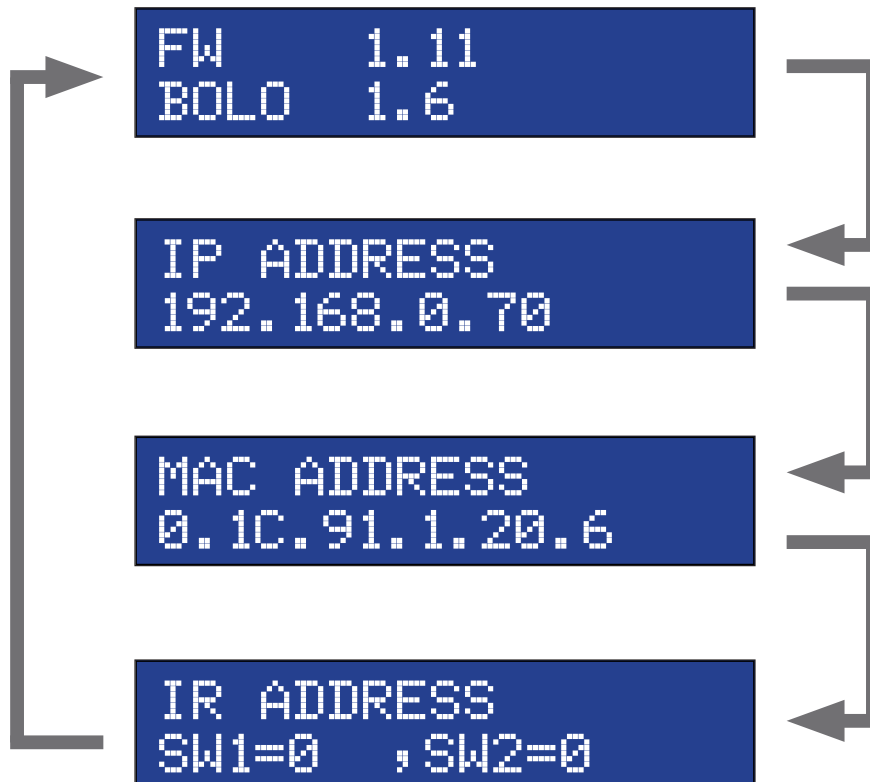

IR REMOTE DESCRIPTION

RMT-16IR Remote Control Unit

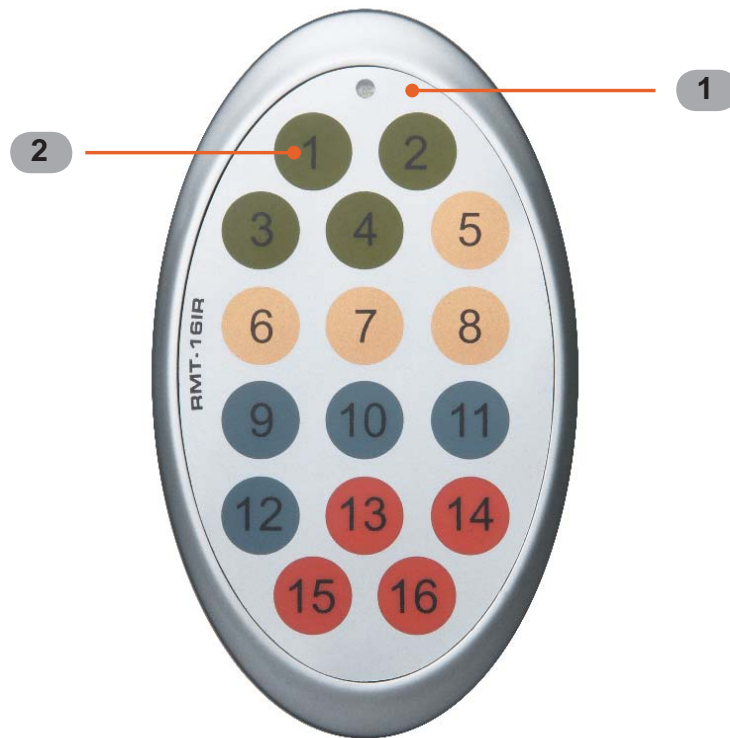

1 Activity Indicator

This LED will be activated momentarily each time a button is pressed.

2 Monitor and Source Selection Buttons

These buttons are used to select which source is routed to a monitor.

See page 13 for information on using the IR Remote Control unit.

IR REMOTE INSTALLATION

Installing the Battery

1. Remove the battery cover on the back of the IR Remote Control unit.
2. Insert the included battery into the open battery slot. The positive (+) side of the battery should be facing up.
3. Replace the battery cover.

The Remote Control unit ships with two batteries. One battery is required for operation and the other battery is a spare.



Empty Battery Slot



CAUTION: Risk of explosion if battery is replaced by an incorrect type. Dispose of used batteries according to the instructions.

IR REMOTE CONFIGURATION

How to Resolve IR Code Conflicts

In the event that IR commands from other remote controls interfere with the supplied IR Remote Control unit, changing the IR channel on the IR Remote Control unit will fix the problem. The IR Remote Control unit has a bank of DIP switches used for setting the IR channel.

The DIP switch bank is located underneath the battery cover.

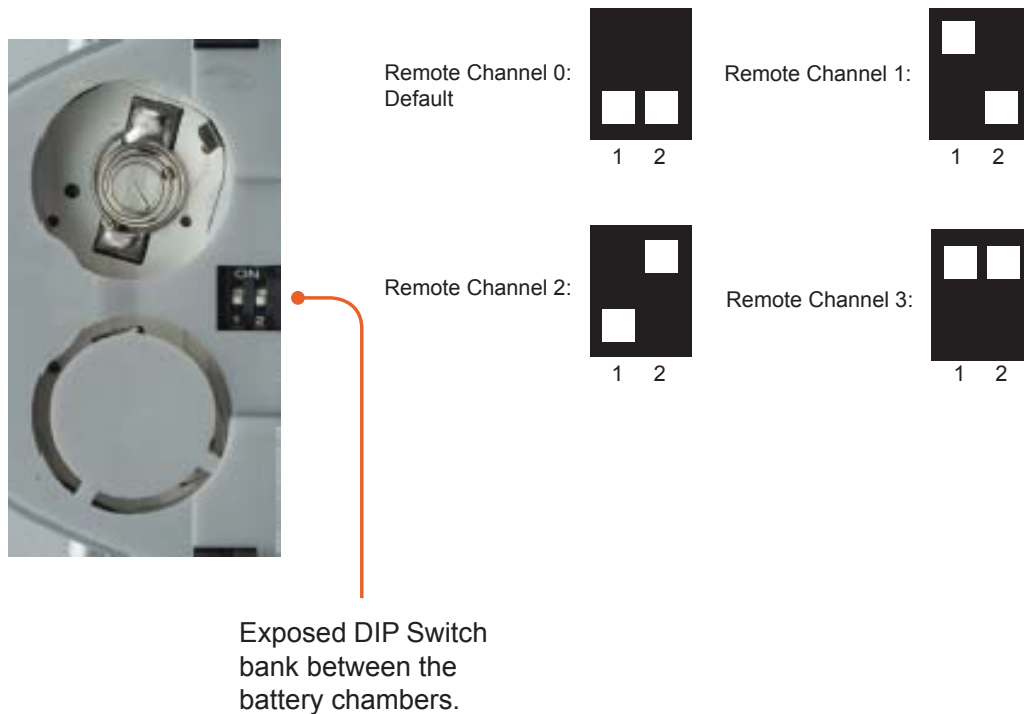

It is important that the IR channel on the Remote Control unit, matches the IR channel set on the 8x8 DVI Dual Link Matrix. For example, if both DIP switches on the IR Remote Control unit are set to IR channel 0 (both DIP switches down), then the 8x8 DVI Dual Link Matrix must also be set to IR channel 0. See page 35 on how to change the IR channel on the 8x8 DVI Dual Link Matrix.

USING THE IR REMOTE CONTROL UNIT

IR Remote Control Key Mapping

Each input and output on the 8x8 DVI Dual Link Matrix with Push Button Controls is represented by a button on the IR Remote Control unit. The table below lists the corresponding inputs and outputs.

Remote Button	Monitor / Source
1	1
2	2
3	3
4	4
5	5
6	6
7	7
8	8

Routing Sources using the IR Remote Control unit

Issuing a routing command is a two step process. The first step is to select the monitor where the source will be routed. The second step is to select the source.

Example 1

Route the source device connected to In 7 to the monitor connected to Out 3.

1. Press button 3 (monitor 3) on the IR remote control unit.
2. Press button 7 (source 7) on the IR remote control unit.

The source connected to In 7 will be routed to the monitor connected to Out 3.

Example 2

Route the source device connected to In 1 to the monitor connected to Out 1.

1. Press button 1 (monitor 1) on the IR remote control unit.
2. Press button 1 (source 1) on the IR remote control unit.

The source connected to In 1 will be routed to the monitor connected to Out 1.

OPERATING THE 8X8 DVI DUAL LINK MATRIX

Routing Sources

In order to change current routing state:

- 1 Press Set Button to activate Routing Mode.



- 2 Press any Input on the bottom row of buttons (1 - 8). The system indicates the current routing status.

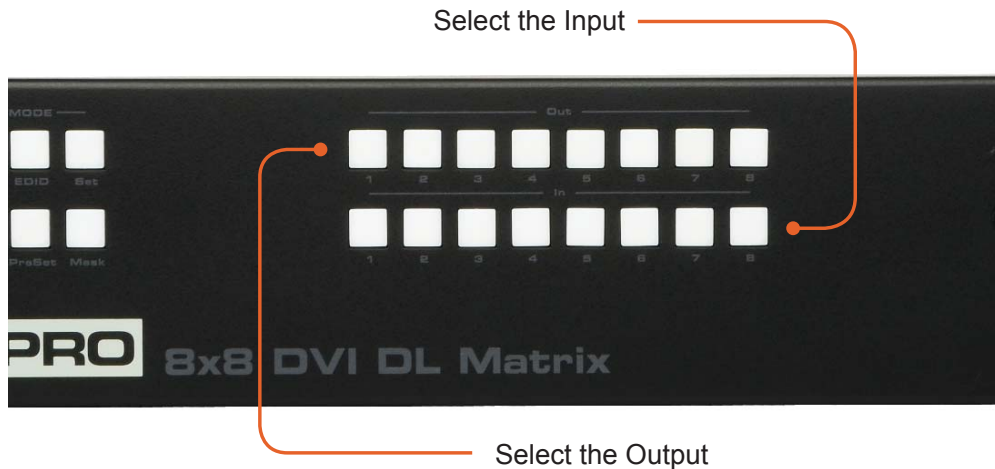

- 3 Press the desired Output button. One or more Output buttons may be selected.
- 4 Press the Set button to complete the operation. The system will remain in Routing Mode.

OPERATING THE 8X8 DVI DUAL LINK MATRIX

System Lock Mode

Locking the Matrix prevents changes to any of the Matrix settings. This feature is useful in case any of the front panel buttons are pressed by accident. Locking the Matrix also prevents changes using the IR Remote Control Unit.

- 1 Press the Lock button to activate System Lock Mode.

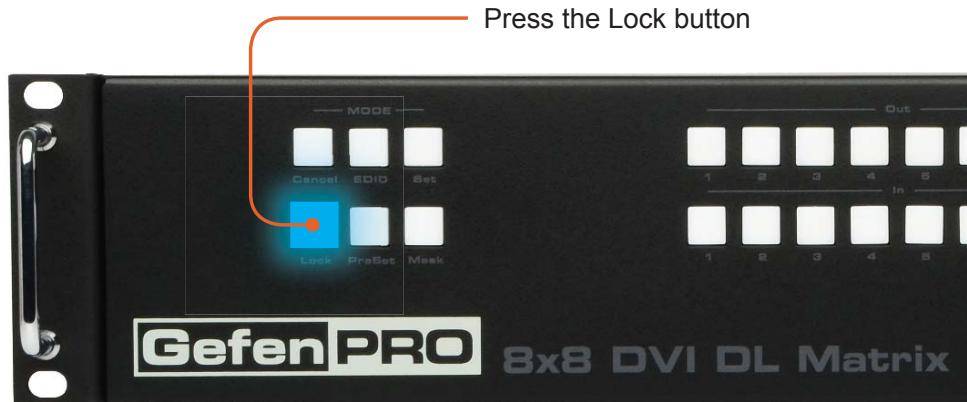

- 2 Press the Lock button a second time to deactivate System Lock Mode.

Returning to Standby Mode

Press the Cancel button, while in any mode, to return to the Standby Mode screen.



OPERATING THE 8X8 DVI DUAL LINK MATRIX

Cycling between Information Screens

Press the Cancel button, while in Status Check Mode, to cycle through the Information Screens.

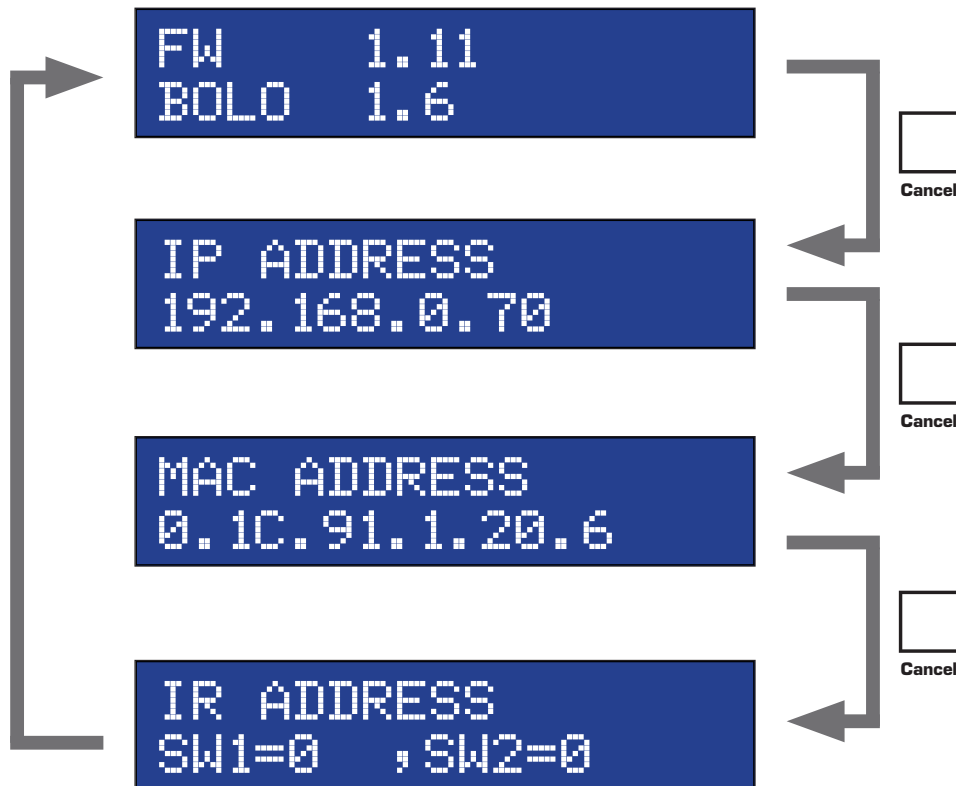

OPERATING THE 8X8 DVI DUAL LINK MATRIX

Activating / Deactivating Standby Mode:

Press and hold the Cancel button for 5 seconds to activate or deactivate Standby Mode.



Saving the Downstream EDID to Local Memory:

- 1 Press EDID button *once* to activate DSTOLO (Downstream To Local) Mode.



OPERATING THE DVI 8X8 DUAL LINK MATRIX

- 2 Press the Output button to select the EDID data source.

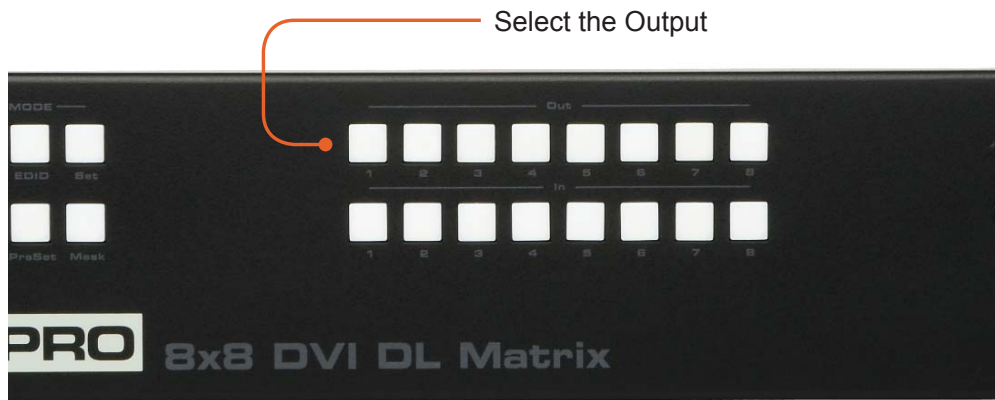

- 3 Press the Input button to select EDID data destination.

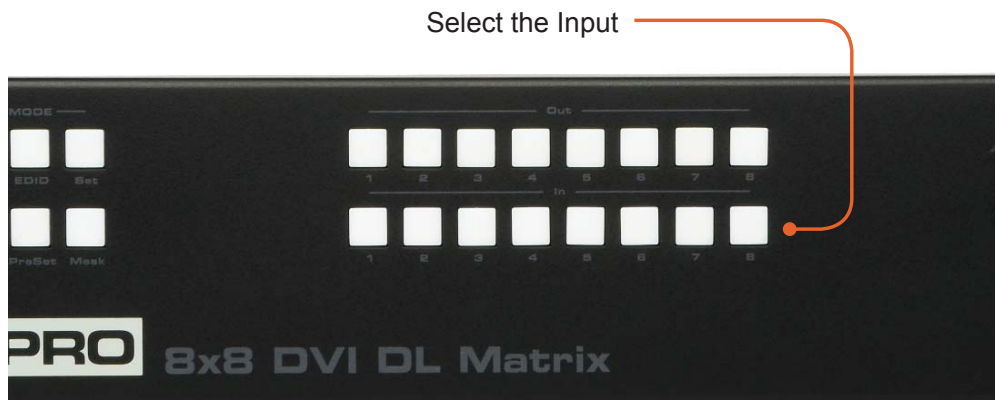

- 4 Press the Set button to complete the operation. The system will remain in DSTOLO mode.



OPERATING THE DVI 8X8 DUAL LINK MATRIX

Saving the default EDID to Local Memory

- 1 Press the EDID button *twice* to activate DETOLO (Default EDID To Local) Mode.



- 2 Press the Input button to select EDID data destination.

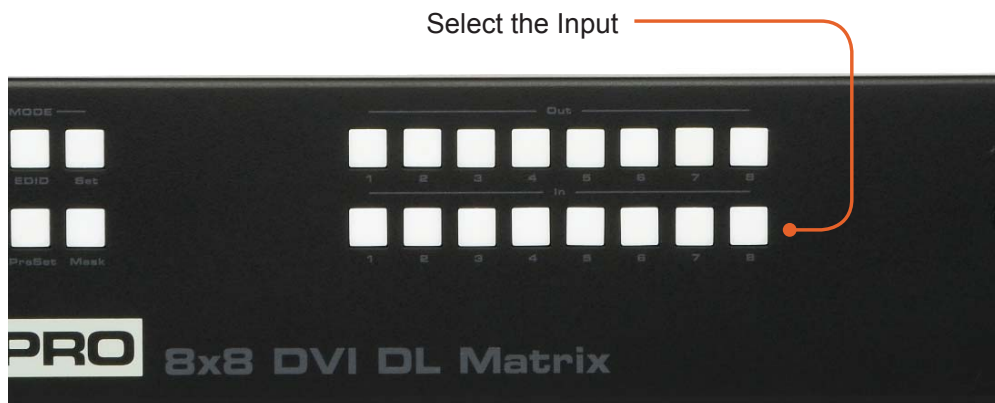

- 3 Press the Set button to complete the operation. The system will remain in DETOLO mode.



OPERATING THE DVI 8X8 DUAL LINK MATRIX

Saving the current Routing State

- 1 Set the routing state (see page 14), then press the PreSet button *twice* to activate Preset Mode.

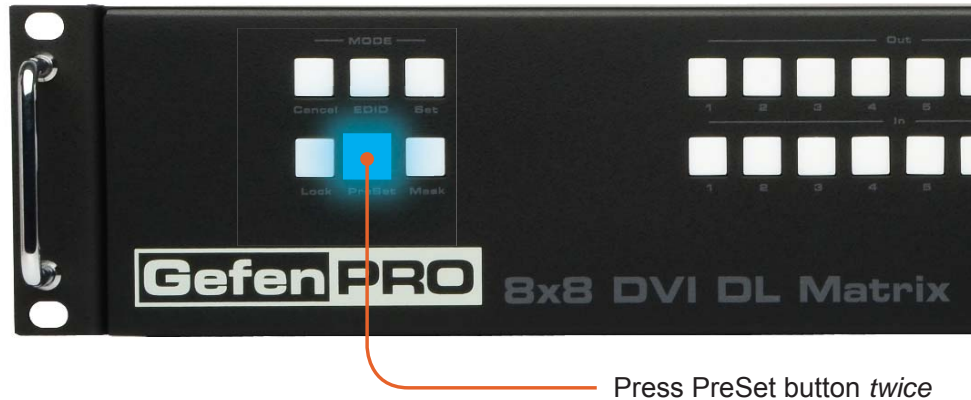

- 2 Press an Input button (1 - 8) to store the current routing state.

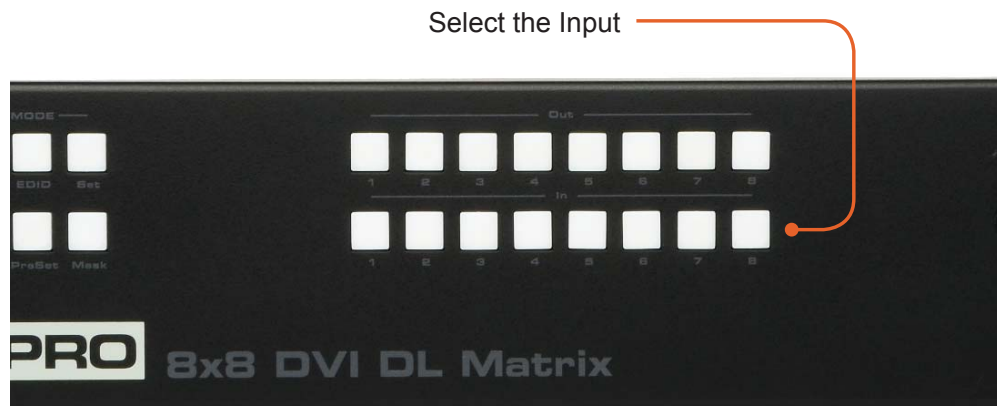

- 3 Press the Set button to complete the operation. The system will remain in Save Current Preset Mode.



OPERATING THE DVI 8X8 DUAL LINK MATRIX

Recalling a Routing State

- 1 Press the PreSet button *once* to activate Recall Preset Mode.



Press PreSet button *twice*

- 2 Press the Input button (1 - 8) of the routing state to be recalled.

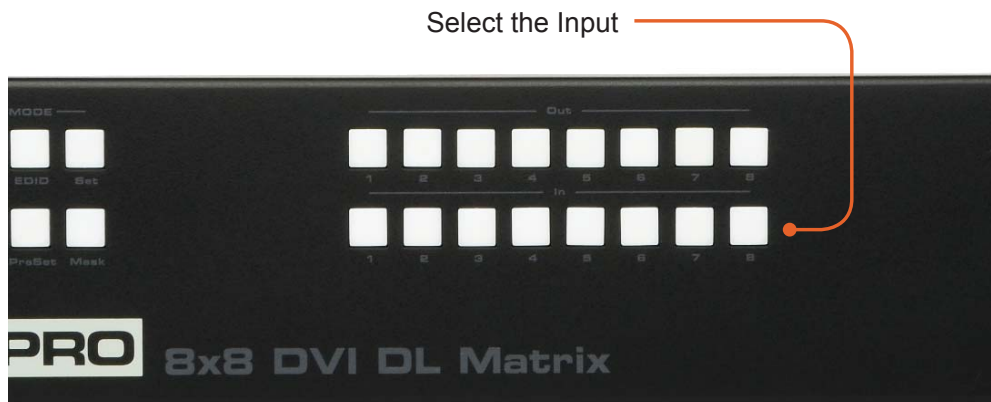

Select the Input

- 3 Press the Set button to complete the operation. The system will remain in Recall Saved Set Mode.



Press the Set button

OPERATING THE DVI 8X8 DUAL LINK MATRIX

Masking Outputs

Masking prevents the output device (display, etc) from receiving an output signal, instead of powering-down the output device. The masking process is identical for masking or unmasking outputs.

- 1 Press the Mask button to activate Mask Mode.



- 2 Select the Output to be masked.

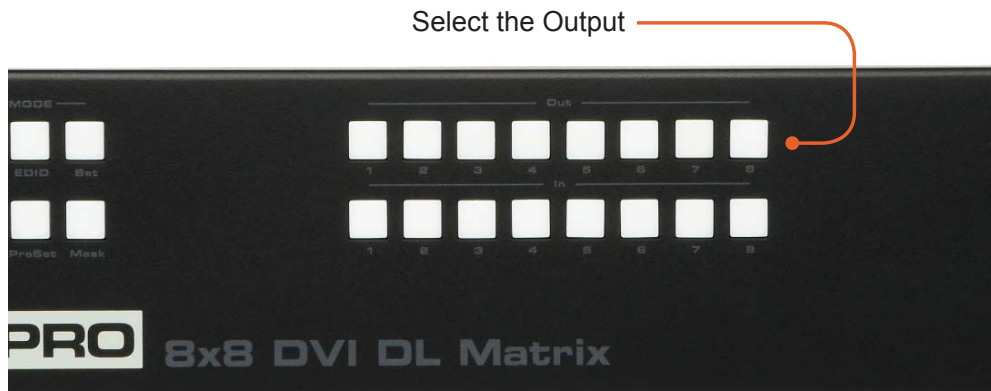

- 3 Press the Set button to complete the operation. The system will remain in Save Current Preset Mode.



RS-232 SERIAL CONTROL

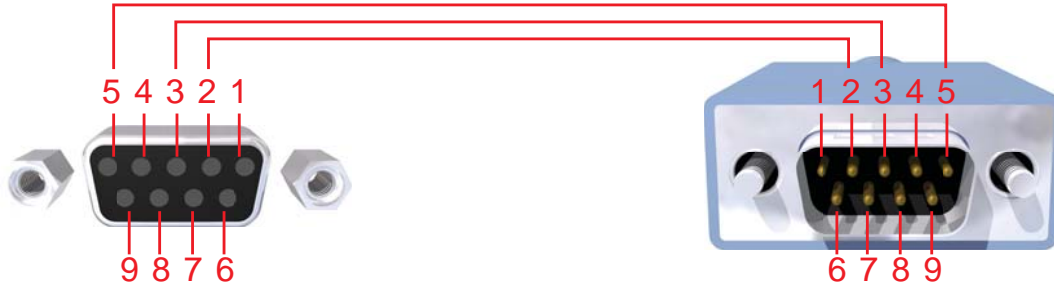

Only Pins 2 (RX), 3 (TX), and 5 (Ground) are used on the RS-232 serial interface

RS232 Settings

Bits per second 19200

Data bits 8

Parity None

Stop bits1

Flow Control None

RS-232 SERIAL CONTROL

RS-232 Features

RS-232 remote functions are used to control of this product's features. Features include input to output routing, EDID storage, EDID management, etc. These functions are available only through the use of the serial port.

Functions Syntax

The syntax for each function is always the same:

Character as the start flag → Function name → Space (_) as function name end flag → Parameter 1 → Space → Parameter n → Carriage Return (\r) →

Sample:

```
#FunctionName_param1_param2_param3_param4...\r
```

Syntax is NOT case sensitive.

EDID Management

Function	Description
#EDIDDSTOLO	Read downstream EDID and stores into a Local EDID
#EDIDDSTOBA	Read downstream EDID and stores in EDID Bank
#EDIDBATOLO	Read downstream EDID and stores in any Local Input
#EDIDDETOLO	Sets Local EDID to Default EDID
#LOCKEDID	Secures Local EDID
#LOEDIDTOLO	Load EDID file using serial port to one of the local memories
#PRLOEDID	Read Input Local EDID and sends to serial port
#PRDSEDID	Read downstream EDID and sends to serial port
#PRBAEDID	Read EDID from an EDID bank and sends to serial port
#PREDIDST	Prints EDID details

RS-232 SERIAL CONTROL

#EDIDDSTOLO Function

The #EDIDDSTOLO function reads the downstream EDID and stores it to a Local EDID input.

Syntax:

```
#EDIDDSTOLO param1 param2 [param3...param9]
```

Parameters:

<i>param1</i>	A downstream monitor	[1 - 8]
<i>param2</i>	Input list	[1 - 8]

Notes:

If *param2* = 0, then the downstream EDID is stored to all 8 DVI inputs.

Examples:

```
#EDIDDSTOLO 2 1 2 3 4 5    inputs 1-5 use display 2 EDID
#EDIDDSTOLO 3 0           all inputs use display 3 EDID
```

#EDIDDSTOBA Function

The #EDIDDSTOBA function reads the downstream EDID and stores it to a specified EDID bank.

Syntax:

```
#EDIDDSTOBA param1 param2
```

Parameters:

<i>param1</i>	A downstream monitor	[1 - 8]
<i>param2</i>	EDID bank offset	[1 - 5]

#EDIDBATOLO Function

The #EDIDBATOLO function reads the downstream EDID and stores it to any local input.

Syntax:

```
#EDIDBATOLO param1 param2 [param3...param9]
```

Parameters:

<i>param1</i>	EDID bank offset	[1 - 5]
<i>param2</i>	Input	[1 - 8]

Notes:

If *param2* = 0, then the EDID in the specified bank is copied to all eight inputs.

#EDIDDETOLO Function

The #EDIDDETOLO function stores the Default EDID (640x480) in the specified Local EDID inputs.

Syntax:

```
#EDIDDETOLO param1 param2 param3...param9
```

<i>param1</i>	Input	[1 - 8]
---------------	-------	---------

Notes:

If *param1* = 0, then all 8 DVI inputs will be set to the Default EDID.

RS-232 SERIAL CONTROL

#LOCKEDID Function

The #LOCKEDID function secures the Local EDID and disables the automatic loading of the downstream EDID after the Matrix is powered on.

Syntax:

#LOCKEDID param1

Parameters:

param1 Input [0 - 1]

Value	Meaning
0	Disable
1	Enable

#LOEDIDTOLO Function

The #LOEDIDTOLO function loads an external EDID via RS-232 to any Local EDID input bank.

Syntax:

#LOEDIDTOLO param1 param2 param3

Parameters:

param1 Input [1 - 8]

param2 EDID size [1 - 2]

Value	Meaning
1	128 byte EDID
2	256 byte EDID

param3 eco [0 - 1]

Notes:

Set *param1* to a value of 0 in order to specify all inputs. When using HyperTerminal, *param3* must be set to 1.

#PRDSEDID Function

The #PRDSEDID function reads the downstream EDID and sends it to the serial port.

Syntax:

```
#PRDSEDID param1
```

Parameters:

<i>param1</i>	A downstream monitor	[1 - 8]
---------------	----------------------	---------

#PRLOEDID Function

The #PRLOEDID function reads the local EDID of a specified input and spools it to the serial port.

Syntax:

```
#PRLOEDID param1
```

Parameters:

<i>param1</i>	A specified Input	[1 - 8]
---------------	-------------------	---------

#PRBAEDID Function

The #PRBAEDID function reads the EDID file from the specified bank and sends to serial port.

Syntax:

```
#PRBAEDID param1
```

Parameters:

<i>param1</i>	Input	[1 - 5]
---------------	-------	---------

RS-232 SERIAL CONTROL

#PREDIDST Function

The #PREDIDST function reads the downstream EDID. This function displays a table containing details relating to the Local EDID and the monitor name.

Syntax:

#PRDSEDID

Parameters:

None

IP Configuration

Function	Description
#PRWEBADD	Displays the Web configuration
#RSTIP	Set IP configuration to default
#SIPADD	Specifies a new IP address
#SNETMASK	Specifies a new net mask
#SGATEWAY	Specifies the new gateway
#SPORT	Specifies a new port

#PRWEBADD Function

The #PRWEBADD displays the IP address, net mask, gateway, MAC address, and port on the screen.

Syntax:

#PRWEBADD

Parameters:

None

#RSTIP Function

The #RSTIP function sets the IP configuration to the default settings.

Syntax:

```
#RSTIP
```

Parameters:

None

Notes:

A reboot is required after restoring the default IP settings.

#SIPADD Function

The #SIPADD function specifies a new IP address.

Syntax:

```
#SIPADD param1 param2 param3 param4
```

Parameters:

<i>param1</i>	IP address	[0 - 255]
<i>param2</i>	IP address	[0 - 255]
<i>param3</i>	IP address	[0 - 255]
<i>param4</i>	IP address	[0 - 255]

Notes:

The default IP address is 192.168.0.70. A reboot is required after the new IP address is set.

#SNETMASK Function

The #SNETMASK function specifies a new subnet mask.

Syntax:

```
#SNETMASK param1 param2 param3 param4
```

Parameters:

<i>param1</i>	IP address	[0 - 255]
<i>param2</i>	IP address	[0 - 255]
<i>param3</i>	IP address	[0 - 255]
<i>param4</i>	IP address	[0 - 255]

Notes:

The default subnet mask is 255.255.255.0. A reboot is required after the new subnet mask has been set.

#SGATEWAY Function

Specifies the new IP gateway (router) address.

Syntax:

```
#SGATEWAY param1 param2 param3 param4
```

Parameters:

<i>param1</i>	Gateway address	[0 - 255]
<i>param2</i>	Gateway address	[0 - 255]
<i>param3</i>	Gateway address	[0 - 255]
<i>param4</i>	Gateway address	[0 - 255]

Notes:

The default gateway address is 192.168.0.1. A reboot is required after the gateway address has been assigned.

RS-232 SERIAL CONTROL

#SPORT Function

Specifies a new port.

Syntax:

```
#SPORT param1
```

Parameters:

<i>param1</i>	Port	[0 - 255]
---------------	------	-----------

Notes:

The default port setting is 80. A reboot is required after the new port has been created.

RS-232 SERIAL CONTROL

General Functions

Function	Description
#ACTIVEBOLO	Enables the boot loader
#FADEFAULT	Set matrix to default settings
#LOCKPOWER	Toggles the lock power state
#MASKOUT	Blanks selected outputs
#RMTIRADD	Set the remote IR channel
#STBYMODE	Sets the Matrix to Standby Mode

#ACTIVEBOLO Function

The #ACTIVEBOLO function enables the boot loader allowing the Matrix to be updated with firmware using RS-232.

Syntax:

#ACTIVEBOLO

Parameters:

None

Notes:

The #ACTIVEBOLO command must be typed twice in order to activate the boot loader.

#FADEFAULT Function

The #FADEFAULT function sets all Local EDIDs and routing settings to default, turns off all FO 5V to inputs, sets IR address to 0, and disables #LOCKPOWER, and #LOCKEDID.

Syntax:

#FADEFAULT

Parameters:

None

RS-232 SERIAL CONTROL

#LOCKPOWER Function

The #LOCKPOWER enables/disables the power lock state. Enabling this feature will store the 5V status for each input prior to shutting the unit down. This preserves the 5V state when the Matrix is restarted.

Syntax:

#LOCKPOWER param1

Parameters:

param1 State [0 - 1]

Value	Meaning
0	Disable Power Lock
1	Enable Power Lock

#MASKOUT Function

The #MASKOUT function allows blanking of selected outputs.

Syntax:

#MASKOUT param1 param2

Parameters:

param1 Output [1 - 8]
param2 Value [0 - 1]

Value	Meaning
0	Unmask
1	Mask

Notes:

The current masking state will be lost if power is lost.

RS-232 SERIAL CONTROL

#RMTIRADD Function

The #RMTIRADD function set the remote IR channel.

Syntax:

```
#RMTIRADD param1
```

Parameters:

param1 IR channel [0 - 3]

#STBYMODE Function

The #STBYMODE function disables / enables standby power mode.

Syntax:

```
#STBYMODE param1
```

Parameters:

param1 Disable / Enable [0 - 1]

Value	Meaning
0	Disable Standby Mode
1	Enable Standby Mode

RS-232 SERIAL CONTROL

Commands

Command	Description
<i>R</i>	Routing command
<i>S</i>	Routes a single input to all outputs
<i>M</i>	Returns the current routing status of matrix
<i>F</i>	Toggle 5V fiber optic extender feature

R Command

The R command allows specific routing of inputs and outputs.

Syntax:

```
r param1 param2
```

Parameters:

<i>param1</i>	DVI Output	[1 - 8]
<i>param2</i>	DVI Input	[1 - 8]

S Command

The S command routes a single input to all 8 DVI outputs.

Syntax:

```
s param1
```

Parameters:

<i>param1</i>	Input	[1 - 8]
---------------	-------	---------

Notes:

Setting *param1* to a value of 0 will place the matrix in *one-to-one mode*. This means that Input1 will be routed to Output1, Input2 will be routed to Output2, and so on.

M Command

The M command displays the current routing status of the matrix.

Syntax:

m

Parameters:

None

F Command

The F command returns the state of pin 14 of the DVI inputs.

Syntax:

f param1 param2

Parameters:

<i>param1</i>	DVI input	[1 - 8]
<i>param2</i>	State	[0 - 1]

Notes:

“High” is returned if +5V is enabled on the DVI input. “Low” is returned if +5V is disabled on the DVI input.

IP CONTROL

The 8x8 DVI Dual Link Matrix with Push Button Controls supports IP-based control using an integrated Web interface. To access this feature, an IP address, subnet, gateway, and port number need to be set on the 8x8 DVI Dual Link Matrix with Push Button Controls (**Default IP: 192.168.0.70 Subnet: 255.255.255.0 Gateway: 192.168.0.1 Port: 80**). Consult the network administrator to obtain the proper IP address and settings for this product to properly communicate on the network.

The IP control setting can be configured via the RS-232 control interface. Once this has been accomplished, access to the Web Interface is possible.

Simply type the IP address that was assigned to the product in a web browser to access the **Matrix Status Page**. It should look like the image below.

View Matrix Status

The screenshot shows the 'View Matrix Status' page of the Gefen 8x8 DL DVI Manager. The page has a navigation bar with buttons for 'VIEW MATRIX STATUS', 'MANAGE EDID', 'MASKING', 'IP CONFIGURATION', 'BACKUP/RESTORE', and 'POWER MANAGEMENT'. The main content area includes a 'Refresh' button, a 'Matrix Status' table, 'Switch Outputs' controls, and 'Inputs' controls.

Output	Input	Status
1	1	Active
2	2	Active
3	3	Active
4	4	Active
5	5	Active
6	6	Active
7	7	Active
8	8	Active

Switch Outputs: Output 1 Output 2 Output 3 Output 4 Output 5 Output 6 Output 7 Output 8

Inputs: Input 1 Input 2 Input 3 Input 4 Input 5 Input 6 Input 7 Input 8

Switch

The **View Matrix Status** will display the current status and can also be used to create routes.

To create a new route, follow the steps below:

1. Select which outputs will display the source by clicking on each check box.
2. Select the radio button of the input that will be routed to each output.
3. Click the SWITCH button to update the new routing configuration.

This page will automatically refresh every minute. However, at anytime the "Refresh" button can be pressed to refresh the status of the Matrix.

Manage EDID

Gefen 8x8 DL DVI Manager

VIEW MATRIX STATUS | **MANAGE EDID** | MASKING | IP CONFIGURATION | BACKUP/RESTORE | POWER MANAGEMENT

SET INPUT TO DEFAULT EDID | UPLOAD EDID | DOWNLOAD EDID | COPY EDID | EDID LOCK STATE

Refresh

Input	EDID Source	Name
1	Default	GEFEN_XPT_DL
2	Default	GEFEN_XPT_DL
3	Default	GEFEN_XPT_DL
4	Default	GEFEN_XPT_DL
5	Default	GEFEN_XPT_DL
6	Default	GEFEN_XPT_DL
7	Default	GEFEN_XPT_DL
8	Default	GEFEN_XPT_DL

Refresh

The **Manage EDID** page is used to see the status of the EDID saved in the local storage location for each input. This section has additional tabs for advanced EDID functions. These tabs are:

- SET INPUT TO DEFAULT EDID
- UPLOAD EDID (Future Implementation)
- DOWNLOAD EDID (Future Implementation)
- COPY EDID
- EDID LOCK STATE

This page will automatically refresh every minute. However, at anytime the REFRESH button can be pressed to return the current status of the Matrix.

Manage EDID - Set Input to Default EDID

Pressing the SET INPUT TO DEFAULT EDID button will display additional options. The following page will open.

The screenshot shows the 'Gefen 8x8 DL DVI Manager' web interface. At the top, there are navigation buttons: VIEW MATRIX STATUS, MANAGE EDID (highlighted), MASKING, IP CONFIGURATION, BACKUP/RESTORE, and POWER MANAGEMENT. Below these are more specific buttons: SET INPUT TO DEFAULT EDID (highlighted), UPLOAD EDID, DOWNLOAD EDID, COPY EDID, and EDID LOCK STATE. A 'Refresh' button is located above a table titled 'EDID Status - Lock State:OFF'. The table has three columns: Input, EDID Source, and Name. All EDID sources are 'Default' and names are 'GEFEN_XPT_DL'. To the right of the table, there is a section titled 'Select Input(s) to Set to Default:' with checkboxes for Input 1 through Input 8. A 'Set Default EDID' button is positioned below the checkboxes. Another 'Refresh' button is located below the table.

Input	EDID Source	Name
1	Default	GEFEN_XPT_DL
2	Default	GEFEN_XPT_DL
3	Default	GEFEN_XPT_DL
4	Default	GEFEN_XPT_DL
5	Default	GEFEN_XPT_DL
6	Default	GEFEN_XPT_DL
7	Default	GEFEN_XPT_DL
8	Default	GEFEN_XPT_DL

On this page, local memory locations can be selected to receive the built-in EDID stored in the 16x16 DVI Matrix. To set an input's local memory location to the default EDID follow the steps below.

1. Select any number of inputs by clicking on the desired checkboxes.
2. Click on the **Set Default EDID** button to update the change(s).

Note: After this command is complete the Web Interface will return to the VIEW MATRIX STATUS page.

This page will automatically refresh every minute. However, the REFRESH button can be pressed at any time to return the current status of the Matrix.

Manage EDID - Copy EDID

Pressing the COPY EDID button will display additional options. The following page will open.

The screenshot shows the 'Gefen 8x8 DL DVI Manager' interface. At the top, there are navigation tabs: VIEW MATRIX STATUS, MANAGE EDID (selected), MASKING, IP CONFIGURATION, BACKUP/RESTORE, and POWER MANAGEMENT. Below these are sub-tabs: SET INPUT TO DEFAULT EDID, UPLOAD EDID, DOWNLOAD EDID, COPY EDID (selected), and EDID LOCK STATE. The main area contains a 'Refresh' button, a table titled 'EDID Status - Lock State:OFF', and two selection sections. The table has columns for Input, EDID Source, and Name. The 'Select Source to Copy from:' section has radio buttons for Output 1-8 and Input 1-8. The 'Select Input(s) to Copy to:' section has checkboxes for Input 1-8. A 'Set EDID' button is located below the input selection.

Input	EDID Source	Name
1	Default	GEFEN_XPT_DL
2	Default	GEFEN_XPT_DL
3	Default	GEFEN_XPT_DL
4	Default	GEFEN_XPT_DL
5	Default	GEFEN_XPT_DL
6	Default	GEFEN_XPT_DL
7	Default	GEFEN_XPT_DL
8	Default	GEFEN_XPT_DL

On this page, the user can select an EDID from either the local memory locations (Input) or from a monitor that is currently attached to any output and copy that EDID to any other LOCAL memory location. This will permit control of what EDID information will be passed to each source connected to the 16x16 DVI Matrix.

To copy an EDID follow the steps below.

1. Select an EDID from the **Select Source to Copy from** section. An EDID can be selected from a monitor connected to one of the outputs or from an EDID already loaded into one of the local memory locations (Input). It should be noted that only one EDID can be selected for copying.
2. Select the local memory locations that will receive the selected EDID under the **Select Input(s) to Copy to** section. Multiple local memory locations can be specified during this step.
3. Click on the **Set EDID** button to initiate the change(s).

This page will automatically refresh every minute. However, at anytime the **Refresh** button can be pressed to refresh the status of the Matrix.

NOTICE: UPLOAD EDID and DOWNLOAD EDID features are not supported at the time of this writing.

Manage EDID - EDID Lock State

The 8x8 DVI Dual Link Matrix with Push Button Controls allows the Local EDID to be preserved after the unit has been powered off. Once enabled, this will function will prevent the 8x8 DVI Dual Link Matrix with Push Button Controls from reading the EDID of a monitor, when the matrix is powered on.

The screenshot shows the Gefen 8x8 DL DVI Manager web interface. At the top, there is a navigation bar with buttons for VIEW MATRIX STATUS, MANAGE EDID (highlighted), MASKING, IP CONFIGURATION, BACKUP/RESTORE, and POWER MANAGEMENT. Below this is a secondary bar with buttons for SET INPUT TO DEFAULT EDID, UPLOAD EDID, DOWNLOAD EDID, COPY EDID, and EDID LOCK STATE (highlighted). The main content area is titled "EDID Lock State" and features a "Refresh" button, a table, and a radio button control. The table shows the EDID Status as "Lock State:OFF" and lists 8 inputs, all with "Default" EDID Source and "GEFEN_XPT_DL" Name. To the right of the table is a "Update EDID Lock State" button and two radio buttons, "Off" (selected) and "On". A second "Refresh" button is located at the bottom left of the table area.

Input	EDID Source	Name
1	Default	GEFEN_XPT_DL
2	Default	GEFEN_XPT_DL
3	Default	GEFEN_XPT_DL
4	Default	GEFEN_XPT_DL
5	Default	GEFEN_XPT_DL
6	Default	GEFEN_XPT_DL
7	Default	GEFEN_XPT_DL
8	Default	GEFEN_XPT_DL

The EDID Lock State can be enabled (ON) or disabled (OFF). The EDID Lock State is used.

1. Once the Local EDID has been stored, press the EDID LOCK STATE web button.
2. Select the ON radio button from the dialog and press Update EDID Lock State.

The 8x8 DVI Dual Link Matrix with Push Button Controls can be powered-down and the Local EDID will be preserved. To disable the EDID LOCK STATE feature, select the OFF radio button in the Web interface and press the Update EDID Lock State button. Once the EDID LOCK STATE has been disabled (OFF), the 8x8 DVI Dual Link Matrix with Push Button Controls will read and use the EDID of the monitor connected to the matrix.

Masking

Gefen 8x8 DL DVI Manager

VIEW MATRIX STATUS | MANAGE EDID | **MASKING** | IP CONFIGURATION | BACKUP/RESTORE | POWER MANAGEMENT

Refresh

Output	Input	Status
1	1	Masked
2	2	Active
3	1	Active
4	4	Active
5	5	Active
6	6	Active
7	7	Active
8	8	Active

Refresh

Mask Outputs

Outputs

Output 1 Active Mask Output 2 Active Mask Output 3 Active Mask Output 4 Active Mask

Output 5 Active Mask Output 6 Active Mask Output 7 Active Mask Output 8 Active Mask

Submit

The **Masking** page is used to hide an output from displaying any video. From this page, all outputs can be set to “Active” or “Mask”. When an output is set to “Active”, it will function normally. When an output is set to “Mask”, it will not output any video. To set the “Active” or “Mask” mode, follow the steps below.

1. Select either “Active” or “Mask” for any number of desired outputs.
2. Press the “Submit” button to initiate the change(s).

After this command is complete the user will be returned to the **Main Page**.

This page will automatically refresh every minute, however, at anytime the “Refresh” button can be pressed to refresh the status of the matrix.

NOTE: All masked outputs will become active if the unit is power-cycled.

IP CONTROL

IP Configuration

Gefen 8x8 DL DVI Manager

VIEW MATRIX STATUS MANAGE EDID MASKING **IP CONFIGURATION** BACKUP/RESTORE POWER MANAGEMENT

MAC Address	IP Address	Subnet	Gateway	Port
0:1C:91:1:20:0	192.168.2.26	225.225.225.0	192.168.0.1	80

Refresh

Change IP Settings

IP Address: (default: 192.168.0.70)
Subnet: (default: 255.255.255.0)
Gateway: (default: 192.168.0.1)
Port: (default: 80)

Save Reset IP Configuration to Defaults:

The **IP Configuration** page is used to set the IP settings that will be used to access the Web interface. The following items can be configured from this menu.

- IP Address (Default: 192.168.0.70)
- Subnet (Default: 255.255.255.0)
- Gateway (192.168.0.1)
- Port (Default: 80)

To change these settings follow the steps below.

1. Enter the desired network information into the fields provided.
2. Press the “Save” button to initiate the change(s).

Note: After this command is complete the user will be returned to the **Main Page**. Setting made on this page will not take effect until the unit is restarted. Please disconnect power from the unit and reconnect power for changes to take effect.

At anytime, the “Reset” button can be pressed to return the IP settings to their defaults.

IP CONTROL

Backup / Restore

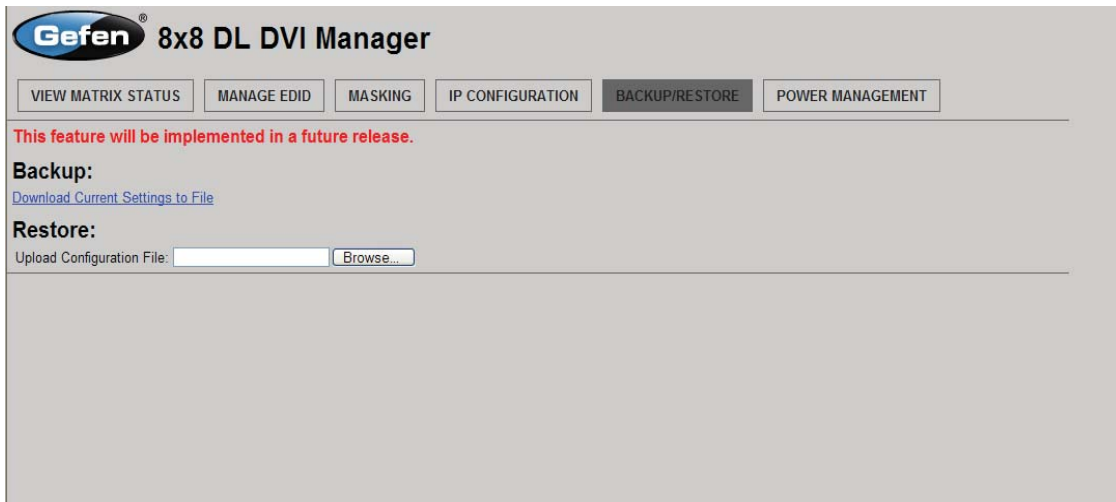

The **Backup/Restore** page is used to backup and restore complete setup configurations. This feature will be implemented in a future release.

Power Management

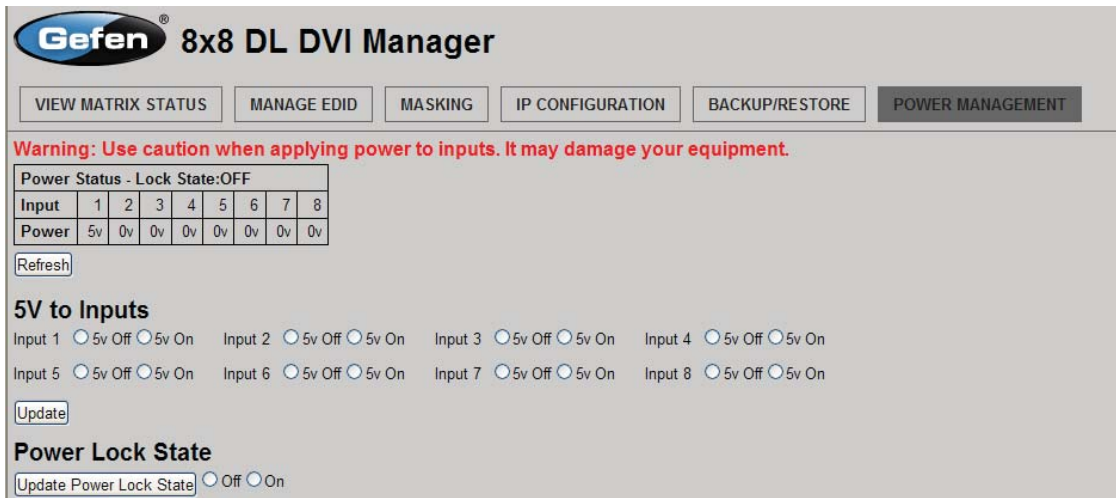

The **Power Management** page is used to set optional +5V power when using Gefen Fiber Optic Extenders. The current status of this feature for each input can be viewed on this page. To set this feature for each input follow the steps below.

1. Select the +5V option, either “On” or “Off” for each desired input.
2. Click on the “Update” button to initiate the change(s).

Note: After this command is complete the user will be returned to the **Main Page**.

This page will automatically refresh every minute, however, at anytime the “Refresh” button can be pressed to refresh the status of the matrix.

NETWORK CABLE WIRING DIAGRAM

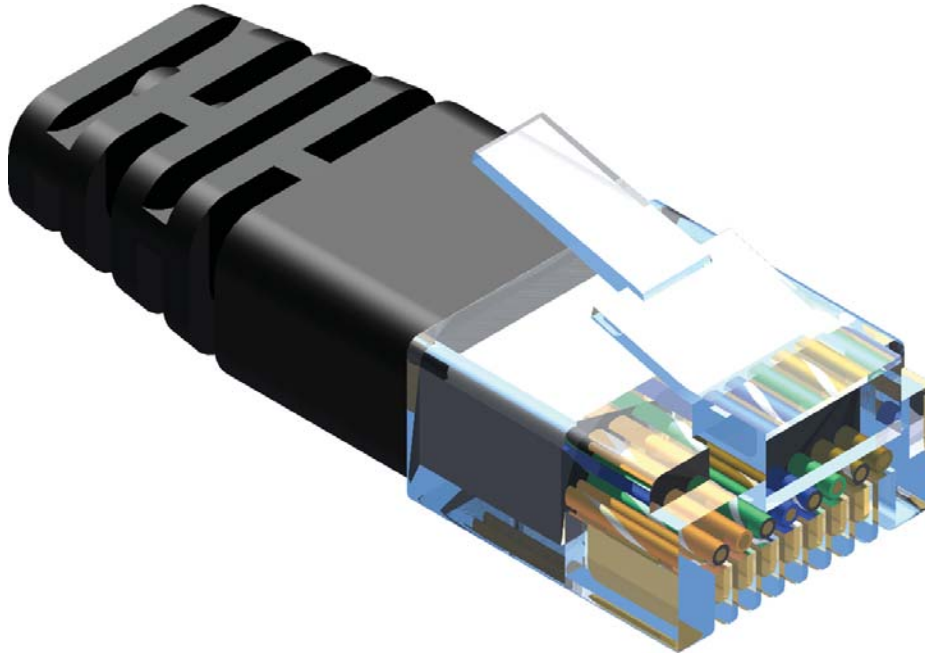

Gefen recommends the TIA/EIA-568-B wiring option. Please adhere to the table below when field-terminating the cable for use with Gefen products.

Pin	Color
1	Orange / White
2	Orange
3	Green / White
4	Blue
5	Blue / White
6	Green
7	Brown / White
8	Brown

Cabling comes in stranded and solid core types. Gefen recommends using solid core cabling.

It is recommended to use one continuous run from one end to the other. Connecting through a patch is not recommended.

FIRMWARE UPDATE

Firmware Update

Follow the on-screen instructions to complete the firmware update process:

1. Press [1] on the computer keyboard to begin downloading program to the temporary memory.

2. A message will appear in Hyperterminal:

```
Waiting for the file to be sent ... (press 'a' to abort)
```

3. In Hyperterminal, click Transfer > Send File...

4. Click Browse... and select the .BIN file to be uploaded (e.g. DVI8X8_uIP_1_7.bin)

5. Select Ymodem for the protocol.

6. Press Send on the Send File dialog box.

7. A message will appear in Hyperterminal:

```
Programming Completed Successfully!
```

RACK MOUNT SAFETY INFORMATION

- a. Maximum recommended ambient temperature: 45 °C (104 °F).
- b. Increase the air flow as needed to maintain the recommended temperature inside the rack.
- c. Do not exceed maximum weight loads for the rack. Install heavier equipment in the lower part of the rack to maintain stability.
- d. Connect a bonding wire between an approval safety ground stud on the chassis.

A

ADC

Apple Display Connector. The ADC interface is a proprietary interface developed by Apple that combines analog and digital signals, USB, and power in a single cable.

C

CAT-5

Category-5 cable, commonly known as Cat-5, is an unshielded twisted pair type cable designed for high signal integrity. The actual standard defines specific electrical properties of the wire, but it is most commonly known as being rated for its Ethernet capability of 100 Mbit/s. Its specific standard designation is EIA/TIA-568. Cat 5 cable typically has three twists per inch of each twisted pair of 24 gauge copper wires within the cable.

CAT-5e

Similar to Cat 5 cable, but is enhanced to support speeds of up to 1000 megabits per second.

CRT

An acronym for Cathode Ray Tube: a common type of computer display hardware.

D

DDC

Short form for Display Data Channel. It is a VESA standard for communication between a monitor and a video adapter. Using DDC, a monitor can inform the video card about its properties, such as maximum resolution and color depth. The video card can then use this information to ensure that the user is presented with valid options for configuring the display.

GLOSSARY

DDWG

An acronym for Digital Display Working Group. DDWG are the creators of the DVI specification.

Dolby Digital®

This is a digital surround sound technology used in movie theaters and upscale home theater systems that enhances audio. Home theater components with this technology work in conjunction with a “8.1-speaker” system (Eight speakers plus a low-frequency subwoofer) to produce true-to-life audio that draws the listener into the onscreen action.

DTS™

DTS is the acronym for Digital Theater Systems. DTS is a discrete 8.1 channel surround system similar to Dolby Digital. Dolby Digital is the DTV standard, but DTS competes with Dolby on DVD and in the movie theaters.

DVI

The acronym for Digital Visual Interface. DVI is the connection standard developed by Intel for connecting computers to digital monitors such as flat panels and DLP projectors. A consumer electronics version, not necessarily compatible with the PC version, is used as a connection standard for HDTV tuners and displays. Transmits an uncompressed digital signal to the display.

E

EDID

The acronym for Extended Display Identification Data. The EDID is a data structure provided by a digital display to describe its capabilities to a video source device. EDID is defined and standardized by the Video Electronics Standards Association (VESA). Among other things, the EDID includes manufacturer name, ID, serial number, product type, and timings supported by the display.

F

Fiber Optic

Refers to the medium and the technology associated with the transmission of information as light pulses along a glass or plastic wire or fiber. Optical fiber carries much more information than conventional copper wire and is in general not subject to electromagnetic interference and the need to retransmit signals.

H

HDCP

High-Bandwidth Digital Content Protection. Created by Intel, HDCP is used with HDTV signals over DVI and HDMI connections and on D-Theater D-VHS recordings to prevent unauthorized duplication of copy written material.

HDMI

The High-Definition Multimedia Interface (HDMI) is an industry-supported, uncompressed, all-digital audio/video interface. HDMI provides an interface between any compatible digital audio/video source, such as a set-top box, DVD player, and A/V receiver and a compatible digital audio and/or video monitor, such as a digital television (DTV).

HD-SDI

HD-SDI is the acronym for High-Definition Serial Digital Interface. HD-SDI provides a data rate of 1.485 Gb/s for high-definition video and audio.

HDTV

High-Definition Television. The high-resolution subset of our DTV system. The ATSC defines HDTV as a 16:9 image with twice the horizontal and vertical resolution of our existing system, accompanied by 5.1 channels of Dolby Digital audio. The CEA defines HDTV as an image with 720 progressive or 1080 interlaced active (top to bottom) scan lines. 1280 x 720p and 1920 x 1080i are typically accepted as high-definition scan rates.

I

IEEE 1394a

A type of cabling technology for transferring data to and from digital devices at high speed. Some professional digital cameras and memory card readers connect to the computer over FireWire. FireWire card readers are typically faster than those that connect via USB. Also known as IEEE 1394, FireWire was invented by Apple Computer but is now commonly used with Windows-based PCs as well.

IR remote

A type of wireless transmission using infrared light waves.

K

KVM

An acronym for Keyboard / Video / Mouse. A KVM switch is a hardware device that allows control of multiple computers from a single keyboard, video monitor and mouse.

L

LCD

Liquid Crystal Display. A display that consists of two polarizing transparent panels and a liquid crystal surface sandwiched in between. Voltage is applied to certain areas, causing the crystal to turn dark. A light source behind the panel transmits through transparent crystals and is mostly blocked by dark crystals.

N

NTSC

NTSC is an acronym for National Television Systems Committee. NTSC is the current analog television standard used in North America, most of South America, Burma, South Korea, Taiwan, Japan, and the Philippines.

P

PAL

An acronym for Phase Alternate Line. PAL is the analog television display standard that is used in Europe and certain other parts of the world. North America uses the NTSC standard. PAL typically uses 625 scan lines, compared to the NTSC standard of 525 scan lines.

PS/2

A serial interface developed by IBM for the purpose of connecting a keyboard or mouse to a PC. The PS/2 port has a mini DIN plug containing 6 pins. PS/2 ports are used so that the serial port can be used by another device.

R

RS-232

The acronym for Recommended Standard 232. RS-232 is the name for a series of standards for serial data and control signals frequently used by computers serial ports.

S

SDI

SDI is the acronym for Serial Digital Interface. SDI is used for standard definition applications (SMPTE 259M) with bit rates of 270 Mb/s, 360 Mb/s, 143 Mb/s, and 177 Mb/s. 270 Mb/s is the most common. Bit rates below 270 Mb/s were designed for the digital transmission of composite (NTSC or PAL) video.

SMPTE

The acronym for Society of Motion Picture and Television Engineers. SMPTE was founded in 1916 and is an international professional association, based in the U.S. SMPTE has over 400 standards and engineering guidelines for television, motion pictures, digital cinema, as well as audio and medical applications.

S/PDIF

S/PDIF is the acronym for Sony / Philips Digital Interconnect Format but is more commonly known as Sony / Philips Digital Interface. S/PDIF is a digital audio interface used in consumer audio equipment used to carry digital audio signals over a relatively short distance. The digital signal is transmitted over a coaxial cable with RCA connectors.

T

TOSLINK

TOSLINK is an abbreviated format of the two words *Toshiba Link*. TOSLINK is a standardized optical fiber connection system used to transmit digital audio between various pieces of consumer audio equipment. TOSLINK can support several different audio formats including LPCM, Dolby®, and DTS™.

U

USB

USB is an acronym for Universal Serial Bus. USB can connect computer peripherals such as mice, keyboards, digital cameras, printers, personal media players, flash drives, Network Adapters, and external hard drives. For the most part, USB has made interfaces such as serial and parallel ports obsolete.

V

VESA

VESA (Video Electronics Standards Association) is an international standards entity for computer graphics. The initial goal of VESA was to produce a standard for the 800 x 600 SVGA resolution displays. However, the VESA standard has produced several standards which relate to the function of video devices on personal computers. DisplayPort is also a VESA technology that supports connections to digital displays.

VGA

Video Graphics Array (VGA) initially refers to the display hardware which was introduced with the IBM PS/2 line of computers in 1987. However, it is also used to define the 15-pin D-subminiature VGA connector, as well as a resolution of 640 x 480.

SPECIFICATIONS

Video Amplifier Bandwidth.....	2 x 165 MHz
Input Video Signal.....	1.2 volts p-p
Input DDC Signal.....	5 volts p-p (TTL)
DVI Input Connectors.....	(8) DVI-I 29 pin female
DVI Output Connectors.....	(8) DVI-I 29 pin female
IR Extender.....	3.5 mm mini-stereo
RS-232 Interface.....	DB-9 female
IP Interface.....	RJ-45
Power Supply.....	100 ~ 240 V AC (IEC connector)
Power Consumption.....	70 Watts (max.)
Operating Temperature.....	0 °C ~ 45 °C / 32 °F ~ 113 °F
Storage Temperature.....	-20 °C ~ 60 °C / -4 °F ~ 140 °F
Relative Humidity.....	20% ~ 90% RH (no condensation)
Rack Size.....	2U
Dimensions.....	19.0" W x 3.5" H x 4.2" D
Shipping Weight.....	28.1 lbs.

WARRANTY

Gefen warrants the equipment it manufactures to be free from defects in material and workmanship.

If equipment fails because of such defects and Gefen is notified within two (2) years from the date of shipment, Gefen will, at its option, repair or replace the equipment, provided that the equipment has not been subjected to mechanical, electrical, or other abuse or modifications. Equipment that fails under conditions other than those covered will be repaired at the current price of parts and labor in effect at the time of repair. Such repairs are warranted for ninety (90) days from the day of reshipment to the Buyer.

This warranty is in lieu of all other warranties expressed or implied, including without limitation, any implied warranty or merchantability or fitness for any particular purpose, all of which are expressly disclaimed.

1. Proof of sale may be required in order to claim warranty.
2. Customers outside the US are responsible for shipping charges to and from Gefen.
3. Copper cables are limited to a 30 day warranty and cables must be in their original condition.

The information in this manual has been carefully checked and is believed to be accurate. However, Gefen assumes no responsibility for any inaccuracies that may be contained in this manual. In no event will Gefen be liable for direct, indirect, special, incidental, or consequential damages resulting from any defect or omission in this manual, even if advised of the possibility of such damages. The technical information contained herein regarding the features and specifications is subject to change without notice.

For the latest warranty coverage information, please visit Gefen's Warranty web page at <http://www.gefen.com/kvm/aboutus/warranty.jsp>

PRODUCT REGISTRATION

Please register your product online by visiting Gefen's web site at <http://www.gefen.com/kvm/Registry/Registration.jsp>

LICENSING

lwIP is licenced under the BSD licence:

Copyright (c) 2001-2004 Swedish Institute of Computer Science.
All rights reserved.

Redistribution and use in source and binary forms, with or without modification, are permitted provided that the following conditions are met:

1. Redistributions of source code must retain the above copyright notice, this list of conditions and the following disclaimer.
2. Redistributions in binary form must reproduce the above copyright notice, this list of conditions and the following disclaimer in the documentation and/or other materials provided with the distribution.
3. The name of the author may not be used to endorse or promote products derived from this software without specific prior written permission.

THIS SOFTWARE IS PROVIDED BY THE AUTHOR ``AS IS'' AND ANY EXPRESS OR IMPLIED WARRANTIES, INCLUDING, BUT NOT LIMITED TO, THE IMPLIED WARRANTIES OF MERCHANTABILITY AND FITNESS FOR A PARTICULAR PURPOSE ARE DISCLAIMED. IN NO EVENT SHALL THE AUTHOR BE LIABLE FOR ANY DIRECT, INDIRECT, INCIDENTAL, SPECIAL, EXEMPLARY, OR CONSEQUENTIAL DAMAGES (INCLUDING, BUT NOT LIMITED TO, PROCUREMENT OF SUBSTITUTE GOODS OR SERVICES; LOSS OF USE, DATA, OR PROFITS; OR BUSINESS INTERRUPTION) HOWEVER CAUSED AND ON ANY THEORY OF LIABILITY, WHETHER IN CONTRACT, STRICT LIABILITY, OR TORT (INCLUDING NEGLIGENCE OR OTHERWISE) ARISING IN ANY WAY OUT OF THE USE OF THIS SOFTWARE, EVEN IF ADVISED OF THE POSSIBILITY OF SUCH DAMAGE.



20600 Nordhoff St., Chatsworth CA 91311
1-800-545-6900 818-772-9100 fax: 818-772-9120
www.gefenpro.com support@gefenpro.com

