



**4K ULTRA HD**  
60Hz, 4:2:0

**Extender w/ POL and 2-way IR**

GTB-HDBT-POL-BLK

User Manual



Release A9

# Important Safety Instructions

1. Read these instructions.
2. Keep these instructions.
3. Heed all warnings.
4. Follow all instructions.
5. Do not use this product near water.
6. Clean only with a dry cloth.
7. Do not block any ventilation openings. Install in accordance with the manufacturer's instructions.
8. Do not install or place this product near any heat sources such as radiators, heat registers, stoves, or other apparatus (including amplifiers) that produce heat.
9. Do not defeat the safety purpose of the polarized or grounding-type plug. A polarized plug has two blades with one wider than the other. A grounding type plug has two blades and a third grounding prong. The wide blade or the third prong are provided for your safety. If the provided plug does not fit into your outlet, consult an electrician for replacement of the obsolete outlet.
10. Protect the power cord from being walked on or pinched particularly at plugs, convenience receptacles, and the point where they exit from the apparatus.
11. Only use attachments/accessories specified by the manufacturer.
12. To reduce the risk of electric shock and/or damage to this product, never handle or touch this unit or power cord if your hands are wet or damp. Do not expose this product to rain or moisture.
13. Unplug this apparatus during lightning storms or when unused for long periods of time.
14. Refer all servicing to qualified service personnel. Servicing is required when the apparatus has been damaged in any way, such as power-supply cord or plug is damaged, liquid has been spilled or objects have fallen into the apparatus, the apparatus has been exposed to rain or moisture, does not operate normally, or has been dropped.
15. Batteries that may be included with this product and/or accessories should never be exposed to open flame or excessive heat. Always dispose of used batteries according to the instructions.

# Warranty Information

Gefen warrants the equipment it manufactures to be free from defects in material and workmanship.

If equipment fails because of such defects and Gefen is notified within two (2) years from the date of shipment, Gefen will, at its option, repair or replace the equipment, provided that the equipment has not been subjected to mechanical, electrical, or other abuse or modifications. Equipment that fails under conditions other than those covered will be repaired at the current price of parts and labor in effect at the time of repair. Such repairs are warranted for ninety (90) days from the day of reshipment to the Buyer.

This warranty is in lieu of all other warranties expressed or implied, including without limitation, any implied warranty or merchantability or fitness for any particular purpose, all of which are expressly disclaimed.

1. Proof of sale may be required in order to claim warranty.
2. Customers outside the US are responsible for shipping charges to and from Gefen.
3. Copper cables are limited to a 30 day warranty and cables must be in their original condition.

The information in this manual has been carefully checked and is believed to be accurate. However, Gefen assumes no responsibility for any inaccuracies that may be contained in this manual. In no event will Gefen be liable for direct, indirect, special, incidental, or consequential damages resulting from any defect or omission in this manual, even if advised of the possibility of such damages. The technical information contained herein regarding the features and specifications is subject to change without notice.

For the latest warranty coverage information, refer to the Warranty and Return Policy under the Support section of the Gefen Web site at [www.gefen.com](http://www.gefen.com).

## Technical Support

(818) 772-9100      (800) 545-6900  
8:00 AM to 5:00 PM Monday - Friday, Pacific Time

## Fax

(818) 772-9120

## Email

support@gefen.com

## Web

<http://www.gefen.com>

## Mailing Address

Gefen, LLC  
c/o Customer Service  
20600 Nordhoff St.  
Chatsworth, CA 91311

## Product Registration

Register your product here: <http://www.gefen.com/kvm/Registry/Registration.jsp>

# Operating Notes

- Shielded CAT-5e cables should not exceed 198 feet (60 meters) and CAT-6 cables should not exceed 230 feet (70 meters). For the best performance, keep these cables away from electromagnetic sources.
- POL (Power Over Line) technology from Gefen sends power to the Receiver unit over the same shielded CAT-5e (or better) cable that is used for extending the HDMI signal.
- HDBaseT® technology allows HDMI, IR (bidirectional), and power to be sent over a single shielded CAT-5e / CAT-6 cable.
- The **IR In** port, on the Sender unit, is designed to accept an electrical IR connection from third-party automation devices. It will not work with Gefen IR extenders.
- The **IR Ext** port, on the Receiver unit, is designed to work with the Gefen EXT-RMT-EXTIRN extender. It will not work with the electrical IR connection from an automation control device.

**4K Ultra HD Extender w/ POL and 2-way IR** is a trademark of Gefen, LLC.

© 2015 Gefen, LLC. All Rights Reserved. All trademarks are the property of their respective owners.

Gefen, LLC reserves the right to make changes in the hardware, packaging, and any accompanying documentation without prior written notice.



This product uses UL listed power supplies.

## Features

- Extends 4K Ultra HD (3840 x 2160 @ 60 Hz 4:2:0, or 30 Hz, 4:4:4) and Bi-Directional IR up to 130 feet (40 meters) over a single CAT-5e cable (8-bit color)
- Extends 4K Ultra HD (4096 x 2160 @ 24 or 30 Hz 4:4:4) and Bi-Directional IR up to 130 feet (40 meters) over a single CAT-5e or CAT-6 cable
- Extends HDMI at 1080p Full HD and Bi-Directional IR up to 230 feet (70 meters) over a single CAT-6 cable, or up to 198 feet (60 meters) over CAT-5e
- HDMI Features Supported:
  - ▶ HDCP 2.2 and 1.4
  - ▶ 12-bit Deep Color
  - ▶ LPCM 7.1 audio, Dolby® TrueHD, Dolby Digital® Plus, and DTS-HD Master Audio™
  - ▶ 3DTV pass-through
  - ▶ CEC pass-through
  - ▶ Lip Sync pass-through
- Bi-Directional IR extension
- Gefen POL feature provides power to the Receiver unit over the CAT-5e
- Uses HDBaseT™ technology
- Locking power connector
- Easy surface mounting



## Packing List

The following items are shipped with the 4K Ultra HD Extender w/ POL and 2-way IR. If any of these items are not present in the box when you first open it, immediately contact your dealer or Gefen.

- 1 x 4K Ultra HD Extender w/ POL and 2-way IR (Sender unit)
- 1 x 4K Ultra HD Extender w/ POL and 2-way IR (Receiver unit)
- 1 x 6 ft. locking HDMI cable (M-M)
- 1 x IR extender
- 1 x IR emitter
- 1 x 24V DC locking power supply
- 1 x Quick-Start Guide



### Information

The Extender for HDMI w/ POL ships with one IR emitter. However, depending upon the application, a secondary IR emitter may need to be purchased. See IR Control (page 11) for more information on using IR control.

## 1 Getting Started

Introduction.....	2
Sender unit.....	2
Receiver unit .....	4
Installation .....	6
Connection Instructions.....	6
Sample Wiring Diagram .....	7

## 2 Basic Operation

Power LED Status .....	10
IR Control .....	11
Controlling the Source from the Viewing Location .....	11
Controlling the Display from the Source Location .....	12

## 3 Appendix

Surface Mounting Instructions.....	16
Network Cable Diagram .....	17
Specifications .....	18







**4K ULTRA**   
60Hz, 4:2:0

Extender w/ POL and 2-way IR

1 Getting Started

Sender unit

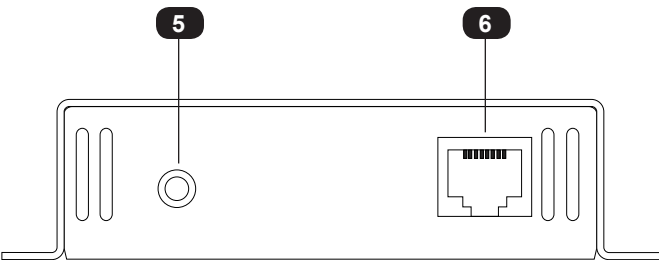
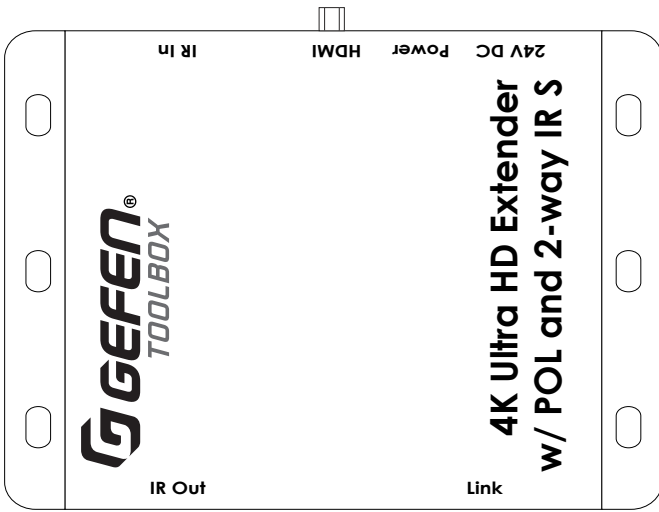
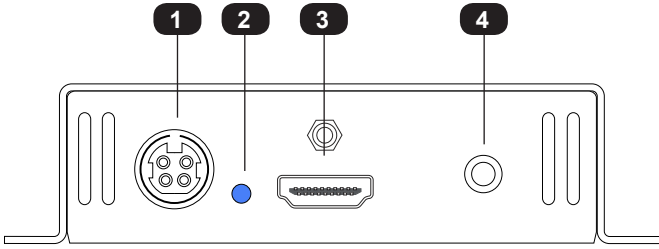

ID	Name	Description
1	24V DC	Connect the included 24V DC power supply to this power receptacle.
2	Power	This LED indicator will glow bright blue and will remain illuminated as long as the power supply is connected to the Sender unit. See <a href="#">Power LED Status (page 10)</a> for more information on LED status messages.
3	HDMI	Use the included HDMI cable to connect an Ultra Hi-Def source to this HDMI port.
4	IR In	Connect a mini-mono 3.5mm cable from this port to an automation system with an electrical IR output. It will not work with Gefen IR extenders.
5	IR Out	Connect the included IR emitter from this port to the IR sensor of the device to be controlled.
6	Link	Connect a shielded CAT-5e cable (or better) from this port to the <b>Link</b> port on the Receiver unit. See <a href="#">Connection Instructions (page 6)</a> for information on resolutions, cable type, and distance.

## Receiver unit

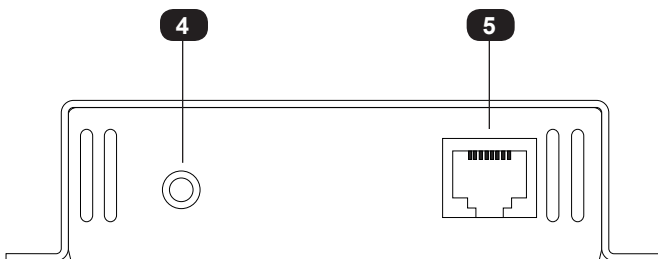
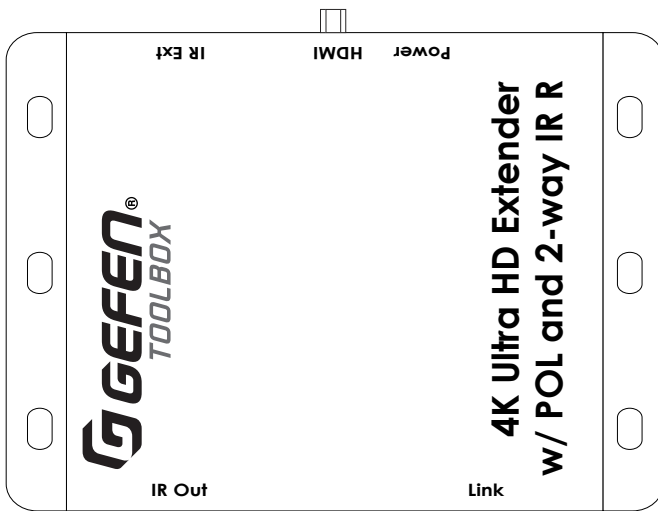
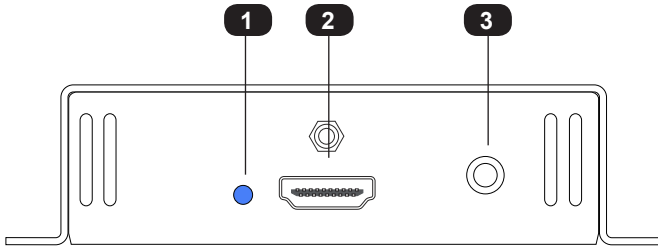

ID	Name	Description
1	Power	This LED indicator will glow bright blue and will remain illuminated as long as the power supply is connected to the Receiver unit. See <a href="#">Power LED Status (page 10)</a> for more information on LED status messages.
2	HDMI	Connect an HDMI cable between this port and an Ultra HD display.
3	IR Ext	Connect the included IR extender to this port. It will not work with the electrical IR connection from an automation control device.
4	IR Out	Connect an IR emitter (Gefen part no. EXT-IREMIT) from this port to the IR sensor of the device to be controlled.
5	Link	Connect a shielded CAT-5e cable (or better) from this port to the <b>Link</b> port on the Sender unit. See <a href="#">Connection Instructions (page 6)</a> for information on resolutions, cable type, and distance.

## Connection Instructions

### ▶ Video

1. Connect the included HDMI cable between the Ultra HD source and the **HDMI** port on the Sender unit.
2. Connect an Ultra HD display to the **HDMI** port on the Receiver unit using another HDMI cable.

### ▶ Network cable

3. Connect a shielded CAT-5e or CAT-6 cable from the **Link** jack on the Sender unit to the **Link** jack on the Receiver unit:

Resolution	Cable type	Distance
4K Ultra HD (3840 x 2160) <ul style="list-style-type: none"> <li>• 60 Hz @ 4:2:0</li> <li>• 30 Hz @ 4:4:4</li> </ul>	CAT-5e (or better)	130 feet (40 meters) 8-bit color, only
4K Ultra HD (4096 x 2160) <ul style="list-style-type: none"> <li>• 30 Hz @ 4:4:4</li> </ul>	CAT-5e (or better)	130 feet (40 meters)
1080 Full HD (1920 x 1080) <ul style="list-style-type: none"> <li>• 60 Hz @ 4:4:4</li> </ul>	CAT-5e (or better)	198 feet (60 meters) using CAT-5e  230 feet (70 meters) using CAT-6



### Information

If terminating network cables in the field, please adhere to the TIA/EIA568B specification. See [Network Cable Diagram \(page 17\)](#) for more information.

### ▶ IR

4. Refer to [IR Control \(page 11\)](#) for details on connecting IR devices.

### ▶ Power

5. Connect the included 24V DC power supply to the Sender unit and plug the AC power cord into an available electrical outlet. Power to the Receiver unit is delivered from the Sender unit over the CAT-5e/CAT-6 cable using Gefen POL technology.



## Sample Wiring Diagram

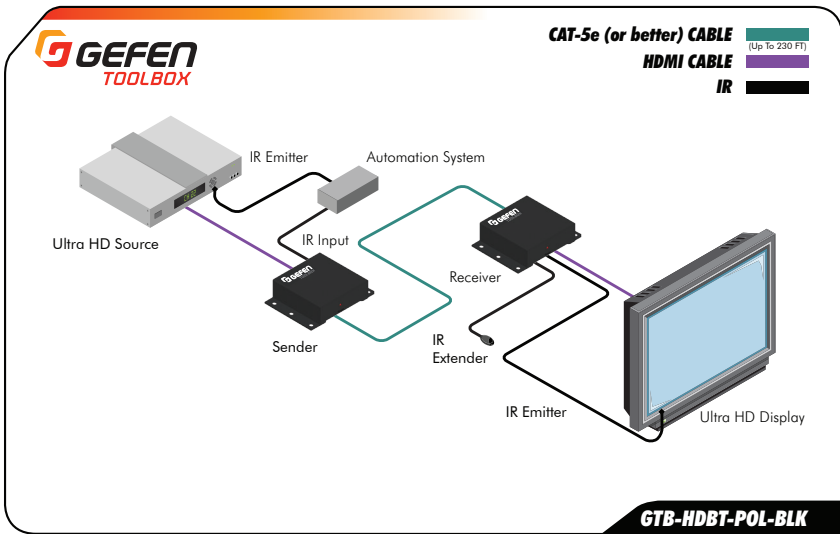

## Information

The wiring diagram, shown above, requires an additional IR emitter (Gefen part no. EXT-IREMIT).



**4K ULTRA**   
60Hz, 4:2:0



Extender w/ POL and 2-way IR

2

Basic Operation

# Power LED Status

The Power LED indicator on the Sender and Receiver unit provides basic information on the current status of the Extender for HDMI w/ POL.

LED	Status	Description
Power	Solid blue 	<ul style="list-style-type: none"><li>Power connected to Sender unit.</li></ul>
	Off 	<ul style="list-style-type: none"><li>No power supplied to the Sender or Receiver unit.</li><li>Make sure the power supply is connected to the Sender unit.</li><li>Make sure that the outlet is "live".</li><li>If the Sender unit LED is illuminated and Receiver unit LED is off, inspect the CAT-5e / CAT-6 cable between the Sender and Receiver unit.</li></ul>
	Flashing blue and amber 	<ul style="list-style-type: none"><li>Non-HDCP content is being transmitted from the source device.</li></ul>

## Controlling the Source from the Viewing Location



### Important

The **IR Ext** port, on the Receiver unit, is designed to work with the Gefen EXT-RMT-EXTIRN extender. It will not work with the electrical IR connection from an automation control device.

1. Connect the included IR extender to the **IR Ext** port on the Receiver unit.
2. Connect the included IR emitter from the **IR Out** port on the Sender unit to the IR sensor on the source device.

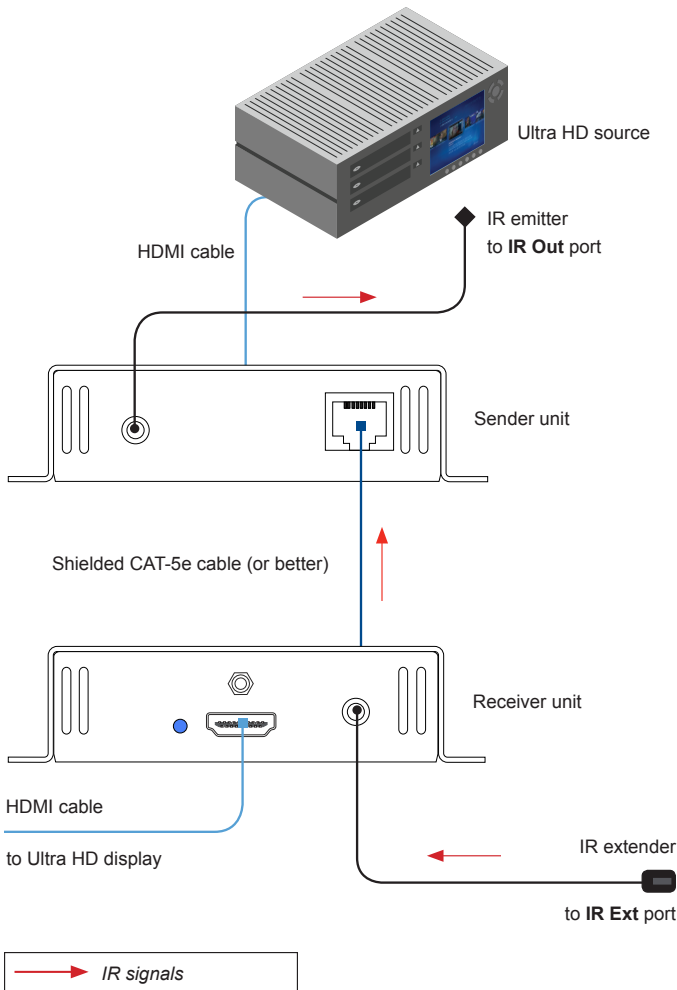

## Controlling the Display from the Source Location



### Important

The **IR In** port, on the Sender unit, is designed to accept an electrical IR connection from third-party automation devices. It will not work with Gefen IR extenders.

1. Connect the 3.5mm connector from the **IR In** port on the Sender unit to an automation system with electrical IR output.
2. Connect the included IR emitter from the **IR Out** port on the Receiver unit to the IR sensor on the display.

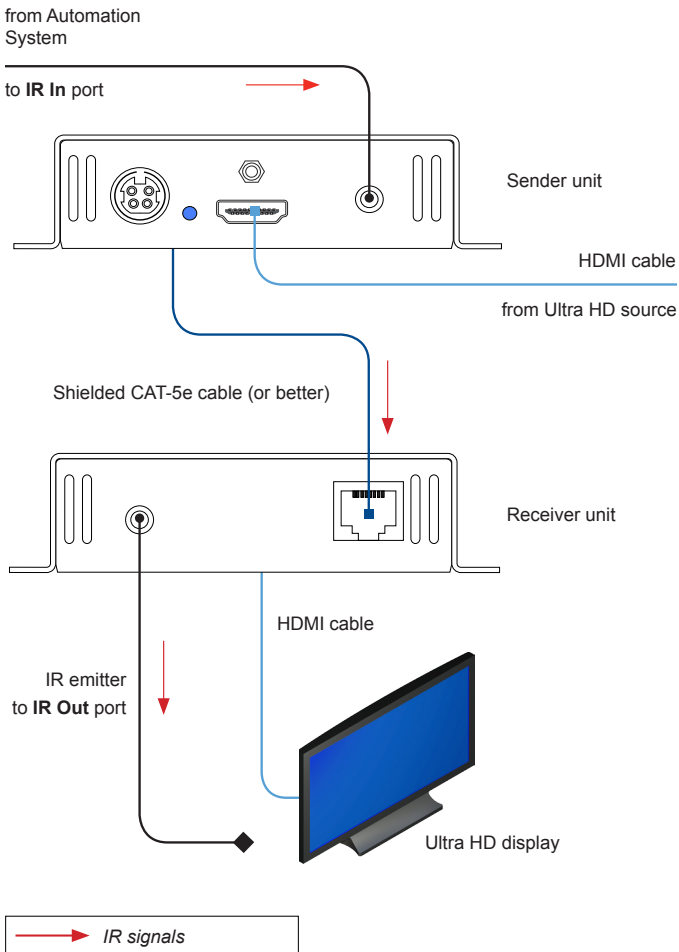







**4K ULTRA**   
60Hz, 4:2:0

Extender w/ POL and 2-way IR

**3** Appendix

# Surface Mounting Instructions

The Sender and Receiver units can be mounted on any flat surface, as shown below (screws not included). There should be an inch or two of clearance between the edges of the unit and any walls or vertical surfaces to allow for enough clearance for connection and disconnection of the HDMI cables.

For installation on a drywall surface, use a #6 drywall screw. When installing, it is recommended to use the center hole on a stud.

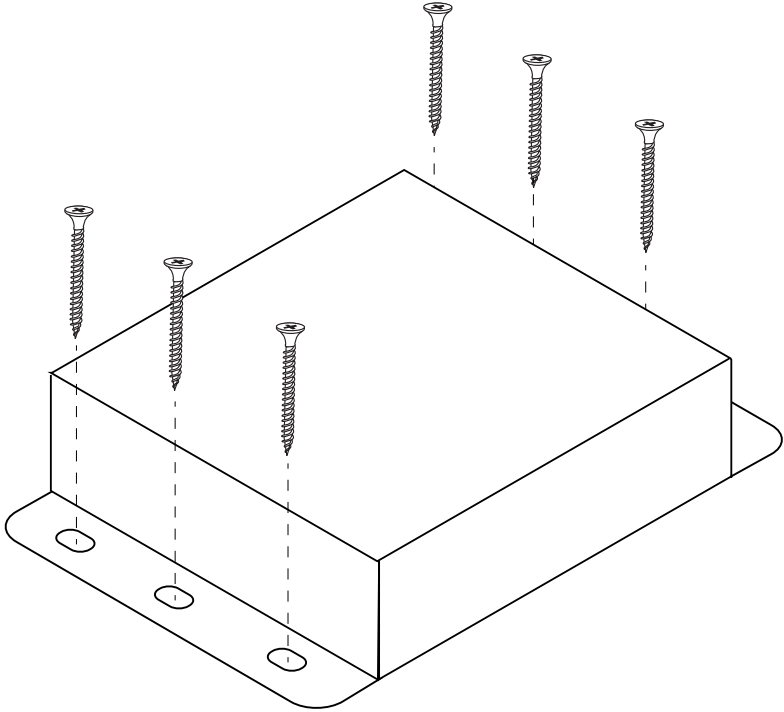

Front of RJ-45 Connector

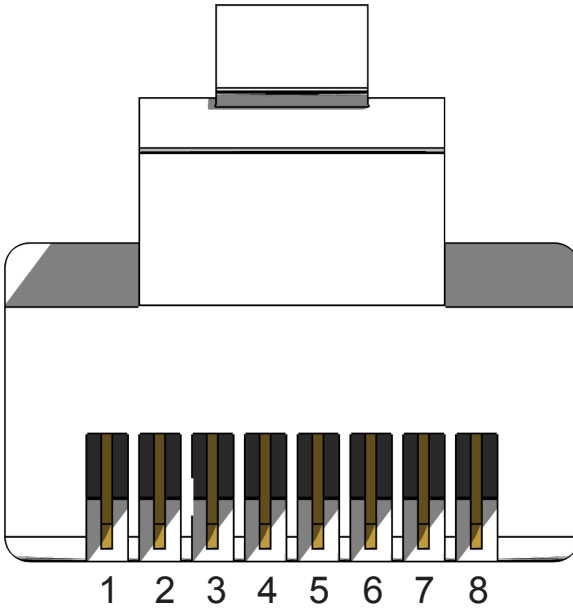

Gefen recommends the TIA/EIA-568-B wiring option. Use the following table when terminating cables in the field.

Pin	Color	Description
1	Orange / White	TD+ (Transmit Data, positive differential signal)
2	Orange	TD- (Transmit Data, negative differential signal)
3	Green / White	RD+ (Receive Data, positive differential signal)
4	Blue	Unused
5	Blue / White	Unused
6	Green	RD- (Receive Data, negative differential signal)
7	Brown / White	Unused
8	Brown / White	Unused



### Information

Shielded CAT-5e (or better) cabling is recommended.

## Supported Formats

Video	<ul style="list-style-type: none"> <li>• 4K x 2K (Ultra HD)</li> <li>• 1080p Full HD</li> </ul>
Audio	<ul style="list-style-type: none"> <li>• 7.1 Linear PCM</li> <li>• Dolby® TrueHD</li> <li>• DTS-HD Master Audio™</li> </ul>

## Connectors, Indicators, and Controls

HDMI (Sender)	<ul style="list-style-type: none"> <li>• 1 x HDMI Type A, 19-pin, female</li> </ul>
HDMI (Receiver)	<ul style="list-style-type: none"> <li>• 1 x HDMI Type A, 19-pin, female</li> </ul>
Link (Sender / Receiver)	<ul style="list-style-type: none"> <li>• 1 x RJ-45, shielded, female</li> </ul>
IR In (Sender)	<ul style="list-style-type: none"> <li>• 1 x 3.5mm mini-mono</li> </ul>
IR Out (Sender / Receiver)	<ul style="list-style-type: none"> <li>• 1 x 3.5mm mini-mono</li> </ul>
IR Ext (Receiver)	<ul style="list-style-type: none"> <li>• 1 x 3.5mm mini-stereo</li> </ul>
Power Indicator (Sender / Receiver)	<ul style="list-style-type: none"> <li>• 1 x LED, blue</li> </ul>
Power Receptacle (Sender)	<ul style="list-style-type: none"> <li>• 1 x 3-pin, locking</li> </ul>

## Operational

Maximum Pixel Clock	<ul style="list-style-type: none"> <li>• 300 MHz</li> </ul>
Maximum TMDS Clock	<ul style="list-style-type: none"> <li>• 300 MHz</li> </ul>
Power Input	<ul style="list-style-type: none"> <li>• 24V DC</li> </ul>
Power Consumption	<ul style="list-style-type: none"> <li>• 24 Watts (max.)</li> </ul>

## Physical

Dimensions (W x H x D) (Sender / Receiver)	<ul style="list-style-type: none"> <li>• 4.3" x 1" x 3.2" (110mm x 26mm x 80mm)</li> </ul>
Unit Weight	<ul style="list-style-type: none"> <li>• 0.33 lb (0.15 kg)</li> </ul>





20600 Nordhoff St., Chatsworth CA 91311  
1-800-545-6900 818-772-9100 fax: 818-772-9120  
[www.gefen.com](http://www.gefen.com) [support@gefen.com](mailto:support@gefen.com)