

Gefen TOOLBOX

Extender for HDMI w/POL

GTB-HDBT-POL
GTB-HDBT-POL-BLK

User Manual

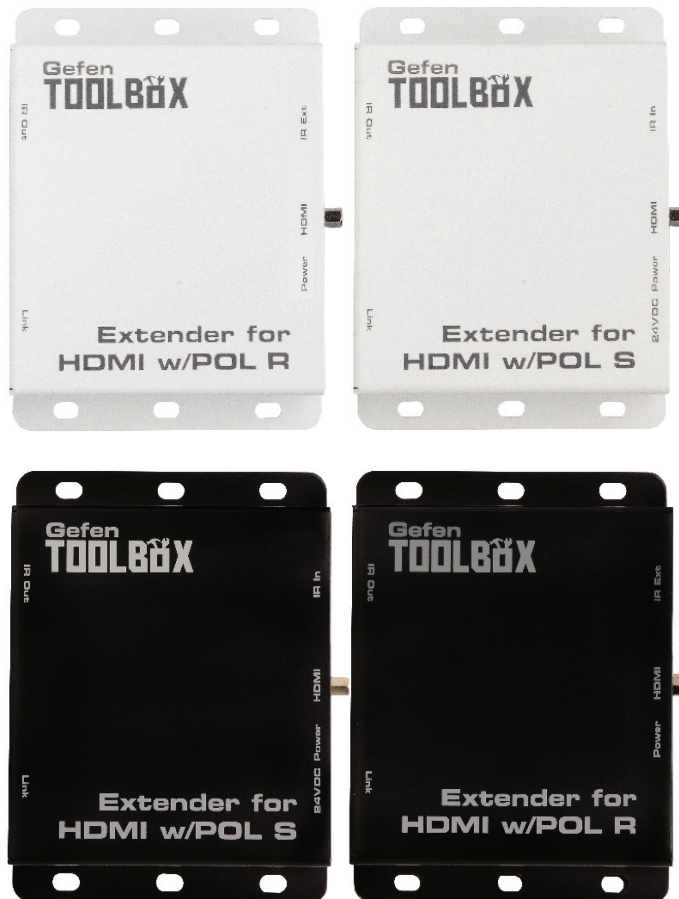

gefentoolbox.com

ASKING FOR ASSISTANCE

Technical Support:

Telephone (818) 772-9100
(800) 545-6900

Fax (818) 772-9120

Technical Support Hours:

8:00 AM to 5:00 PM Monday through Friday, Pacific Time

Write To:

Gefen, LLC.
c/o Customer Service
20600 Nordhoff St
Chatsworth, CA 91311

www.gefentoolbox.com
support@gefentoolbox.com

Notice

Gefen, LLC reserves the right to make changes in the hardware, packaging, and any accompanying documentation without prior written notice.

Extender for HDMI w/POL is a trademark of Gefen, LLC

HDMI, the **HDMI** logo, and **High-Definition Multimedia Interface** are trademarks or registered trademarks of HDMI Licensing in the United States and other countries.

© 2012 Gefen, LLC. All rights reserved.
All trademarks are the property of their respective owners.

Rev A2

CONTENTS

- 1 Introduction
- 2 Operation Notes
- 3 Features
- 4 Sender Unit Layout
- 5 Sender Unit Descriptions
- 6 Receiver Unit Layout
- 7 Receiver Unit Descriptions
- 8 Connecting the Extender for HDMI w/POL
 - 8 Wiring Diagram
- 9 Bi-Directional IR (Controlling the Source)
- 11 Bi-Directional IR (Controlling the Display)
- 13 Network Cable Wiring Diagram
- 14 Wall Mounting Instructions
- 15 Specifications
- 16 Warranty

INTRODUCTION

Congratulations on your purchase of the Extender for HDMI w/POL.
Your complete satisfaction is very important to us.

About Gefen

We specialize in total integration for your home theater, while also focusing on going above and beyond customer expectations to ensure you get the most from your hardware. We invite you to explore our distinct product line. Please visit <http://www.gefen.com> for the latest offerings in High-Definition signal solutions or call us between the hours of 8:00 am and 5:00 pm Monday-Friday, Pacific Standard Time for assistance with your A/V needs. We'll be happy to assist you.

The GefenToolBox Extender for HDMI w/POL

The GefenToolBox Extender for HDMI with POL extends HDMI up to 230 feet (70 meters) using one CAT-6 cable or up to 198ft (60m) using one CAT-5e. Resolutions up to 1080p Full HD with multichannel digital audio are supported. This product provides Bi-Directional IR extension between the Sender and the Receiver unit, allowing the transfer of IR commands from one remote location to the other. Bi-Directional IR can be used to control A/V sources placed near the Sender unit and to send IR automation commands to devices placed near the Receiver unit. Gefen POL (Power Over Line) technology powers the Receiver unit using the same CAT-5e or CAT-6 cable that extends the HDMI signal from the Sender unit. This feature eliminates the need for an external power supply at the Receiver unit which helps simplify installation.

How It Works

Connect the Sender unit to the Hi-Def source using an HDMI cable. Use another HDMI cable to connect the Receiver unit to the HDTV display. Connect a single CAT-6 cable up to 230 feet (70 meters) or CAT-5e cable up to 198ft (60m) between the Sender and Receiver units. Connect the included 24V DC power supply to the Sender unit and plug the power supply in to an available electrical outlet. Power to the Receiver unit is delivered from the Sender unit over the CAT-5e/6 cable using Gefen POL technology.

To control the Hi-Def source from the display location, connect the IR Extender (Gefen part no. EXT-RMT-EXTIRC) to the Ext IR connector on the Receiver unit. Connect the IR emitter (Gefen part no. GTB-IREMIT) to the IR Out of the Sender unit and place the IR emitter over the IR sensor of the Hi-Def source. Point the IR remote at the IR Extender to control the Hi-Def source.

For IR control of a device placed near the Receiver unit (such as the display), connect the IR output from an automation device (such as the Gefen PACS or Mini PACS) to the IR In connector on the Sender unit. Connect the IR emitter (Gefen part no. GTB-IREMIT) to the IR Out on the Receiver unit and attach the IR emitter to the IR sensor of the display.

OPERATION NOTES

READ THESE NOTES BEFORE INSTALLING OR OPERATING THE EXTENDER FOR HDMI W/POL

- CAT-5e or CAT-6 cables should not exceed 230 feet (70 meters).
- Shielded (STP) CAT-5 or CAT-6 is recommended. However, unshielded (UTP) CAT-5 or CAT-6 is acceptable, depending on cable quality, but is not the top choice. Care should always be given to keep these cables away from power lines and other electromagnetic interference sources.



NOTE: Shielded cable has an advantage by providing immunity to Electromagnetic Interference (EMI) from cell phones and A/C motors.

- POL (Power Over Line) technology from Gefen sends power to the Receiver uni over the same CAT-5e/6 cable that is used for extending the HDMI signal.
- HDBaseT[®] technology allows HDMI, IR (Bi-directional), and power to be sent on one CAT-5e/6 cable.

FEATURES

HDMI Features Supported

- Resolutions up to 1080p Full HD
- 12-bit Deep Color
- LPCM 7.1 audio, Dolby® TrueHD, Dolby Digital® Plus, and DTS-HD® Master Audio™
- 3DTV pass-through
- CEC pass-through
- Lip Sync pass-through

Features

- Extends HDMI and 3DTV up to 230 feet (70 meters) over a single CAT-6 or up to 198ft (60 meters) over a single CAT-5e
- Bi-Directional IR remote control of source device and the display
- Gefen POL feature provides power to the Receiver unit over the CAT-6
- Uses HDBaseT® technology
- Locking power connector
- Easy surface mounting
- Available in Black and White finishes

Package Includes

- (1) Extender for HDMI w/POL - Sender unit
- (1) Extender for HDMI w/POL - Receiver unit
- (1) 6 ft. Locking HDMI cable (M-M)
- (1) Single Infrared Emitter
- (1) IR Extender with Carrier Frequency
- (1) 24V DC Locking Power Supply
- (1) Set of Mounting Plates (Attached)
- (1) Quick Start Guide

SENDER UNIT LAYOUT

Front



Back

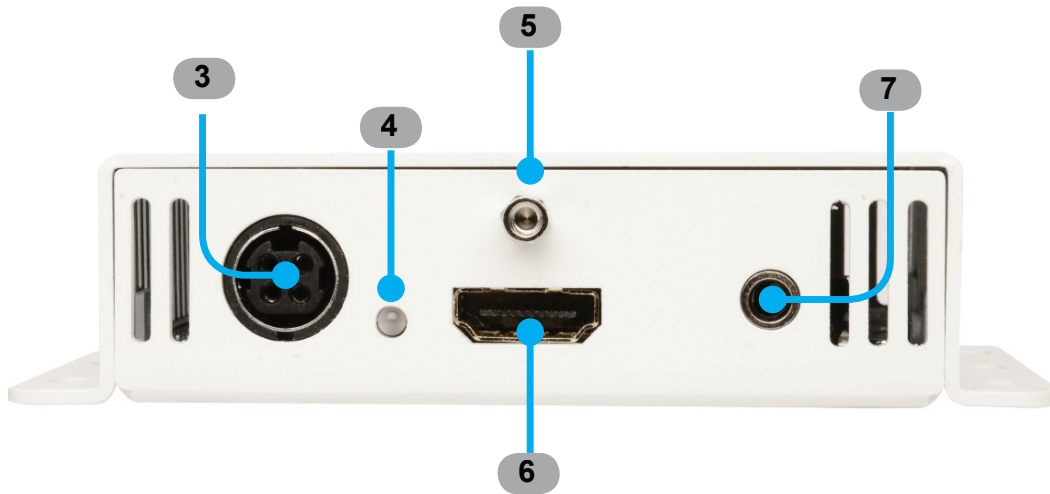

SENDER UNIT DESCRIPTIONS

1 IR Out

Connect the included single infrared IR emitter (Gefen part no. GTB-IREMIT) from this jack to the IR sensor window of the source.

2 Link

Connect a CAT-5e/CAT-6 cable from the Sender to the Receiver unit

3 24V DC

Connect the included 24V DC power supply to this connector and plug the AC power cord into an available electrical outlet. Only use the power supply shipped with this unit.

4 Power/HDCP Indicator

This LED will turn on once the included 24V DC power supply has been connected. If HDCP is present, the LED will be lit in solid blue. If HDCP is not detected, the LED will flash blue/amber.

5 HDMI Locking Connector

Used to lock the HDMI cable in place

6 HDMI Input

Connect a Hi-Def source to this port using the included locking HDMI cable. Please see the Features section on page 3 for supported HDMI features.

7 IR In

Connect a mono or stereo 3.5mm-to-3.5mm cable from this jack to one of the IR Emitter jacks on the Gefen PACS or Gefen Mini PACS. IR Emitters or IR Extenders will not function if connected to this port.

RECEIVER UNIT LAYOUT

Front



Back

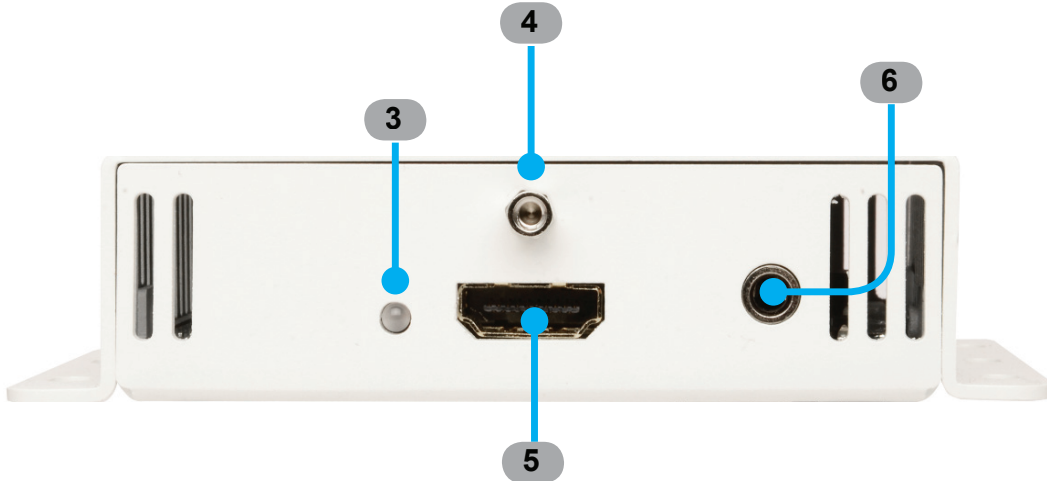

RECEIVER UNIT DESCRIPTIONS

1 IR Out

Connect a single infrared IR emitter (Gefen part no. GTB-IREMIT) from this jack to the IR sensor window of the HDTV display.

2 Link

Connect a CAT-5e/CAT-6 cable from the Sender to the Receiver unit

3 Power/HDCP Indicator

This LED will turn on once the included 24V DC power supply has been connected. If HDCP is present, the LED will be lit in solid blue. If HDCP is not detected, the LED will flash blue/amber.

4 HDMI Locking Connector

Used to lock the HDMI cable in place

5 HDMI Output

Connect an HDTV display to this port using a locking HDMI cable

6 IR EXT

Connect the included IR extender (Gefen part no. EXT-RMT-EXTIRC) to this jack

CONNECTING THE EXTENDER FOR HDMI W/POL

How to Connect the Extender for HDMI w/POL

1. Using the included locking HDMI cable, connect a Hi-Def source to the **HDMI Input port** on the Sender unit.
2. Connect an HDTV display to the **HDMI Output port** on the Receiver unit using another HDMI cable.
3. Connect a CAT-6 cable from the **Link jack** on the Sender unit to the **Link jack** on the Receiver unit up to 230 feet (70 meters). A CAT-5e cable can be used to extend up to 198 feet (70 meters).



NOTE: If terminating network cables in the field, please adhere to the TIA/EIA568B specification (see page 9).

4. IR Control: For details on using the Bi-directional IR feature, see page 9.
5. Connect the included 24V DC power supply to the Sender unit and plug the AC power cord into an available electrical outlet. Power to the Receiver unit is delivered from the Sender unit over the CAT-5e/CAT-6 cable using Gefen POL technology.
6. The LED's (on both the Sender and Receiver units) will turn on, indicating that both units are powered. IF HDCP is present, the LED will be lit in solid blue. IF HDCP is not detected, the LED's will flash blue/amber.

Wiring Diagram for the Extender for HDMI w/POL

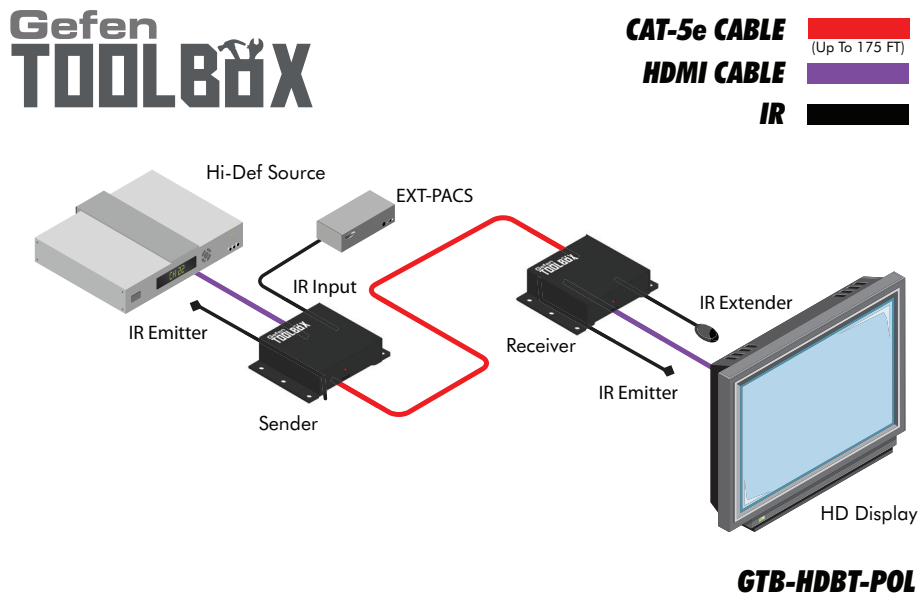

CONNECTING AND OPERATING THE EXTENDER FOR HDMI W/POL

How to Connect the Bi-Directional IR

Bi-Directional IR

The Bi-Directional IR feature allows two simultaneous methods of control: Control of the source device and control of the display.

The source device can be controlled from the viewing location by connecting an IR Extender (Gefen part no. EXT-RMT-EXTIRC) to the Receiver unit.

The display can be controlled from the source location by connecting a PACS / Mini PACS to the Sender unit.

Controlling the Source

In the example below, we will be setting up IR control for the source from the display location. The following illustrations assume all A/V devices have already been connected. **See page 8 for details.**

1. For IR control of a source, connect the IR extender to the **IR Ext jack** on the Receiver unit. A CAT-5e/CAT-6 cable should already be connected from the **Link jack** on the Receiver to the **Link jack** on the Sender unit.



Connect the IR extender to the IR Ext jack.

2. Connect an IR emitter from the **IR Out jack** on the Sender unit to the IR sensor window of the source device to be controlled.



Connect an IR emitter to the IR Out jack.

CONNECTING AND OPERATING THE EXTENDER FOR HDMI W/POL

3. To control the source from the display location, point the included IR remote control at the IR Extender connected to the Receiver unit. The IR signals are transmitted from the Receiver to the Sender unit over the CAT-5e/CAT-6 cable.

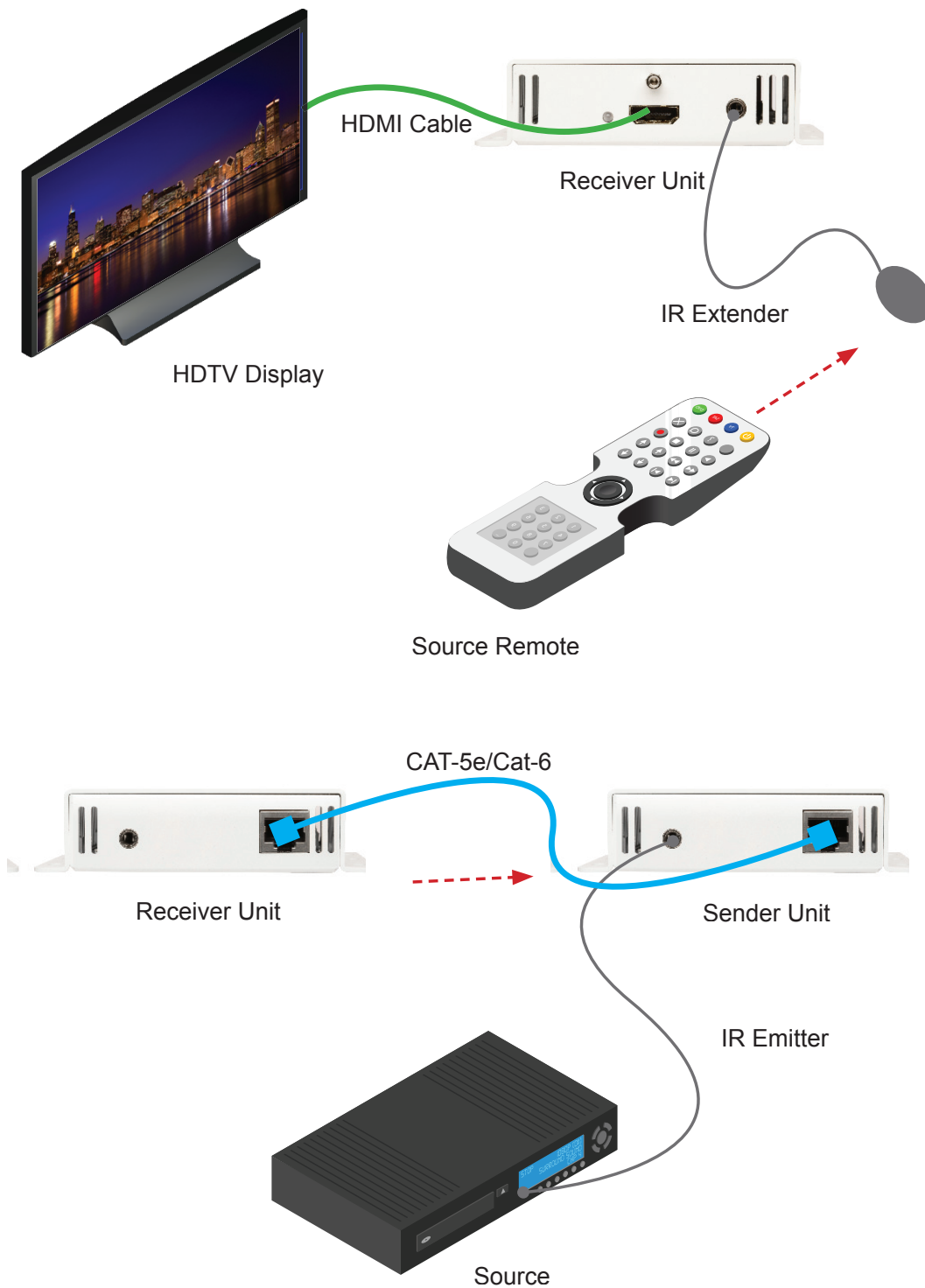

CONNECTING AND OPERATING THE EXTENDER FOR HDMI W/POL

How to Connect the Bi-Directional IR

Bi-Directional IR

Controlling the Display

In the example below, we will be setting up IR control for the display from the source location. The following illustrations assume all A/V devices have already been connected. **See page 8 for details.**

1. For IR control of a display from the source location, connect a 3.5mm-to-3.5mm mono or stereo cable from one of the **IR Emitter jacks** on an automation device, such as the Gefen PACS or Mini PACS, to the **IR In jack** on the Sender unit.

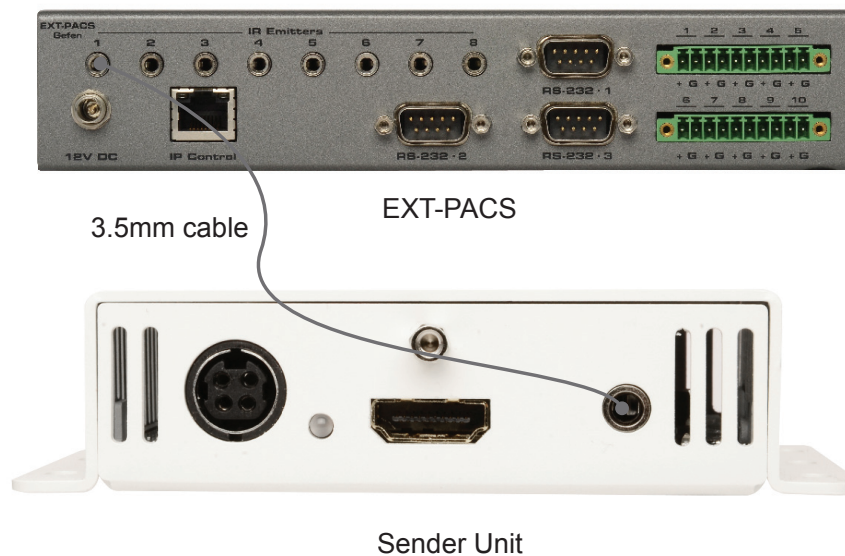

2. Connect an IR emitter from the **IR Out jack** on the Receiver unit to the IR sensor window of the HDTV display to be controlled.



CONNECTING AND OPERATING THE EXTENDER FOR HDMI W/POL

3. To control the display from the source location, point the included IR remote control at the PACS or Mini PACS connected to the Sender unit. The IR signals are transmitted from the Sender to the Receiver unit over the CAT-5e/CAT-6a cable.

Refer to the PACS or Mini PACS User Manual for more information on using IR commands.

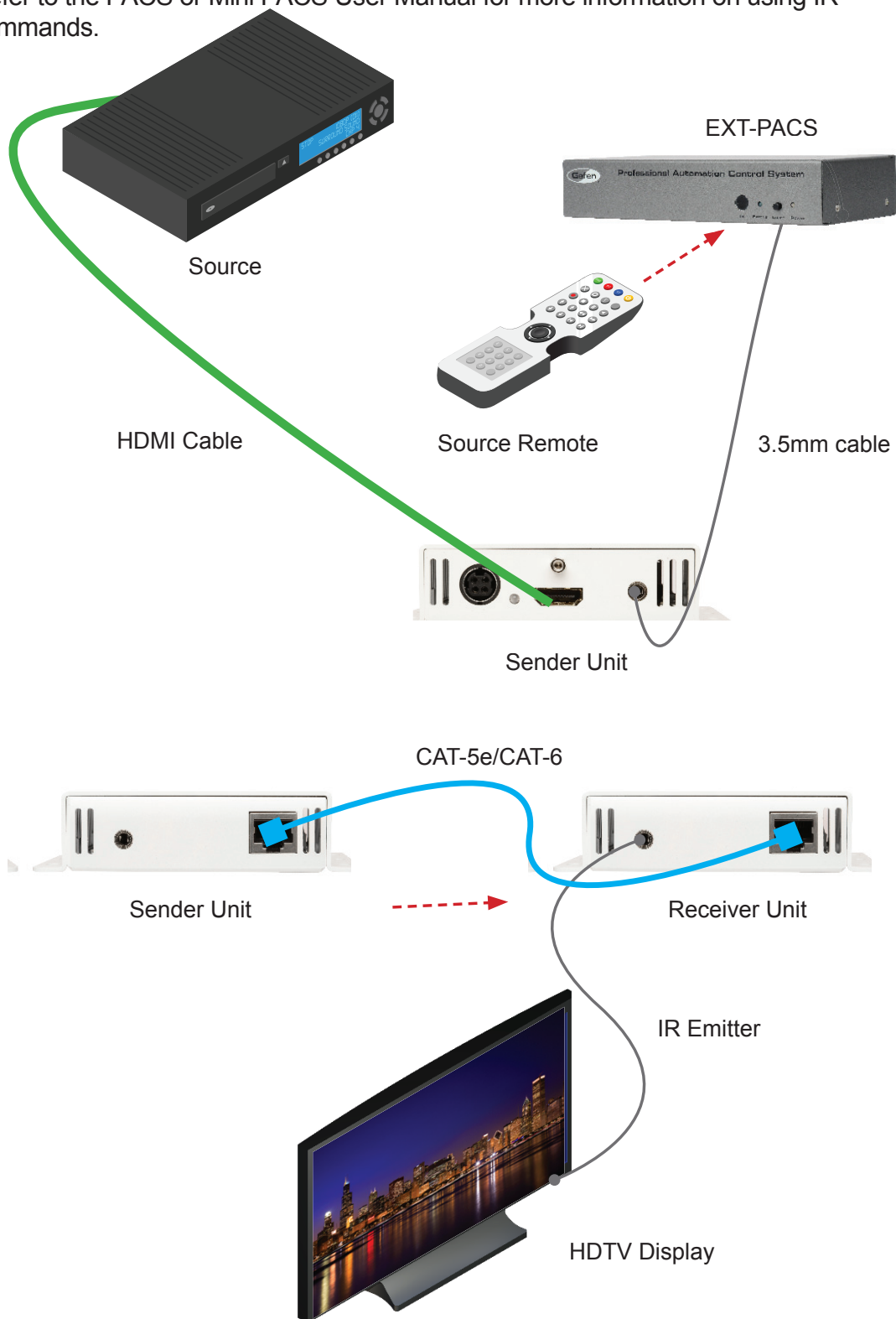

NETWORK CABLE WIRING DIAGRAM

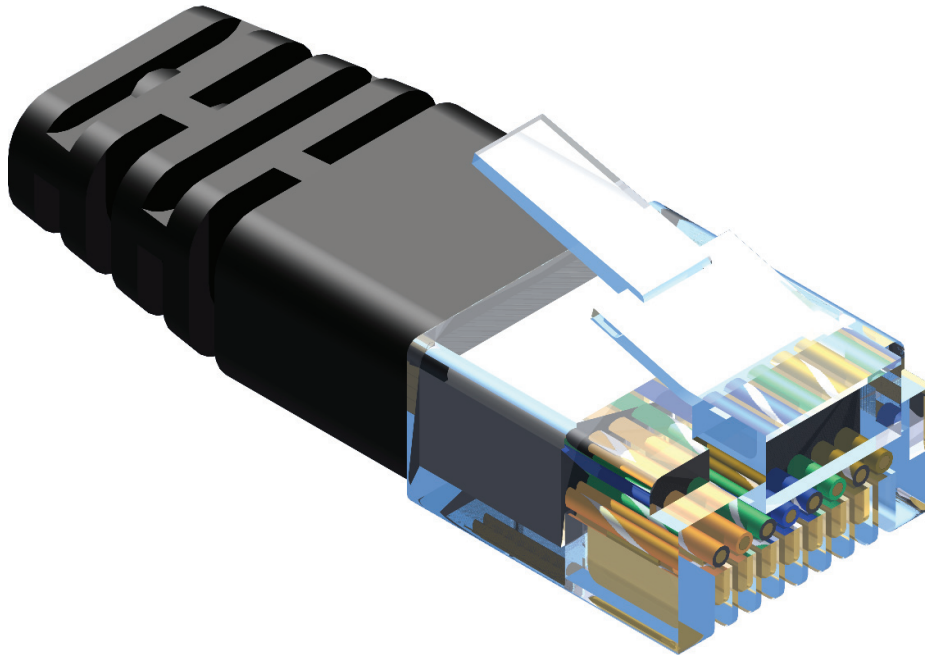

Gefen recommends the TIA/EIA-568-B wiring option. Please adhere to the table below when field terminating cable for use with Gefen products.

| Pin | Color |
|-----|----------------|
| 1 | Orange / White |
| 2 | Orange |
| 3 | Green / White |
| 4 | Blue |
| 5 | Blue / White |
| 6 | Green |
| 7 | Brown / White |
| 8 | Brown |

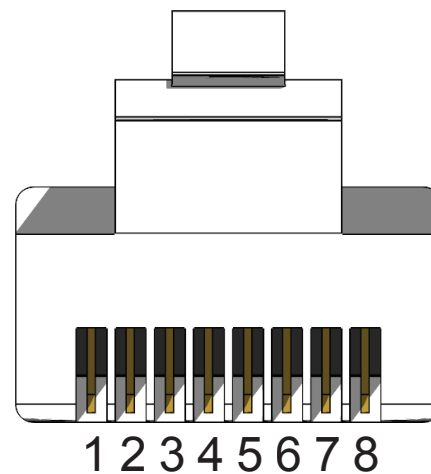

CAT-5, CAT-5e, and CAT-6 cabling comes in stranded and solid core types. Gefen recommends using solid core cabling. CAT-6a cable is also recommended.

It is recommended to use one continuous run from one end to the other. In some cases, connecting through a patch might not work.

WALL MOUNTING INSTRUCTIONS

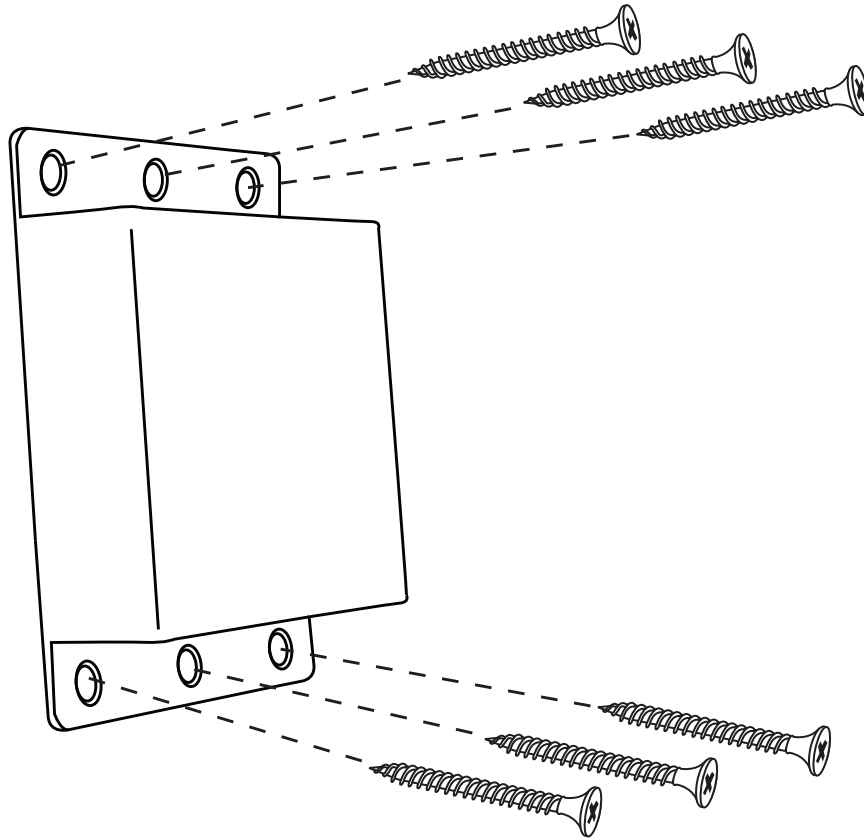

The GefenToolbox *Extender for HDMI w/POL* should be mounted vertically on a wall or inside / outside a cabinet with wood / drywall screws as shown in the diagram above. There should be an inch or two of clearance between the edges of the unit and any walls or vertical surfaces to allow for enough clearance for connection and disconnection of the HDMI cable.

For installation on a drywall surface, use a #6 drywall screw. When installing, it is recommended to use the center hole on a stud.

SPECIFICATIONS

| | |
|--|--|
| Maximum Pixel Clock..... | 225 MHz |
| Video Input Connector (Sender)..... | (1) HDMI Type-A, 19-pin, female, locking |
| Video Output Connector (Receiver)..... | (1) HDMI Type-A, 19-pin, female, locking |
| Link Connectors (Sender / Receiver)..... | (1) RJ-45, shielded |
| Power/HDCP Indicator LED: | Bi-color: Blue/Amber |
| IR Extender Port (Receiver):..... | 3.5mm mini-stereo jack |
| IR Out Port (Sender / Receiver):..... | 3.5mm mini-mono jack |
| IR In port (Sender):..... | 3.5mm mini-mono jack |
| Power Supply:..... | (1) 24V DC, locking |
| Power Consumption..... | 24W per unit (max.) |
| Operating Temperature | +32 to +104 °F (0 to +40 °C) |
| Dimensions (W x H x D)..... | 4.3" x 1." x 3.2" (86mm x 33mm x 83mm) |
| Shipping Weight..... | 4 lbs. (1.8 kg) |

WARRANTY

Gefen warrants the equipment it manufactures to be free from defects in material and workmanship.

If equipment fails because of such defects and Gefen is notified within two (2) years from the date of shipment, Gefen will, at its option, repair or replace the equipment, provided that the equipment has not been subjected to mechanical, electrical, or other abuse or modifications. Equipment that fails under conditions other than those covered will be repaired at the current price of parts and labor in effect at the time of repair. Such repairs are warranted for ninety (90) days from the day of reshipment to the Buyer.

This warranty is in lieu of all other warranties expressed or implied, including without limitation, any implied warranty or merchantability or fitness for any particular purpose, all of which are expressly disclaimed.

1. Proof of sale may be required in order to claim warranty.
2. Customers outside the US are responsible for shipping charges to and from Gefen.
3. Copper cables are limited to a 30 day warranty and cables must be in their original condition.

The information in this manual has been carefully checked and is believed to be accurate. However, Gefen assumes no responsibility for any inaccuracies that may be contained in this manual. In no event will Gefen be liable for direct, indirect, special, incidental, or consequential damages resulting from any defect or omission in this manual, even if advised of the possibility of such damages. The technical information contained herein regarding the features and specifications is subject to change without notice.

For the latest warranty coverage information, refer to the Warranty and Return Policy under the Support section of the Gefen Web site at www.gefen.com.

PRODUCT REGISTRATION

Please register your product online by visiting the Register Product page under the Support section of the Gefen Web site.

* MA - GTB - HDBT - POL *

Rev A2



20600 Nordhoff St., Chatsworth CA 91311
1-800-545-6900 818-772-9100 fax: 818-772-9120
www.gefentv.com support@gefentv.com



This product uses UL or CE listed power supplies.