



KRAMER ELECTRONICS LTD.

USER MANUAL

MODEL:

MV-6
3G HD-SDI Multiviewer

P/N: 2900-000737 Rev 1.1



MV-6 Quick Start Guide

This guide helps you install and use your product for the first time. For more detailed information, go to <http://www.kramerav.com/manual/MV-6> to download the latest manual or scan the QR code on the left.

Step 1: Check what's in the box

- MV-6** 3G HD-SDI Multiviewer
- 4 Rubber feet
- 1 Power cord
- 1 Quick Start sheet

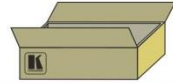

Save the original box and packaging materials in case you need to return your **MV-6** for service.

Step 2: Install the MV-6

Mount the **MV-6** in a rack (using the included rack "ears") or attach the rubber feet and place on a table.

Step 3: Connect the inputs and outputs

Always switch off the power on each device before connecting it to your **MV-6**.

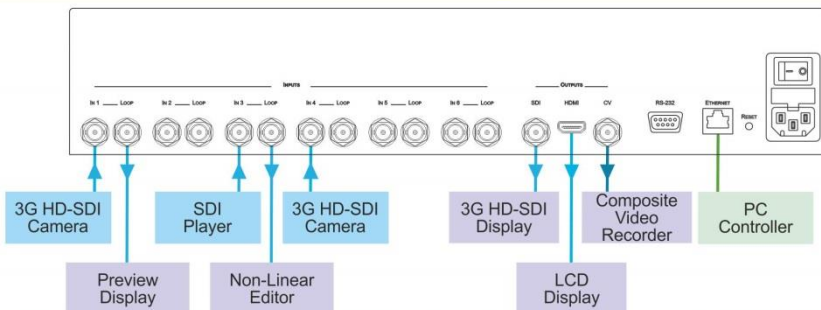

Always use Kramer high-performance cables for connecting AV equipment to the **MV-6**.

Step 4: Connect the power

Connect the power cord to the **MV-6** and plug it into the mains electricity.



Step 5: Operate the MV-6

Configure and operate the device locally using the front panel buttons or remotely using the RS-232/Ethernet connection.

Contents

1	Introduction	1
2	Getting Started	2
2.1	Achieving the Best Performance	2
2.2	Safety Instructions	3
2.3	Recycling Kramer Products	3
3	Overview	4
3.1	Accessory to Medical Equipment (IEC 60601-1)	5
3.2	Defining the MV-6 3G HD-SDI Multiviewer	5
4	Installing in a Rack	9
5	Connecting the MV-6	10
5.1	Connecting to the RS-232 Port	11
5.2	Connecting via Ethernet	12
6	Operating the MV-6 Locally	16
6.1	Using the Display	16
6.2	Adjusting the Size of a Window	16
6.3	Adjusting the Position of a Window	17
6.4	Defining and Saving a Custom Window Layout	17
6.5	Recalling a Window Layout	18
6.6	Freezing/Releasing a Video Output	18
6.7	Locking the Front Panel	18
6.8	Resetting the Device to Factory Defaults	19
6.9	Using the Menu	19
7	Operating the MV-6 Remotely	23
7.1	Operating the MV-6 via the RS-232 Serial Port	23
7.2	MV-6 Controller Software	23
7.3	The Menu Bar	25
7.4	Upgrading the Firmware	36
8	Technical Specifications	37
9	Default Communication Parameters	38
10	Kramer Protocol 3000 Syntax	39
10.1	Host Message Format	39
10.2	Device Message Format	39
10.3	Command Terms	40
10.4	Entering Commands	41
10.5	Bidirectional Definition	41
10.6	Command Chaining	41
10.7	Maximum String Length	42
11	Protocol 3000 Commands	43
11.1	System Commands - Mandatory	43
11.2	System Commands	48
11.3	Video Commands	52
11.4	Multiviewer Commands	55
11.5	Communication Commands	62
12	Parameters	66
12.1	On/Off	66
12.2	Color Space	66
12.3	Genlock Types	66
12.4	Stage	66

12.5	Video Resolutions	66
12.6	Custom Resolution Parameters	68
12.7	View Modes	68
12.8	Font Size	69

Figures

Figure 1: MV-6 3G HD-SDI Multiviewer Front Panel	6
Figure 2: MV-6 3G HD-SDI Multiviewer Rear Panel	8
Figure 3: Connecting the MV-6 3G HD-SDI Multiviewer	11
Figure 4: Local Area Connection Properties Window	13
Figure 5: Internet Protocol Version 4 Properties Window	13
Figure 6: Internet Protocol Version 6 Properties Window	14
Figure 7: Internet Protocol Properties Window	14
Figure 8: MV-6 Controller Software Main Window	24
Figure 9: Quick Access Toolbar	26
Figure 10: Connect Window	27
Figure 11: Windows Position	28
Figure 12: Switch Buttons	29
Figure 13: Layer Order	30
Figure 14: Switching an Input to a Window	31
Figure 15: Windows Setup Window	32
Figure 16: Input Button Properties Window	33
Figure 17: Device Details Window	34
Figure 18: About MV-6 Window	36

1 Introduction

Welcome to Kramer Electronics! Since 1981, Kramer Electronics has been providing a world of unique, creative, and affordable solutions to the vast range of problems that confront video, audio, presentation, and broadcasting professionals on a daily basis. In recent years, we have redesigned and upgraded most of our line, making the best even better!

Our 1,000-plus different models now appear in 14 groups that are clearly defined by function: GROUP 1: Distribution Amplifiers; GROUP 2: Switchers and Routers; GROUP 3: Control Systems; GROUP 4: Format/Standards Converters; GROUP 5: Range Extenders and Repeaters; GROUP 6: Specialty AV Products; GROUP 7: Scan Converters and Scalers; GROUP 8: Cables and Connectors; GROUP 9: Room Connectivity; GROUP 10: Accessories and Rack Adapters; GROUP 11: Sierra Video Products; GROUP 12: Digital Signage; GROUP 13: Audio; and GROUP 14: Collaboration.

Congratulations on purchasing your Kramer **MV-6 3G HD-SDI Multiviewer**, which is ideal for the following typical applications:

- Professional broadcasting and production studios
- Presentation applications
- 3G HD-SDI multi-viewing for medical equipment

2 Getting Started

We recommend that you:

- Unpack the equipment carefully and save the original box and packaging materials for possible future shipment
- Review the contents of this user manual



Go to www.kramerav.com/downloads/MV-6 to check for up-to-date user manuals, application programs, and to check if firmware upgrades are available (where appropriate).

2.1 Achieving the Best Performance

To achieve the best performance:

- Use only good quality connection cables (we recommend Kramer high-performance, high-resolution cables) to avoid interference, deterioration in signal quality due to poor matching, and elevated noise levels (often associated with low quality cables)
- Do not secure the cables in tight bundles or roll the slack into tight coils
- Avoid interference from neighboring electrical appliances that may adversely influence signal quality
- Position your Kramer **MV-6** away from moisture, excessive sunlight and dust



This equipment is to be used only inside a building. It may only be connected to other equipment that is installed inside a building.

2.2 Safety Instructions



Caution: There are no operator serviceable parts inside the unit

Warning: Use only the power cord that is supplied with the unit

Warning: Do not open the unit. High voltages can cause electrical shock! Servicing by qualified personnel only

Warning: Disconnect the power and unplug the unit from the wall before installing

2.3 Recycling Kramer Products

The Waste Electrical and Electronic Equipment (WEEE) Directive 2002/96/EC aims to reduce the amount of WEEE sent for disposal to landfill or incineration by requiring it to be collected and recycled. To comply with the WEEE Directive, Kramer Electronics has made arrangements with the European Advanced Recycling Network (EARN) and will cover any costs of treatment, recycling and recovery of waste Kramer Electronics branded equipment on arrival at the EARN facility. For details of Kramer's recycling arrangements in your particular country go to our recycling pages at <http://www.kramerelectronics.com/support/recycling/>.

3 Overview

The **MV-6** is a versatile, high-performance video viewer for signals up to 3G HD-SDI. The device can window up to six sources in any layout and output the image in SDI, HDMI and CV formats. Both preprogrammed and customizable screen division is supported.

In particular, the **MV-6** features:

- Input bandwidth of up to 3Gbps which supports standard definition, high definition and 3G high definition serial digital video signals (SD/HD/3G HD-SDI)

Standard Definition (SD) means an NTSC or PAL compatible video format consisting of 480 (for NTSC) or 576 (for PAL) lines of interlaced video.

High Definition (HD) means a video format consisting of 720 active lines of progressive video or 1080 lines of progressive or interlaced video.

- SMPTE 259M, 292M and 424M input compliance and support for data rates of 270Mbps, 1483.5Mbps, 1485Mbps, 2967Mbps and 2970Mbps
- Input cable equalization up to 350m (1150ft) for SD signals, 140m for 1.5GHz HD signals, and 120m (394ft) for 3GHz HD signals
- Multi-video output formats; HD-SDI (292M) and 3G HD-SDI (SMPTE 424M), HDMI and composite
- Front panel color LCD preview screen for real-time display of output
- Kramer re-Klocking™ and equalization on each input – rebuilds the digital signal to travel longer distances
- Flexible control options; front panel with menu LCD and on-screen displays, Ethernet, and RS-232
- Screen handling buttons; freeze, size, position, and four pre-programmed and two user-definable layouts
- Medical equipment compliance

The **MV-6** is housed in a 2U height enclosure and is fed from a 100-240 VAC universal switching power supply. The device can be controlled via the front panel buttons and remotely via:

- RS-232 serial commands transmitted by a PC, touch-screen system or other serial controller
- Ethernet over a LAN

3.1 Accessory to Medical Equipment (IEC 60601-1)

In the modern medical environment remote access is essential, for example, to transfer clinical data between doctors and to train to medical students. The **MV-6** is certified according to the IEC 60601-1-2, Clause 2.1.3, Medical Electrical Equipment, Part 1: General Requirements for EMC standard which is required when accessory devices are used at locations where medical personnel and patients are present.

The **MV-6** constitutes an optional component that can be considered necessary and suitable as part of medical equipment or for use as part of a medical system to provide real time simultaneous video feeds to those present at the local medical environment and at remote locations. In this environment, the **MV-6** can be added to the system **ONLY** if the connecting equipment has been evaluated and meets the IEC 60601-1-2 EMC standards. Note, that when attaching accessory devices to a digital or analog interface, they must comply with the IEC standard for which they are used: EMC Standard (IEC 60601-1-2), Information Technology equipment (IEC 60950-1 (2ed)).

3.2 Defining the MV-6 3G HD-SDI Multiviewer

This section defines the **MV-6**.

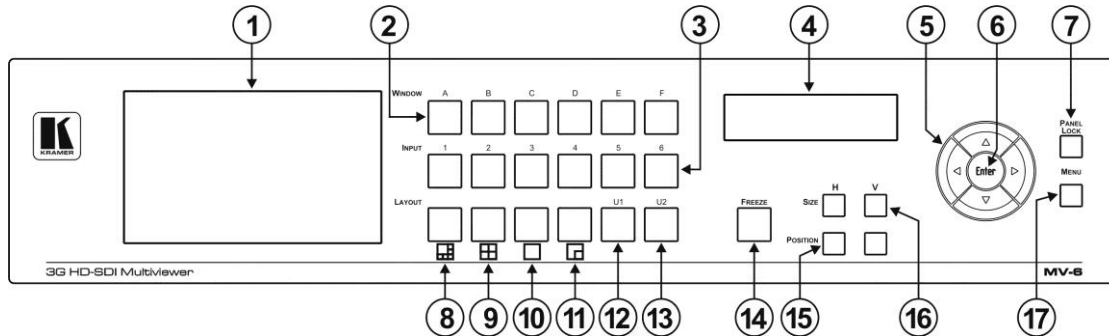





Figure 1: MV-6 3G HD-SDI Multiviewer Front Panel

#	Feature	Function
1	LCD Video Preview Screen	LCD screen to display the output signal
2	WINDOW Buttons (A to F)	Press to select one of the windows
3	INPUT Buttons (1 to 6)	Press to select the active input following selection of an active window (using the WINDOW buttons)
4	LCD Menu 2 Line x 16 Character Window/Input or Menu Display	During normal operation the Window/Input list is displayed. During menu operations, the Menu/parameter/values are displayed (see Section 6.9)
5	Menu Navigation Buttons	Press the up (▲), down (▼), left (◀) and right (▶) buttons to navigate the menu, parameters or values
6	ENTER Button	Press to enter the menu or accept the parameter/value
7	PANEL LOCK Button	Press and hold to lock the front panel buttons. Press and hold again to unlock the buttons (see Section 6.7)
8	Screen Layout Button (6 windows)	 Press to display and output all six inputs as per the pattern
9	Screen Layout Button (4 windows)	 Press to display and output four selected inputs in a quad pattern
10	Screen Layout Button (full screen)	 Press to display and output one selected input as a full screen
11	Screen Layout Button (2 windows)	 Press to display and output two selected inputs as per the pattern

12	U1 Button	Press to select the first user-definable output window pattern (programmed using the menu, see Section 7.3)
13	U2 Button	Press to select the second user-definable output window pattern (programmed using the menu, see Section 7.3)
14	FREEZE Button	Press to freeze the selected video window (see Section 6.6)
15	POSITION Buttons	Press either the horizontal (H) or vertical (V) button to change the position of the active window (see Section 6.3)
	SIZE Buttons	Press either the width (H) or height (V) button to change the size of the active window (see Section 6.9)
17	MENU Button	Press to move back one level through the menu (see Section 6.9)

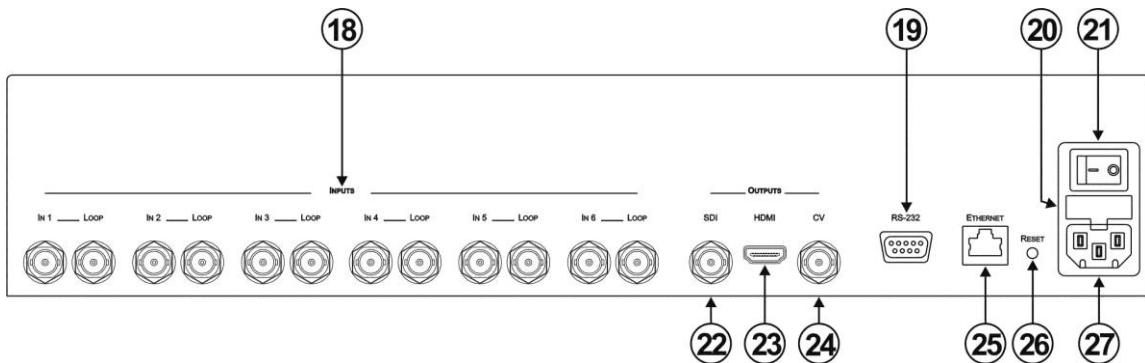

Figure 2: MV-6 3G HD-SDI Multiviewer Rear Panel

#	Feature	Function
18	INPUTS (1 to 6) and Associated BNC LOOP Outputs (1 to 6)	Connect Inputs to video sources and Loop outputs to loop video acceptors (see Section 5)
19	RS-232 9-pin D-sub (F) Connector	Connect to the serial port on a PC or remote controller (see Section 5.1)
20	Mains Power Fuse	Fuse for protecting the device
21	Mains Power Switch	Switch for turning the device on or off
22	OUTPUTS SDI BNC Connector	Connect to an SDI video acceptor (see Section 6.9)
23	OUTPUTS HDMI Connector	Connect to an HDMI video acceptor
24	OUTPUTS CV BNC Connector	Connect to a composite video acceptor
25	ETHERNET RJ-45 Connector	Connect to a PC via a LAN for remote control (see Section 5.2)
26	RESET Button	Press and hold while power cycling the device to reset to factory default configuration (see Section 6.8)
27	Mains Power Connector	Connect to the mains power

4 Installing in a Rack

This section provides instructions for rack mounting the unit.

Before installing in a rack, be sure that the environment is within the recommended range:

OPERATING TEMPERATURE:	0° to +40°C (32° to 104°F)
STORAGE TEMPERATURE:	-40° to +70°C (-40° to 158°F)
HUMIDITY:	10% to 90%, RHL non-condensing



CAUTION!

When installing on a 19" rack, avoid hazards by taking care that:

1. It is located within the recommended environmental conditions, as the operating ambient temperature of a closed or multi unit rack assembly may exceed the room ambient temperature.
2. Once rack mounted, enough air will still flow around the machine.
3. The machine is placed straight in the correct horizontal position.
4. You do not overload the circuit(s). When connecting the machine to the supply circuit, overloading the circuits might have a detrimental effect on overcurrent protection and supply wiring. Refer to the appropriate nameplate ratings for information. For example, for fuse replacement, see the value printed on the product label.
5. The machine is earthed (grounded) in a reliable way and is connected only to an electricity socket with grounding. Pay particular attention to situations where electricity is supplied indirectly (when the power cord is not plugged directly into the socket in the wall), for example, when using an extension cable or a power strip, and that you use only the power cord that is supplied with the machine.

To rack-mount a machine:

1. Attach both ear brackets to the machine. To do so, remove the screws from each side of the machine (5 on each side), and replace those screws through the ear brackets.

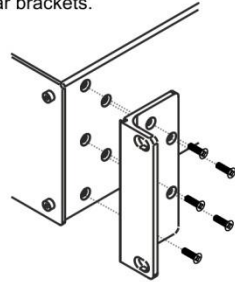

2. Place the ears of the machine against the rack rails, and insert the proper screws (not provided) through each of the four holes in the rack ears.

Note:

- In some models, the front panel may feature built-in rack ears
- Detachable rack ears can be removed for desktop use
- Always mount the machine in the rack before you attach any cables or connect the machine to the power
- If you are using a Kramer rack adapter kit (for a machine that is not 19"), see the Rack Adapters user manual for installation instructions available from our Web site

5 Connecting the MV-6



Always switch off the power to each device before connecting it to your **MV-6**. After connecting your **MV-6**, connect its power and then switch on the power to each device.

The **MV-6** accepts up to six SD/HD/3G HD-SDI inputs. The device outputs a signal (which can be any combination of the inputs) to the SDI, HDMI and composite video connectors as shown in [Figure 3](#).

To connect the **MV-6 3G HD-SDI Multiviewer** as shown in [Figure 3](#):

1. Connect up to six SDI sources (SD, HD or 3G HD-SDI) to the INPUT BNC connectors (for example, 3G HD-SDI cameras to IN 1 and IN 3, and an SDI player to IN 2).
2. Connect up to six SDI acceptors (SD, HD or 3G HD-SDI) to the INPUT LOOP BNC connectors (for example, a preview SDI display to IN 1—LOOP and a non-linear editor to IN 2—LOOP).
3. Connect up to three display acceptors to the OUTPUT connectors (for example, a 3G HD-SDI display to the OUTPUT SDI BNC connector, an LCD display to the HDMI connector, and a CV video recorder to the OUTPUT CV BNC connector).
4. Optional—Connect a PC and/or serial controller to the:
 - Ethernet connector (see [Section 5.2](#))
—and/or—
 - RS-232 port (see [Section 5.1](#))
5. Connect the power cord (not shown in the illustration).

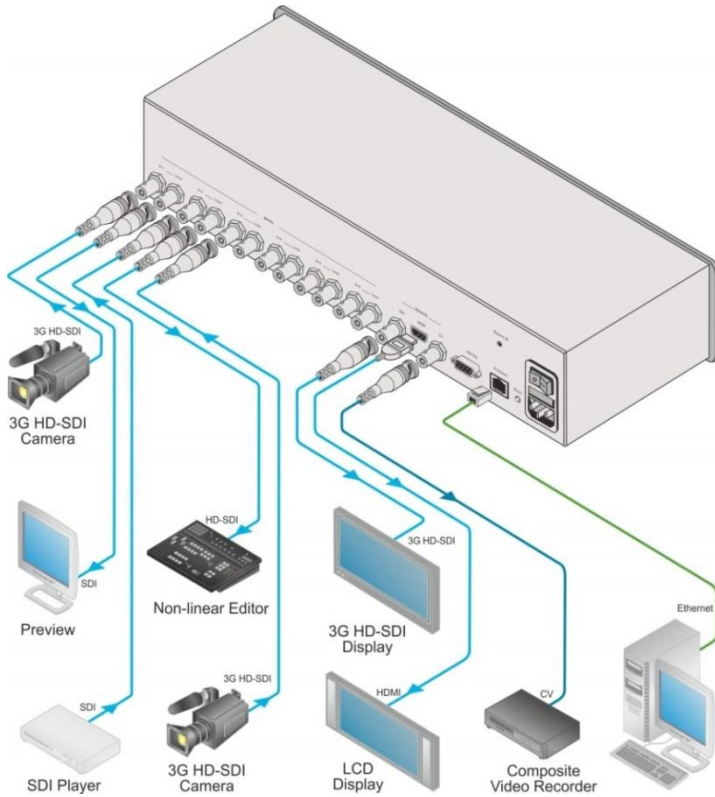

Figure 3: Connecting the MV-6 3G HD-SDI Multiviewer

5.1 Connecting to the RS-232 Port

You can connect to the **MV-6** via an RS-232 connection using, for example, a PC. Note that a null-modem adapter/connection is not required.

To connect to the MV-6 via RS-232:

- Connect the RS-232 9-pin D-sub rear panel port on the **MV-6** via a 9-wire straight cable (only pin 2 to pin 2, pin 3 to pin 3, and pin 5 to pin 5 need to be connected) to the RS-232 9-pin D-sub port on your PC

5.2 Connecting via Ethernet

You can connect to the **MV-6** via Ethernet using either of the following methods:

- Directly to the PC using a crossover cable (see [Section 5.2.1](#))
- Via a network hub, switch, or router, using a straight-through cable (see [Section 5.2.2](#))

Note: If you want to connect via a router and your IT system is based on IPv6, speak to your IT department for specific installation instructions.

5.2.1 Connecting the Ethernet Port Directly to a PC

You can connect the Ethernet port of the **MV-6** directly to the Ethernet port on your PC using a crossover cable with RJ-45 connectors.



This type of connection is recommended for identifying the **MV-6** with the factory configured default IP address.

After connecting the **MV-6** to the Ethernet port, configure your PC as follows:

1. Click **Start > Control Panel > Network and Sharing Center**.
2. Click **Change Adapter Settings**.
3. Highlight the network adapter you want to use to connect to the device and click **Change settings of this connection**.

The Local Area Connection Properties window for the selected network adapter appears as shown in [Figure 4](#).

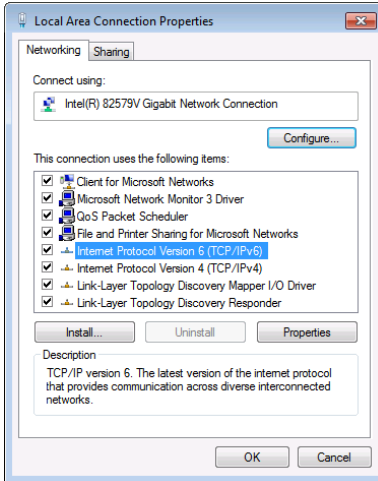

Figure 4: Local Area Connection Properties Window

4. Highlight either **Internet Protocol Version 6 (TCP/IPv6)** or **Internet Protocol Version 4 (TCP/IPv4)** depending on the requirements of your IT system.
5. Click **Properties**.
The Internet Protocol Properties window relevant to your IT system appears.

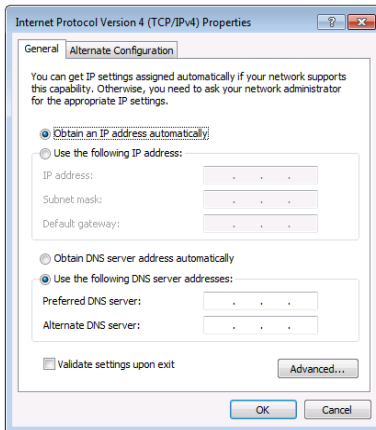

Figure 5: Internet Protocol Version 4 Properties Window

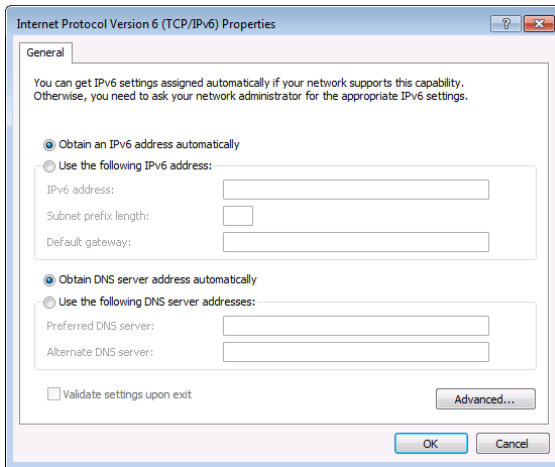

Figure 6: Internet Protocol Version 6 Properties Window

6. Select **Use the following IP Address** for static IP addressing and fill in the details as shown in [Figure 7](#).

For TCP/IPV4 you can use any IP address in the range 192.168.1.1 to 192.168.1.255 (excluding 192.168.1.39) that is provided by your IT department.

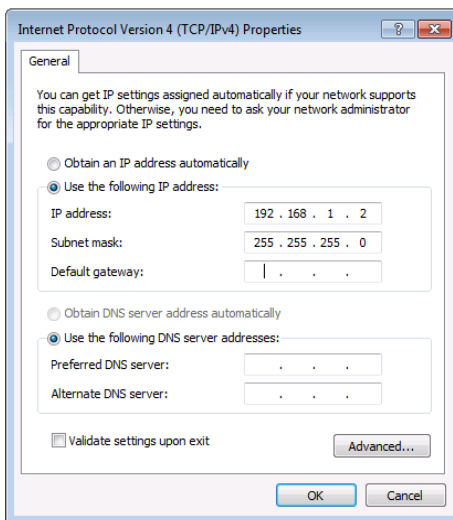

Figure 7: Internet Protocol Properties Window

7. Click **OK**.
8. Click **Close**.

5.2.2 Connecting the Ethernet Port via a Network Hub or Switch

You can connect the Ethernet port of the **MV-6** to the Ethernet port on a network hub or using a straight-through cable with RJ-45 connectors.

6 Operating the MV-6 Locally

The **MV-6** sports an LCD video preview screen on which the live video output is shown. Changes made to the device configuration are reflected immediately on the screen allowing you to monitor the output in real-time.

The **MV-6** is operated locally using the front panel buttons.

6.1 Using the Display

When the **MV-6** is powered on, the following is displayed briefly:

```
MV6 Multiviewer
```

```
KRAMER
```

The device then performs a self-test. If the test is successful the Window/Input list is displayed, an example of which is shown below.

```
WIN A B C D E F
```

```
INP 2 4 5 6 1 3
```

During operation, if there is no button activity for approximately 60 seconds the display reverts to the Window/Input list.

6.2 Adjusting the Size of a Window

The horizontal and vertical size of each window can be modified.

To adjust the size of a window:

1. Select the required window by pressing one of the Window buttons.
The relevant button lights.
2. Press either the H Size or V Size button to adjust the width or height of the selected window.

3. Use the left (◀) and right (▶) buttons to adjust the window width, and use the up (▲) and down button (▼) to adjust the window height. The size changes in real-time.
4. Press Menu twice to exit the window size setting.

6.3 Adjusting the Position of a Window

The horizontal and vertical position of each window can be modified.

To adjust the position of a window:

1. Select the required window by pressing one of the Window buttons. The relevant button lights.
2. Press either the H Position or V Position button to move the window.
3. Use the left (◀) and right (▶) buttons to move the window horizontally, and use the up (▲) and down button (▼) to move the window vertically. The position changes in real-time.
4. Press Menu twice to exit the window position setting.

6.4 Defining and Saving a Custom Window Layout

In addition to the four predefined window layouts, the **MV-6** can store two custom window layouts. Once you have defined a custom window layout you can save it for future recall.

To define and save a custom, user-defined window layout:

1. Using the Size and Position buttons, adjust all windows to the required configuration.
2. Press and hold either the U1 or U2 Layout button until the button flashes once. The window layout is stored in the respective memory.

6.5 Recalling a Window Layout

You can select any of the four predefined or two custom window layouts using the window layout buttons.

To select a window layout:

- Press one of the six screen layout buttons.
The button flashes quickly three times and the window layout is recalled from the memory

6.6 Freezing/Releasing a Video Output

To freeze/release a video output:

1. Select the required window to freeze.
2. Press the Freeze button (see [FREEZE Button](#)).
The button lights and the output video freezes.
3. Press the Freeze button.
The button no longer lights and the video is no longer frozen.

6.7 Locking the Front Panel

Lock the front panel buttons to prevent unwanted key presses from changing the current configuration.

To lock the front panel:

- Press and hold the Panel Lock button (see [PANEL LOCK Button](#)). The button lights and the front panel buttons are locked. Pressing any button causes the Locked message to display and the Lock button to flash

To unlock the front panel:

- Press and hold the Panel Lock button (see [PANEL LOCK Button](#)). The button no longer lights and the front panel buttons are unlocked

6.8 Resetting the Device to Factory Defaults

To reset the device to the factory defaults:

1. Turn the device off.
2. Press and hold the Reset button on the rear panel of the device.
3. While holding the button depressed, turn the device on.
4. Hold the button depressed for 10 seconds and release the button.
The configuration is reset to the factory default.

6.9 Using the Menu

The menu is displayed on the character display when the Enter button is pressed. After no button activity for about a minute, the window input list is displayed but the menu remains open in the background at the same position it was last left in.

Navigation through the menu is performed as follows:

- Enter—display the menu or select a parameter/value
- Up (▲)—scroll up through the parameter/value list
- Down (▼)—scroll down through the parameter/value list
- Left (◀)—move left in the current field
- Right (▶)—move right through the current field
- Menu—Move up one level in the menu hierarchy

The main menu comprises six sections:

- Windows (see [Section 6.9.1](#))
- Output (see [Section 6.9.2](#))
- Status (see [Section 6.9.3](#))
- Comm Settings (see [Section 6.9.4](#))
- User Presets (see [Section 6.9.5](#))
- System (see [Section 6.9.6](#))

6.9.1 Windows Sub-Menu

The parameters in the Windows Sub-Menu set the window inputs and characteristics.

Parameter		Description	Values
Select window		Selects the window to adjust	A, B, C, D, E, F Default—F
Visibility		Makes the selected window visible or non-visible	Visible, Non-Visible Default—Visible
Select layer		Selects a source to display in the selected window	TOP, 2, 3, 4, 5, 6 Default—TOP
Input		Selects an input	1, 2, 3, 4, 5, 6 Default—1
Size	Hor size(%)	Sets the horizontal size for the selected window	1 to 100 Default— 66
	Ver size(%)	Sets the vertical size for the selected window	1 to 100 Default— 66
Position	X origin(%)	Sets the X origin for the selected window	0 to 99 Default— 0
	Y origin(%)	Sets the Y origin for the selected window	0 to 99 Default— 0
Freeze		Freezes or releases the video	ON, OFF Default—OFF

6.9.2 Output Sub-Menu

The parameters in the Output Sub-Menu set the output and LCD preview screen characteristics.

Note: NTSC or PAL is automatically selected depending on the selected output resolution refresh rate.

Parameter	Description	Values
RESOLUTION	Sets the output resolution	720p59.94, 720p60, 720p50, 1080p59.94, 1080p60, 1080p50 Default— 720p59.94
GENLOCK MODE	Turns on and off and sets the source of the unlock signal	NO GENLOCK, INPUT 1, INPUT 2, INPUT 3, INPUT 4, INPUT 5, INPUT 6 Default—NO GENLOCK
BACKGROUND >	Sets the background color using R, G and B values	000 to 255 Default—R=1, G=101, B=53
WIN BORDER	Turns the window border on or off	ON, OFF Default—ON
WIN TEXT	Turns the window text labels on and off	ON, OFF Default—ON

6.9.3 Status Sub-Menu

The parameters in the Status Sub-Menu display the input states.

Parameter	Description	Values
INPUTS >	Displays the input states	IN 1 unlocked, IN 2 unlocked, IN 3 unlocked, IN 4 unlocked, IN 5 unlocked, IN 6 unlocked
GENLOCK unlocked	Displays the Genlock state	

6.9.4 Comm Settings Sub-Menu

The parameters in the Comm Settings Sub-Menu set the network IP and serial communications values.

Parameter	Description	Options
NETWORK	IP address	Sets the IP network address All valid IP addresses Default—192.168.001.039
	IP mask	Sets the IP network mask All valid subnets Default—255.255.000.000
	IP gateway	Sets the IP gateway address All valid gateway addresses Default—000.000.000.000
	IP port	Sets the IP port number All valid TCP ports Default—05000
RS-232	Baud	Displays the baud rate 115200
	Parity	Displays the parity setting none

6.9.5 User Presets Sub-Menu

The options in the User Presets Sub-Menu save and recall the preset configuration memories (see [Section 6.4](#)).

Parameter	Description	Options
SAVE	Saves the current screen layout as a user defined layout	USER PRESET 1, USER PRESET 2 Default—USER PRESET 1
LOAD	Loads the selected user defined screen layout	USER PRESET 1, USER PRESET 2 Default—USER PRESET 1

6.9.6 System Sub-Menu

The parameters in the System Sub-Menu display the device versions and set the video screen characteristics.

Parameter	Description	Options
FIRMWARE	The device firmware version	
FPGA VER	The device FPGA version	
S/N	The device serial number	
LCD	Back Light	AUTO, ON Default—AUTO
	Brightness	0 to 100 Default—100

7 Operating the MV-6 Remotely

The **MV-6** can be operated remotely using the Kramer **MV-6** Controller software via the:

- RS-232 serial port (see [Section 7.1](#))
- Ethernet port (see [Section 7.2](#))

7.1 Operating the MV-6 via the RS-232 Serial Port

Kramer offers free control software that allows you to operate the **MV-6** remotely via a PC or serial controller using serial commands (see [Section 11](#)). This software can be downloaded from http://www.kramerelectronics.com/support/product_downloads.asp.

7.2 MV-6 Controller Software

For details regarding connecting to the Ethernet port on the **MV-6**, see [Section 5.2](#).

The Controller software requires the following:

- Windows™ XP, Vista or Windows™ 7
- Microsoft .Net Framework version 3.5

To install the Controller software, download the software and run the setup file. After installation, running the Controller software for the first time displays a window similar to that shown in [Figure 8](#).

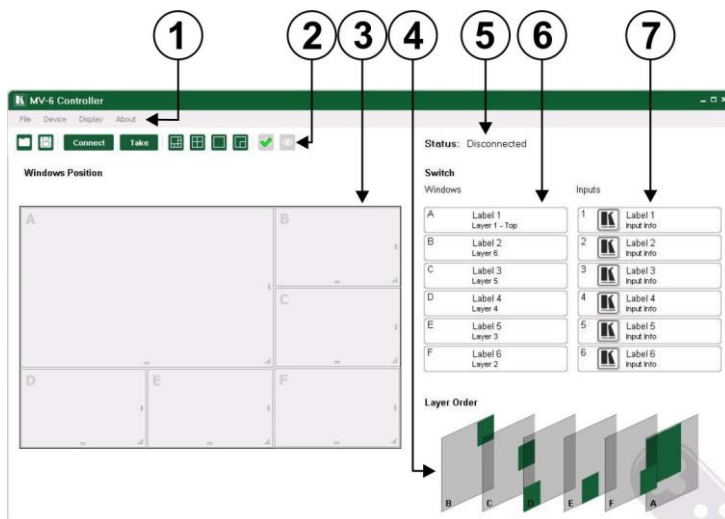

Figure 8: MV-6 Controller Software Main Window

#	Feature	Function
1	Menu Bar	Operate and configure the device using the Menu Bar options (see Section 7.3)
2	Quick Access Toolbar	Operate and configure the device using the quick access toolbar buttons (see Section 7.3.1)
3	<i>Windows Position</i>	Modify window size and position by dragging and dropping individual windows (see Section 7.3.3)
4	<i>Layer Order</i>	Click and drag individual layers to arrange the layer order (see Section 7.3.6)
5	<i>Status Indicator</i>	Indicates whether or not the Controller software is connected to the device (see Section 7.3.5)
6	<i>Switch Windows</i>	Press to select a window (see Section 7.3.9)
7	<i>Switch Inputs</i>	Press to select an inputs (see Section 7.3.8)

Note: Unless the device is in off-line mode (by pressing the **Take** button), when a change is made on the device (for example, a different output is selected), the change is reflected almost immediately in the main window of the Controller Software. Similarly, if a change is made in the Controller Software, the change is reflected almost immediately on the device.

7.3 The Menu Bar

The menu bar options are shown in the following table.

Menu Bar Options	Sub Menu	Description
FILE	<i>Open</i>	Open an existing configuration
	<i>Save</i>	Save the current configuration
	<i>Exit</i>	Exit the MV-6 Controller software
DEVICE	<i>Connect/Disconnect</i>	Connect or disconnect to the device (see Section 7.3.2)
	<i>Take/Update</i>	Press Take to put the device in off-line mode. Press Update to implement waiting changes and return the device to on-line mode (see Section 7.3.7)
	<i>Firmware Update</i>	Update the device firmware (see Section 7.3.12)
	<i>Device Details</i>	Retrieve and display the device details, such as, model, unit name, version, and so on. (see Section 7.3.11)
DISPLAY	<i>Presets</i>	Set the screen to display one of the preconfigured configurations: 6-Split, Quad, Full, 2-Split
	<i>Output Resolution</i>	Set the output resolution: 720P 59.94Hz, 720P 50Hz, 1080P 60Hz, 720P 60Hz, 1080P 59.94Hz, 1080P 50Hz
	<i>Genlock Control</i>	Unlocks the genlock or sets the source for genlock control: Free Run (default), Input 1, Input 2, Input 3, Input 4, Input 5, Input 6
	<i>Background Color</i>	Sets the background color of the window
	<i>Window Border</i>	Turns the window border on and off
	<i>Refresh</i>	Retrieves full information from the device
ABOUT	Displays the Step-in Software and Kramer company details	













Note: Any actions that you are not authorized to perform are grayed out.

7.3.1 The Quick Access Toolbar

The Quick Access Toolbar buttons are shown in [Figure 9](#).



Figure 9: Quick Access Toolbar

Feature	Description
	Open an existing project
	Save the current project
 	Connects to and disconnects from the device (see Section 7.3.2)
 	Press Take to enable multiple off-line changes to be made. Press Update to implement the changes (see Section 7.3.7)
	Set the screen to display the 6-window configuration
	Set the screen to display the 4-window configuration
	Set the screen to display the single-window configuration
	Set the screen to display the 2-window configuration
	Freezes the output video
	Sets the visibility of the active window

7.3.2 Connecting to the Device

To connect to the device:

1. Click the **Connect** button.

The window shown in [Figure 10](#) appears.

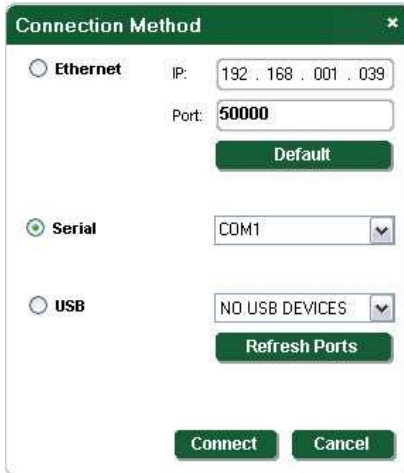

Figure 10: Connect Window

2. Select the required method of connection radio button:
 - For Ethernet, enter the IP address and Port number of the device. To set the default IP address and Port number, press the **Default** button.
 - For a serial connection, select the required Com port from the drop-down list.
3. Click **Connect**.

If the connection is successful, the main window shown in [Figure 8](#) appears. If the connection is not successful, a Timeout error message appears.

7.3.3 Windows Position

The windows can be manually manipulated in size and position in the **Window Position** area.

Windows Position

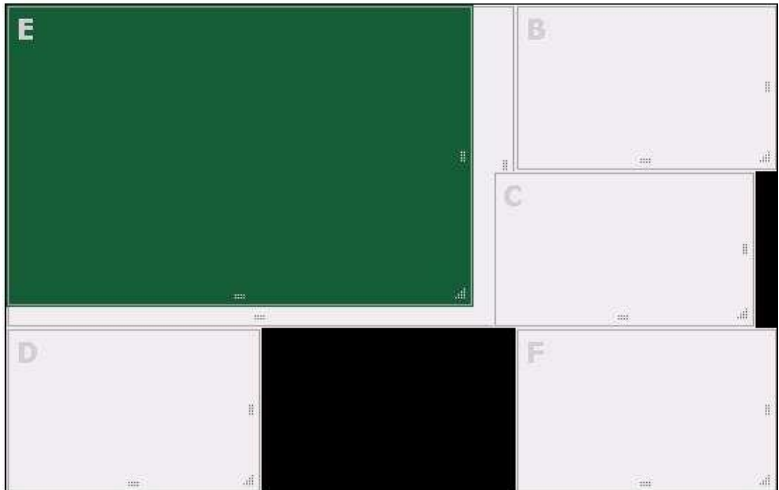

Figure 11: Windows Position

To change the size of a window:

- Click, hold and drag the required window handle

To change the position of a window:

- Click, hold and drag anywhere in the window

7.3.4 Switch Buttons

The switching configuration can be modified by clicking on the **Windows** and **Inputs** buttons.

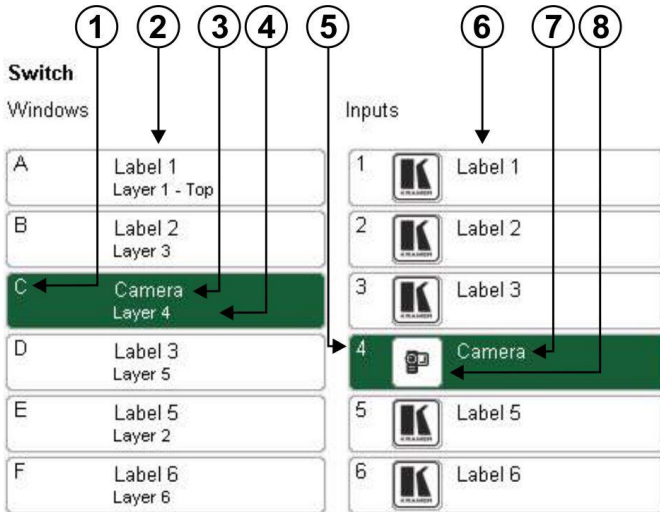

Figure 12: Switch Buttons

#		Description
1	C Window	Window identifier (A to F)
2	Windows Buttons (A to F)	Press to select a window to assign to an input (see Section 7.3.8)
3	Camera	The label of the input assigned to this window (see Section 7.3.8)
4	Layer 4	The layer (Top layer to 6) of this window (see Section 7.3.6)
5	4	Input number (1 to 6)
6	Inputs Buttons (1 to 6)	Press to select an input to assign to a window (see Section 7.3.8)
7	Camera	Input button label (see Section 7.3.8)
8	Input icon	User assigned icon for this input (see Section 7.3.8)

7.3.5 Connection Status

The connection status can be one of the following states:

- Online—the device is connected and being updated in real-time by the software
- Online, in take mode (not updating device)—the device is connected but changes are only implemented when the Update button is pressed
- Offline—in Take mode

7.3.6 Changing the Layer Order

You can modify the order in which the windows are arranged. The top layer is on the right and the bottom layer on the left. In [Figure 13](#) layer A is on top and layer F is at the bottom.

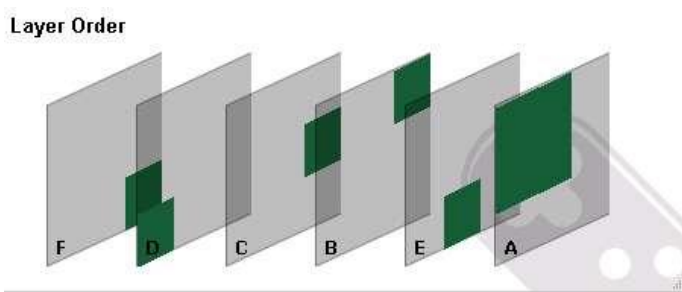

Figure 13: Layer Order

To change the window layer order:

1. Click and hold on the layer that you want to move.
2. Drag the layer to the right or left into the required position and release. The layer is placed in the required position.

7.3.7 Implementing Multiple Actions At Once

To implement multiple actions at once:

1. Press the **Take** button to put the device in off-line mode.
The button changes to the **Update** button and the device is in off-line mode.
2. Perform the required actions, such as, switching and layer order changes.
3. Press the **Update** button.
The button changes to the **Take** button and all changes are implemented.

7.3.8 Switching an Input to a Window

To switch an input to a window:

1. Click on the required window button.
The window is selected and the button changes to a solid color as shown in [Figure 14](#).



Figure 14: Switching an Input to a Window

2. Click on the required Inputs button.
The input is assigned to the previously selected window and the button changes to a solid color.

7.3.9 Changing a Window Setup

To change a window setup:

1. Right-click on the relevant Windows button.

The **Window Setup** window appears as shown in [Figure 15](#).

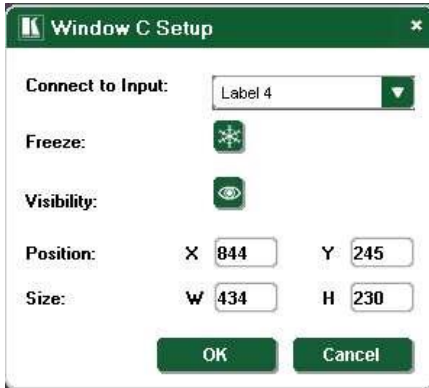

Figure 15: Windows Setup Window

2. From the **Connect to Input** drop-down list, select the required input.
3. Click the **Freeze** icon to freeze this window.
4. Click the **Visibility** icon to modify the visibility of this window.
5. In the **Position** fields, enter the x and y position for the window.
6. In the **Size** fields, enter the width and height for the window.
7. Click **OK**.

The Window setup is changed.

7.3.10 Changing Input Button Properties

To change the properties of an input button:

1. Right-click on the relevant input button.

The **Input Properties** window appears as shown in [Figure 16](#).

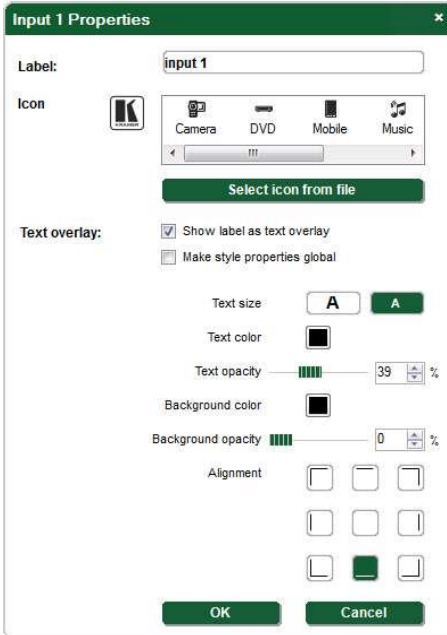

Figure 16: Input Button Properties Window

2. In the **Label** text box, enter the required button label.
(The label is limited to 10 characters.)
3. Select the required icon from the list or click on the **Select icon from file** button and browse to the required file.
4. Modify the **Text Overlay** properties as required.
5. Click **OK**.
The input button characteristics are changed.

7.3.11 Changing the Device Details

From this window you can change the device name and its IP communication parameters.

To change the device details:

1. From the Menu bar, click on **Device**.

The **Device Details** window appears as shown in [Figure 17](#).

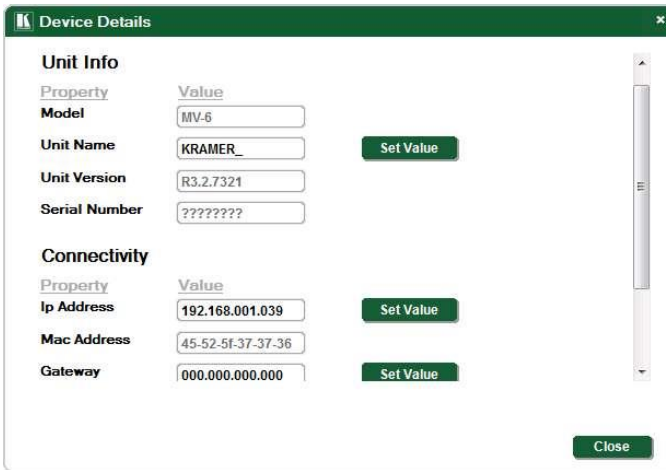

The screenshot shows a window titled "Device Details" with a green header bar. It is divided into two main sections: "Unit Info" and "Connectivity".

Unit Info

Property	Value	
Model	MV-6	
Unit Name	KRAMER_	Set Value
Unit Version	R3.2.7321	
Serial Number	????????	

Connectivity

Property	Value	
Ip Address	192.168.001.039	Set Value
Mac Address	45-52-5f-37-37-36	
Gateway	000.000.000.000	Set Value

A "Close" button is located at the bottom right of the window.

Figure 17: Device Details Window

2. Modify the parameters as required. For each modified parameter, click **Set Value**.
3. Click **Close**.

Note: If you modify any of the IP parameters you need to reconnect to the device with the new parameters.

7.3.12 Updating the Firmware

To update the firmware you must be logged in as Admin.

To update the firmware:

1. Download the latest firmware file from
http://www.kramerelectronics.com/support/product_downloads.asp.
2. Click **Unit > Firmware Update**.
3. Browse to the firmware file that you downloaded.
4. Click **Open**.
The device firmware is loaded.

Note: Do not interrupt the uploading process or the device may be damaged.

5. When the process is complete, reset the device.

7.3.13 Setting the IP Network Parameters

To set the IP network parameters you must be logged in as Admin.

To set the IP network parameters:

1. Click **Unit > Device Details**.
2. Under **Connectivity**, edit the required parameter.
3. Click **Set Value**.
A confirmation message appears.
4. Click **OK**.
The parameter is set.
5. Reboot the device.

7.3.14 Displaying the MV-6 Software Version Number

To display the MV-6 Software version number:

1. From the Menu bar, click **About**.

The **About MV6 Controller** window appears as shown in [Figure 18](#).



Figure 18: About MV-6 Window

2. Click **OK** to close the window.

7.4 Upgrading the Firmware

For instructions on upgrading the firmware see “*Upgrading the MV-6 Firmware Using the K-Upload Software*”.

Note: To upgrade to firmware V3.2.7321 you must use K-Upload software V1.0.0.50. After upgrading, perform a factory reset (see [Section 6.8](#)).

8 Technical Specifications

INPUTS:	6 SDI serial video, 75Ω on BNC connectors	SD	SMPTE-259M	SMPTE-125M	480i – 59.94
				ITU-R BT.656-5	576i – 50
		HD	SMPTE-292	SMPTE-296M	720p – 59.94/60/50
				SMPTE-274M	1080i – 59.94/60/50 1080p – 29.97/30/25 23.98/24 23.98sF/24sF
	3G	SMPTE-424M	SMPTE-296M	1080p – 59.94/60/50	
MAX. INPUT LEVEL:	800mVpp /75Ω				
OUTPUTS:	1 HDMI (The device does not pass audio)				
	1 CV on a BNC connector				
	For 720p @50Hz and 1920p @50Hz the output is PAL				
	For 720p @59.94/60Hz and 1920p @59.94/60Hz the output is NTSC				
	1 SDI output, 75Ω on BNC connector	SMPTE-292	SMPTE-296M	720p – 59.94/60/50	
SMPTE-424M		SMPTE-296M	1080p – 59.94/60/50		
MAX. OUTPUT LEVEL:	800mVpp /75Ω				
6 LOOP					
PREVIEW SCREEN:	4.3" TFT color LCD panel				
SERIAL BIT DATA RATE:	Up to 2.97Gbps				
CONTROLS:	Front-panel, RS-232, Ethernet				
POWER CONSUMPTION:	Universal, 100-240V AC, 50/60Hz 35VA				
OPERATING TEMPERATURE:	0° to +40°C (32° to 104°F)				
STORAGE TEMPERATURE:	-40° to +70°C (-40° to 158°F)				
HUMIDITY:	10% to 90%, RHL non-condensing				
DIMENSIONS:	19" x 7.4" x 2U (W, D, H) rack mountable				
WEIGHT:	3.1kg (6.83lbs) approx.				
INCLUDED ACCESSORIES:	Power cord, Rack "ears"				
Specifications are subject to change without notice at http://www.kramerelectronics.com					

9 Default Communication Parameters

RS-232	
Protocol 3000	
Baud Rate:	115200
Data Bits:	8
Stop Bits:	1
Parity:	None
Command Format:	ASCII
Example (Output 1 to Input 2):	#V 2>1 <code>CR</code>
Ethernet	
To reset the IP settings to the factory reset values, power cycle the device while holding in the Factory Reset button, located on the rear panel of the unit	
IP Address:	192.168.1.39
Subnet mask:	255.255.255.0
Default gateway:	192.168.1.1
TCP Port #: 5000	5000
UDP Port #: 50000	50000
Maximum UDP Ports:	10
Maximum TCP Ports:	4

10 Kramer Protocol 3000 Syntax

The **MV-6** can be operated using serial commands from a PC, remote controller or touch screen using the Kramer Protocol 3000.

With Kramer Protocol 3000 you can control a device from any standard terminal software (for example, the Windows® HyperTerminal Application).

This RS-232/RS-485 communications protocol uses a data rate of 115,200 baud, no parity, 8 data bits, and 1 stop bit.

10.1 Host Message Format

Start	Address (opt)	Body	Delimiter
#	Destination_id@	Message	CR

10.1.1 Simple Command

Command string with only one command without addressing:

Start	Body	Delimiter
#	Command SP Parameter_1,Parameter_2,...	CR

10.1.2 Command String

Formal syntax with commands concatenation and addressing:

Start	Address	Body	Delimiter
#	Destination_id@	Command_1 Parameter1_1,Parameter1_2,... Command_2 Parameter2_1,Parameter2_2,... Command_3 Parameter3_1,Parameter3_2,...	CR

10.2 Device Message Format

Start	Address (opt)	Body	Delimiter
~	Sender_id@	Message	CR LF

10.2.1 Device Long Response

Echoing command:

Start	Address (opt)	Body	Delimiter
~	Sender_id@	Command SP [Param1,Param2 ...] result	CR LF

CR = Carriage return (ASCII 13 = 0x0D)

LF = Line feed (ASCII 10 = 0x0A)

SP = Space (ASCII 32 = 0x20)

10.3 Command Terms

Command

A sequence of ASCII letters ('A'-'Z', 'a'-'z' and '-').

Command and parameters must be separated by at least one space.

Parameters

A sequence of alphanumeric ASCII characters ('0'-'9', 'A'-'Z', 'a'-'z' and some special characters for specific commands). Parameters are separated by commas.

Message string

Every command entered as part of a message string begins with a **message starting character** and ends with a **message closing character**.

Note: A string can contain more than one command. Multiple commands are separated by a pipe (|) character.

Message starting character

'#' - For host command/query

'-' - For machine response or machine command performed by keystroke operation on the front panel or IR remote controller.

Device address (Optional when directly connected to the device)

K-Net Device ID or MACHINE NUMBER followed by '@'

(ex. #02@**CR LF**)

Query sign

'?' follows some commands to define a query request.

All outputs sign

'*' defines all outputs.

Message closing character

CR - For host messages; carriage return (ASCII 13)

CR LF - For machine messages; carriage return (ASCII 13) + line-feed (ASCII 10)

Command chain separator character

When a message string contains more than one command, a pipe (|) character separates each command.

Spaces between parameters or command terms are ignored.

10.4 Entering Commands

You can directly enter all commands using a terminal with ASCII communication software, such as HyperTerminal, Hercules, etc. Connect the terminal to the serial, Ethernet, or USB port on the Kramer device. To enter CR, press the Enter key. (LF is also sent but is ignored by the command parser).

For commands sent from some non-Kramer controllers such as Crestron, some characters require special coding (such as, /X##). Refer to the controller manual.

10.5 Bidirectional Definition

All commands are bidirectional. That is, if the device receives the code, it performs the instruction. If the instruction is performed (due to a keystroke operation on the front panel or IR controller) these codes are sent to the PC or other RS-232 / Ethernet / USB controller.

10.6 Command Chaining

Multiple commands can be chained in the same string. Each command is delimited by a pipe character (|). When chaining commands, enter the **message starting character** and the **message closing character** once only, at the beginning of the string and at the end.

Commands in the string do not execute until the closing character is entered. A separate response is sent for every command in the chain.

10.7 Maximum String Length

64 characters.

11 Protocol 3000 Commands

11.1 System Commands - Mandatory

All devices running Protocol 3000 use these commands.

Command	Description	Type	Permission
#	Protocol handshaking	System-mandatory	End User
BUILD-DATE?	Get device build date	System-mandatory	End User
FACTORY	Reset to factory default configuration	System-mandatory	End User
HELP	Get command list	System-mandatory	End User
MODEL?	Get device model	System-mandatory	End User
PROT-VER?	Get device protocol version	System-mandatory	End User
RESET	Reset device	System-mandatory	Administrator
SN?	Get device serial number	System-mandatory	End User
VERSION?	Get device firmware version	System-mandatory	End User

Command - #		Command Type - System-mandatory	
Command Name		Permission	Transparency
Set:	#	End User	Public
Get:	-	-	-
Description		Syntax	
Set:	Protocol handshaking	# <input type="checkbox"/>	
Get:	-	-	
Response			
~nn@ <input type="checkbox"/> SP <input type="checkbox"/> OK <input type="checkbox"/> CR LF			
Parameters			
Response Triggers			
Notes			
Use to validate the Protocol 3000 connection and get the machine number			

Command - BUILD-DATE		Command Type - System-mandatory	
Command Name		Permission	Transparency
Set:	-	-	-
Get:	BUILD-DATE?	End User	Public
Description		Syntax	
Set:	Get device build date	# BUILD-DATE _{CR}	
Get:	-	-	
Response			
- _{nn} @ BUILD-DATE _{SP} date _{SR} time _{CR LF}			
Parameters			
date - Format: YYYY/MM/DD where YYYY = Year, MM = Month, DD = Day			
time - Format: hh:mm:ss where hh = hours, mm = minutes, ss = seconds			
Response Triggers			
Notes			

Command - FACTORY		Command Type - System-mandatory	
Command Name		Permission	Transparency
Set:	FACTORY	End User	Public
Get:	-	-	-
Description		Syntax	
Set:	Reset device to factory default configuration	# FACTORY _{CR}	
Get:	-	-	
Response			
- _{nn} @ FACTORY _{SP} OK _{CR LF}			
Parameters			
Response Triggers			
Notes			
This command deletes all user data from the device. The deletion can take some time.			

Command - HELP		Command Type - System-mandatory	
Command Name		Permission	Transparency
Set:	-	-	-
Get:	HELP	End User	Public
Description		Syntax	
Set:	-	-	
Get:	Get command list or help for specific command	2 options: 1. #HELP _{CR} 2. #HELP _{SP} <i>command_name</i> _{CR}	
Response			
1. Multi-line: ~ hn @ Device available protocol 3000 commands: _{CR LF} <i>command</i> _{SP} <i>command</i> ... _{CR LF} To get help for command use: HELP (COMMAND_NAME) _{CR LF}			
2. Multi-line: ~ hn @ HELP _{SP} <i>command</i> : _{CR LF} <i>description</i> _{CR LF} USAGE : <i>usage</i> _{CR LF}			
Parameters			
Response Triggers			
Notes			

Command - MODEL?		Command Type - System-mandatory	
Command Name		Permission	Transparency
Set:	-	-	-
Get:	MODEL?	End User	Public
Description		Syntax	
Set:	-	-	
Get:	Get device model	#MODEL? _{CR}	
Response			
~ hn @ MODEL _{SP} <i>model_name</i> _{CR LF}			
Parameters			
model_name - String of up to 19 printable ASCII chars			
Response Triggers			
Notes			

Command - PROT-VER?		Command Type - System-mandatory	
Command Name		Permission	Transparency
Set:	-	-	-
Get:	PROT-VER?	End User	Public
Description		Syntax	
Set:	-	-	
Get:	Get device protocol version	# PROT-VER? <input type="checkbox"/> CR	
Response			
~ <input type="checkbox"/> <input type="checkbox"/> @ PROT-VER <input type="checkbox"/> SP3000:version <input type="checkbox"/> CR LF			
Parameters			
Version - XX.XX where X is a decimal digit			
Response Triggers			
Notes			

Command - RESET		Command Type - System-mandatory	
Command Name		Permission	Transparency
Set:	RESET	Administrator	Public
Get:	-	-	-
Description		Syntax	
Set:	Reset device	# RESET <input type="checkbox"/> CR	
Get:	-	-	
Response			
~ <input type="checkbox"/> <input type="checkbox"/> @ RESET <input type="checkbox"/> SPOK <input type="checkbox"/> CR LF			
Parameters			
Response Triggers			
Notes			
To avoid locking the port due to a USB bug in Windows, disconnect USB connections immediately after running this command. If the port was locked, disconnect and reconnect the cable to reopen the port.			

Command - SN?		Command Type - System-mandatory	
Command Name		Permission	Transparency
Set:	-	-	-
Get:	SN?	End User	Public
Description		Syntax	
Set:	-	-	
Get:	Get device serial number	# SN? <input type="checkbox"/> <input type="checkbox"/>	
Response			
~ <input type="checkbox"/> <input type="checkbox"/> @ SN? <input type="checkbox"/> <i>serial_number</i> <input type="checkbox"/> <input type="checkbox"/> <input type="checkbox"/>			
Parameters			
<i>serial_number</i> - 11 decimal digits, factory assigned			
Response Triggers			
Notes			
For new products with 14 digit serial numbers, use only the last 11 digits			

Command - VERSION?		Command Type - System-mandatory	
Command Name		Permission	Transparency
Set:	-	-	-
Get:	VERSION?	End User	Public
Description		Syntax	
Set:	-	-	
Get:	Get firmware version number	# VERSION? <input type="checkbox"/> <input type="checkbox"/>	
Response			
~ <input type="checkbox"/> <input type="checkbox"/> @ VERSION? <input type="checkbox"/> <i>firmware_version</i> <input type="checkbox"/> <input type="checkbox"/> <input type="checkbox"/>			
Parameters			
<i>firmware_version</i> - XX.XX.XXXX where the digit groups are: major.minor.build version			
Response Triggers			
Notes			

11.2 System Commands

Command	Description	Type	Permission
FPGA-VER?	Get current FPGA version	System	End User
LOCK-FP	Set/get front panel lock	System	Administrator
MACH-NUM	Set machine number	System	Administrator
NAME	Set/get machine (DNS) name	System	Administrator
NAME-RST	Reset machine name to factory default (DNS)	System	Administrator
PRST-RCL	Recall saved preset list	System	End User
UPGRADE	Perform firmware upgrade	System	Administrator

Command - FPGA-VER?		Command Type - System	
Command Name		Permission	Transparency
Set:	-	-	-
Get:	FPGA-VER?	End User	Public
Description		Syntax	
Set:	-	-	
Get:	Get current FPGA version	# FPGA-VER? _{SP} id _{CR}	
Response			
-nn@ FPGA-VER _{SP} id, expected_ver, actual_ver _{CR LF}			
Parameters			
id - FPGA id expected_ver - expected FPGA version for current firmware actual_ver - actual FPGA version			
Response Triggers			
Notes			

Command - LOCK-FP		Command Type - System	
Command Name		Permission	Transparency
Set:	LOCK-FP	End User	Public
Get:	LOCK-FP?	End User	Public
Description		Syntax	
Set:	Lock front panel	Option 1: # LOCK-FP _[SP] / <i>lock_mode</i> _[CR] Option 2: # LOCK-FP _[SP] / <i>device_id,lock_mode</i> _[CR]	
Get:	Get front panel lock state	Option 1: # LOCK-FP? _[CR] Option 2: # LOCK-FP? _[SP] / <i>device_id</i> _[CR]	
Response			
Set: Option 1: ~ <i>nn</i> @ LOCK-FP _[SP] / <i>lock_mode</i> _[SP] OK _[CR LF] Option 2: ~01@ LOCK-FP _[SP] / <i>device_id,lock_mode</i> _[SP] OK _[CR LF]			
Get: Option 1: ~ <i>nn</i> @ LOCK-FP _[SP] / <i>lock_mode</i> _[CR LF] Option 2: ~01@ LOCK-FP _[SP] / <i>device_id,lock_mode</i> _[CR LF]			
Parameters			
<i>lock_mode</i> - 0/OFF - unlocks the front panel buttons, 1/ON - locks the front panel buttons <i>device_id</i> - for K-Net controllers, select the button panel to lock. Locking is allowed only from the master			
Response Triggers			
Notes			

Command - MACH-NUM		Command Type - System	
Command Name		Permission	Transparency
Set:	MACH-NUM	End User	Public
Get:	-	-	-
Description		Syntax	
Set:	Set machine number	# MACH-NUM _[SP] / <i>machine_number</i> _[CR]	
Get:	-	-	
Response			
~ <i>nn</i> @ MACH-NUM _[SP] / <i>machine_number</i> OK _[CR LF]			
Parameters			
<i>machine_number</i> - new device machine number			
Response Triggers			
Notes			
Some devices do not set the new machine number until the device is restarted Some devices can change the machine number only from DIP-switches			

Command - NAME		Command Type - System (Ethernet)	
Command Name		Permission	Transparency
Set:	NAME	Administrator	Public
Get:	NAME?	End User	Public
Description		Syntax	
Set:	Set machine (DNS) name	#NAME _[SP] machine_name _[CR]	
Get:	Get machine (DNS) name	#NAME? _[CR]	
Response			
Set:	~nn@NAME _[SP] machine_name _[SP] OK _[CR LF]		
Get:	~nn@NAME? _[SP] machine_name _[CR LF]		
Parameters			
<i>machine_name</i> - String of up to 14 alpha-numeric chars (can include hyphen, not at the beginning or end)			
Response Triggers			
Notes			
The machine name is not the same as the model name. The machine name is used to identify a specific machine or a network in use (with DNS feature on)			

Command - NAME-RST		Command Type - System (Ethernet)	
Command Name		Permission	Transparency
Set:	NAME-RST	Administrator	Public
Get:	-	-	-
Description		Syntax	
Set:	Reset machine (DNS) name to factory default	#NAME-RST _[CR]	
Get:	-	-	
Response			
~nn@NAME-RST _[SP] OK _[CR LF]			
Parameters			
Response Triggers			
Notes			
Factory default of machine (DNS) name is "KRAMER_" + 4 last digits of device serial number			

Command - PRST-RCL		Command Type - System	
Command Name		Permission	Transparency
Set:	PRST-RCL	End User	Public
Get:	-	-	-
Description		Syntax	
Set:	Recall saved preset list	# PRST-RCL _{SP} <i>preset</i> _{CR}	
Get:	-	-	
Response			
~ nn @ PRST-RCL _{SP} <i>preset</i> _{CR LF}			
Parameters			
<i>preset</i> - preset number			
Response Triggers			
Notes			
In most units, video and audio presets with the same number are stored and recalled together by commands #PRST-STO and #PRST-RCL			

Command - UPGRADE		Command Type - System	
Command Name		Permission	Transparency
Set:	UPGRADE	Administrator	Internal
Get:	-	-	-
Description		Syntax	
Set:	Perform firmware upgrade	# UPGRADE _{CR}	
Get:	-	-	
Response			
~ nn @ UPGRADE _{SP} OK _{CR LF}			
Parameters			
Response Triggers			
Notes			
Not necessary for some devices Firmware usually uploads to a device via a command like LDFW Reset the device to complete the process			

11.3 Video Commands

Command	Description	Type	Permission
BCKGRND	Set/get screen background color	Video	End User
GNLCK	Set/get genlock state	Video	End User
VID-RES	Set/get output resolution	Video	End User

Command - BCKGRND		Command Type - Video	
Command Name		Permission	Transparency
Set:	BCKGRND	End User	Public
Get	BCKGRND?	End User	Public
Description		Syntax	
Set:	Set screen background color	# BCKGRND _{SP} ColSpaceType,p1,p2,p3 _{CR LF}	
Get:	Get screen background color	# BCKGRND? _{CR}	
Response			
~ _{CR} @ BCKGRND _{SP} ColSpaceType,p1,p2,p3 _{CR LF}			
Parameters			
ColSpaceType - define color space in use (see Section 12.2 Color Space) p1,p2,p3 - according to color space value: RGB - R,G,B YCbCr - Y,Cb,Cr			
Response Triggers			
After execution, response is sent to the com port from which the Set/Get was received After execution, response is sent to all com ports if BCKGRND was set by any other external control device (button press, device menu and similar)			
Notes			

Command - GNLCK		Command Type - Video	
Command Name		Permission	Transparency
Set:	GNLCK	Administrator	Public
Get:	GNLCK?	End User	Public
Description		Syntax	
Set:	Set genlock source and mode	#GNLCK _[SP] out,in,type _[CR]	
Get:	Get genlock source, mode and status	#GNLCK? _[SP] out _[CR]	
Response			
Set / Get: ~ _[nn] @GNLCK _[SP] out,in,status _[CR LF]			
Parameters			
<i>out</i> - output number (1 .. max number of outputs) <i>in</i> - input number (1... max number of inputs) <i>type</i> - genlock type (see Section 12.3 Genlock Types) <i>status</i> - genlock status (ON/OFF) (see Section 12.1 On/Off)			
Response Triggers			
Response is sent to the com port from which the Set (before execution) / Get command was received After execution, response is sent to all com ports if GNLCK was set for any other external control device (button press, device menu and similar) or genlock status changed			
Notes			

Command - VID-RES		Command Type - Video	
Command Name		Permission	Transparency
Set:	VID-RES	End User	Public
Get	VID-RES?	End User	Public
Description		Syntax	
Set:	Set output resolution	#VID-RES _{SP} stage, stage_id,is_native,resolution _{CR}	
Get:	Get output resolution	#VID-RES? _{SP} stage,stage_id,is_native _{CR}	
Response			
~nn@VID-RES _{SP} stage,stage_id,is_native,resolution _{CR LF}			
Parameters			
<i>stage</i> - input/output (see Section 12.4 Stage) <i>stage_id</i> - number of chosen stage (1... max number of inputs/outputs) <i>is_native</i> - native resolution flag (see Section 12.1 On/Off) <i>resolution</i> - resolution index (see Section 12.5 Video Resolutions)			
Response Triggers			
After execution, response is sent to the com port from which the Set/Get was received After execution, response is sent to all com ports if VID-RES was set by any other external control device (button press, device menu and similar)			
Notes			
"Set" command is only applicable for stage=Output "Set" command with <i>is_native</i> =ON sets native resolution on selected output (resolution index sent = 0). Device sends as answer actual VIC ID of native resolution "Get" command with <i>is_native</i> =ON returns native resolution VIC, with <i>is_native</i> =OFF returns current resolution To use "custom resolutions" (entries 100-105 in Section 12.6 Custom Resolution Parameters), define them using the DEF-RES command			

11.4 Multiviewer Commands

Command	Description	Type	Permission
CRDT	Set/get window size and position	Multiviewer	End User
OVRL	Set/get text overlay parameters	Multiviewer	End User
OVRLBK	Set/get text overlay background parameters	Multiviewer	End User
OVRLTXT	Set/get overlay text	Multiviewer	End User
SRC-BLANK	Set/get window visibility	Multiviewer	End User
SRC-VID	Set/get window input	Multiviewer	End User
WIN	Set/get active window	Multiviewer	End User
WND-BRD	Enable/ Disable window border	Multiviewer	End User
WND-FRZ	Set/get freeze on selected window	Multiviewer	End User
WND-LR	Set/get window overlay order	Multiviewer	End User
WND-ALL_LR	Set/get ALL window overlay order	Multiviewer	End User

Command - CRDT		Command Type - Multiviewer	
Command Name		Permission	Transparency
Set:	CRDT	End User	Public
Get:	CRDT?	End User	Public
Description		Syntax	
Set:	Set window size and position	# CRDT _{SP} win_num,x0,y0,x1,y1 _{CR}	
Get:	Get window size and position	# CRDT? _{SP} win_num _{CR}	
Response			
Set: ~ nn @ CRDT _{SP} win_num,x0,y0,x1,y1[result] _{CR LF}			
Get: ~ nn @ CRDT? _{SP} win_num _{CR LF}			
Parameters			
Set: win_num - 1-4; x0,y0 - top-left coordinate, x1, y1 - bottom-right coordinate			
Get: x0,x1 <=180 y0,y1 <=144(for PAL) y0,y1 <= 120(for NTSC) win_num = 1-4 or 0 (for output window)			
Response Triggers			
Notes			

Command - OVRL		Command Type - Multiviewer	
Command Name		Permission	Transparency
Set:	OVRL	End User	Public
Get	OVRL?	End User	Public
Description		Syntax	
Set:	Set text overlay parameters	#OVRL _{SP} stage, stage_id,mode,r,g,b,alpha _{CR}	
Get:	Get text overlay parameters	#OVRL? _{SP} stage, stage_id _{CR}	
Response			
~ _{nn} @OVRL _{SP} stage, stage_id,mode,r,g,b,alpha _{CR LF}			
Parameters			
<i>stage</i> - input/output (see Section 12.4 Stage) <i>stage_id</i> - number of chosen stage (1.. max number of inputs/outputs) <i>mode</i> - show/ hide text overlay string (see Section 12.1 On/Off) <i>r</i> - red component value (0-255) <i>g</i> - green component value (0-255) <i>b</i> - blue component value (0-255) <i>alpha</i> - alpha value (0-255)			
Response Triggers			
After execution, response is sent to the com port from which the Set/Get was received After execution, response is sent to all com ports if OVRL was set by any other external control device (button press, device menu and similar)			
Notes			

Command - OVRLBK		Command Type - Multiviewer	
Command Name		Permission	Transparency
Set:	OVRLBK	End User	Public
Get	OVRLBK?	End User	Public
Description		Syntax	
Set:	Set text overlay background parameters	# OVRLBK _[SP] <i>stage, stage_id,r,g,b,alpha</i> _[CR]	
Get:	Get text overlay background parameters	# OVRLBK? _[SP] <i>stage, stage_id</i> _[CR]	
Response			
~ _[n] @ OVRLBK _[SP] <i>stage, stage_id,r,g,b,alpha</i> _[CR LF]			
Parameters			
<i>stage</i> - input/output - set reference to Section 12.4 Stage <i>stage_id</i> - number of chosen stage (1.. max number of inputs/outputs) <i>r</i> - red component value (0-255) <i>g</i> - green component value (0-255) <i>b</i> - blue component value (0-255) <i>alpha</i> - alpha value (0-255)			
Response Triggers			
After execution, response is sent to the com port from which the Set/Get was received After execution, response is sent to all com ports if OVRLBK was set by any other external control device (button press, device menu and similar)			
Notes			

Command - OVRLTXT		Command Type - Multiviewer	
Command Name		Permission	Transparency
Set:	OVRLTXT	End User	Public
Get	OVRLTXT?	End User	Public
Description		Syntax	
Set:	Set overlay text	#OVRLTXT _{SP} stage,stage_id,type,size,x,y,string _{CR LF}	
Get:	Get overlay text	#OVRLTXT? _{SP} stage,stage_id _{CR}	
Response			
~ _{nn} @OVRLTXT _{SP} stage,stage_id,type,size,x,y,string _{CR LF}			
Parameters			
<i>stage</i> - input/output (see Section 12.4 Stage) <i>stage_id</i> - number of chosen stage (1.. max number of inputs/outputs) <i>type</i> - font type (only 0 supported currently, TBD) <i>size</i> - font size (see Section 12.8 Font Size) for values <i>x</i> - horizontal alignment (0 - Left, 1- Centered, 2- Right) <i>y</i> - vertical alignment (0 - Top, 1- Centered, 2- Bottom) <i>string</i> - tile text (up to 10 characters)			
Response Triggers			
After execution, response is sent to the com port from which the Set/Get was received After execution, response is sent to all com ports if OVRLTXT was set by any other external control device (button press, device menu and similar)			
Notes			

Command – SRC-BLANK		Command Type - Multiviewer	
Command Name		Permission	Transparency
Set:	SRC-BLANK	End User	Public
Get:	SRC-BLANK?	End User	Public
Description		Syntax	
Set:	Set window visibility	#SRC-BLANK _{SP} win_num,enable_flag _{CR}	
Get:	Get window visibility status	#SRC-BLANK? _{SP} win_num _{CR}	
Response			
~ _{nn} @ SRC-BLANK _{SP} win_num, enable_flag _{CR LF}			
Parameters			
<i>win_num</i> - window number to enable/disable <i>enable_flag</i> - See Section 12.1 On/Off			
Response Triggers			
After execution, response is sent to the com port from which the Set/Get was received After execution, response is sent to all com ports if SRC-BLANK was set by any other external control device (button press, device menu and similar)			
Notes			

Command - SRC-VID		Command Type - Multiviewer	
Command Name		Permission	Transparency
Set:	SRC-VID	End User	Public
Get	SRC-VID?	End User	Public
Description		Syntax	
Set:	Set window input	#SRC-VID _[SP] win_num,inp_num _[CR]	
Get:	Get window input	#SRC-VID? _[SP] win_num _[CR]	
Response			
~nn@SRC-VID _[SP] wnd_num, inp_num _[CR LF]			
Parameters			
<i>Wnd_num</i> - window number to set input			
<i>Inp_num</i> – input number (1... max number of inputs)			
Response Triggers			
After execution, response is sent to the com port from which the Set/Get was received			
After execution, response is sent to all com ports if SRC-VID was set by any other external control device (button press, device menu and similar)			
Notes			

Command - WIN		Command Type - Multiviewer	
Command Name		Permission	Transparency
Set:	WIN	End User	Public
Get	WIN?	End User	Public
Description		Syntax	
Set:	Set active window	# WIN _[SP] win_num _[CR]	
Get:	Get active window	# WIN? _[CR]	
Response			
~nn@WIN _[SP] win_num _[CR LF]			
Parameters			
<i>win_num</i> - window number setting active			
Response Triggers			
After execution, response is sent to the com port from which the Set/Get was received			
After execution, response is sent to all com ports if WIN was set by any other external control device (button press, device menu and similar)			
Notes			

Command - WND-BRD		Command Type - Multiviewer	
Command Name		Permission	Transparency
Set:	WND-BRD	End User	Public
Get	WND-BRD?	End User	Public
Description		Syntax	
Set:	Enable/ Disable window border	#WND-BRD _[SP] win_num _[CR] enable _[CR]	
Get:	Get window border status	#WND-BRD? _[SP] win_num _[CR]	
Response			
~ [nn] @WND-BRD _[SP] id, switch, ColSpace, p1, p2, p3 _[CR LF]			
Parameters			
id - window id switch - enable/disable border, see Section 12.1 On/Off ColSpace - See Section 12.2 Color Space . P1, P2, P3 - R, G, B (ot Y, Cb, Cr) components for color, defined in the User Manual			
Response Triggers			
After execution, response is sent to the com port from which the Set/Get was received After execution, response is sent to all com ports if WND-BRD was set by any other external control device (button press, device menu and similar)			
Notes			

Command - WND-FRZ		Command Type - Multiviewer	
Command Name		Permission	Transparency
Set:	WND-FRZ	End User	Public
Get	WND-FRZ?	End User	Public
Description		Syntax	
Set:	Set freeze on selected window	#WND-FRZ _[SP] win_num _[CR] freeze_flag _[CR]	
Get:	Get window freeze status	#WND-FRZ? _[SP] win_num _[CR]	
Response			
~ [nn] @WND-FRZ _[SP] win_num, freeze_flag _[CR LF]			
Parameters			
win_num - window number to enable/disable freeze_flag - see Section 12.1 On/Off			
Response Triggers			
After execution, response is sent to the com port from which the Set/Get was received After execution, response is sent to all com ports if WND-FRZ was set by any other external control device (button press, device menu and similar)			
Notes			

Command - WND-LR		Command Type - Multiviewer	
Command Name		Permission	Transparency
Set:	WND-LR	End User	Public
Get:	WND-LR?	End User	Public
Description		Syntax	
Set:	Set window overlay order	# WND-LR _{SP} <i>win_num,value</i> _{CR}	
Get:	Get window overlay order	# WND-LR? _{SP} <i>win_num</i> _{CR}	
Response			
~ <i>nn</i> @ WND-LR _{SP} <i>win_num,value</i> _{CR LF}			
Parameters			
<i>win_num</i> - window number setting layer <i>value</i> - overlay order number			
Response Triggers			
After execution, response is sent to the com port from which the Set/Get was received After execution, response is sent to all com ports if WND-LR was set by any other external control device (button press, device menu and similar)			
Notes			
In case of the overlay order list, the number of expected layers the is maximum number of windows in device			

Command - WND-ALL_LR		Command Type - Multiviewer	
Command Name		Permission	Transparency
Set:	WND-ALL_LR	End User	Public
Get:	WND-ALL_LR?	End User	Public
Description		Syntax	
Set:	Set all window overlay order	# WND-ALL_LR _{SP} <i>value1,value2,...,valueN</i> _{CR}	
Get:	Get all window overlay order	# WND-ALL_LR? _{SP CR}	
Response			
~ <i>nn</i> @ WND-ALL_LR _{SP} <i>value1,value2,...,valueN</i> _{CR LF}			
Parameters			
<i>value</i> - overlay order number			
Response Triggers			
After execution, response is sent to the com port from which the set/get was received After execution, response is sent to all com ports if WND-ALL_LR was set by any other external control device (button press, device menu and similar)			
Notes			
In case of the overlay order list, the number of expected layers the is maximum number of windows in device			

11.5 Communication Commands

Command	Description	Type	Permission
ETH-PORT	Set/get Ethernet port protocol	Communication	Administrator
NET-DHCP	Set/get DHCP mode	Communication	Administrator
NET-GATE	Set/get gateway IP	Communication	Administrator
NET-IP	Set/get IP address	Communication	Administrator
NET-MAC?	Get MAC address	Communication	End User
NET-MASK	Set/get subnet mask	Communication	Administrator

Command - ETH-PORT		Command Type - Communication	
Command Name		Permission	Transparency
Set:	ETH-PORT	Administrator	Public
Get:	ETH-PORT?	End User	Public
Description		Syntax	
Set:	Set Ethernet port protocol	# ETH-PORT _[SP] <i>portType</i> , <i>ETHPort</i> , <i>portNum</i> _[CR]	
Get:	Get Ethernet port protocol	# ETH-PORT? _[SP] <i>portType</i> , <i>portNum</i> _[CR]	
Response			
~ [nn] @ ETH-PORT _[SP] <i>portType</i> , <i>ETHPort</i> , <i>portNum</i> _[CR LF]			
Parameters			
<i>portNum</i> - 1-4 TCP/UDP port enumerator (equals the connected com port number from the tunneling port)			
<i>portType</i> - TCP/UDP			
<i>ETHPort</i> - TCP/UDP port number			
Response Triggers			
Notes			

Command - NET-DHCP		Command Type - Communication	
Command Name		Permission	Transparency
Set:	NET-DHCP	Administrator	Public
Get:	NET-DHCP?	End User	Public
Description		Syntax	
Set:	Set DHCP mode	#NET-DHCP _{SP} mode _{CR}	
Get:	Get DHCP mode	#NET-DHCP? _{CR}	
Response			
Set:	~nn@ NET-DHCP _{SP} mode _{SP} OK _{CR LF}		
Get:	~nn@ NET-DHCP _{SP} mode _{CR LF}		
Parameters			
mode - 0 - Do not use DHCP. Use the IP set by the factory or using the IP set command 1 - Try to use DHCP. If unavailable, use IP as above			
Response Triggers			
Notes			
Connecting Ethernet to devices with DHCP may take more time in some networks To connect with a randomly assigned IP by DHCP, specify the device DNS name (if available) using the command "NAME". You can also get an assigned IP by direct connection to USB or RS-232 protocol port if available For proper settings consult your network administrator			

Command - NET-GATE		Command Type - Communication	
Command Name		Permission	Transparency
Set:	NET-GATE	Administrator	Public
Get:	NET-GATE?	End User	Public
Description		Syntax	
Set:	Set gateway IP	#NET-GATE _{SP} ip_address _{CR}	
Get:	Get gateway IP	#NET-GATE? _{CR}	
Response			
Set:	~nn@NET-GATE _{SP} ip_address _{SP} OK _{CR LF}		
Get:	~nn@NET-GATE _{SP} ip_address _{CR LF}		
Parameters			
ip_address - format: xxx.xxx.xxx.xxx			
Response Triggers			
Notes			
A network gateway connects the device via another network and maybe over the Internet. Be careful of security problems. For proper settings consult your network administrator			

Command - NET-IP		Command Type - Communication	
Command Name		Permission	Transparency
Set:	NET-IP	Administrator	Public
Get:	NET-IP?	End User	Public
Description		Syntax	
Set:	Set IP address	# NET-IP _[SP] <i>ip_address</i> _[CR]	
Get:	Get IP address	# NET-IP? _[CR]	
Response			
Set:	~ nn @ NET-IP _[SP] <i>ip_address</i> _[SP] OK _[CR LF]		
Get:	~ nn @ NET-IP _[SP] <i>ip_address</i> _[CR LF]		
Parameters			
<i>ip_address</i> - format: xxx.xxx.xxx.xxx			
Response Triggers			
Notes			
For proper settings consult your network administrator			

Command - NET-MAC?		Command Type - Communication	
Command Name		Permission	Transparency
Set:	-	-	-
Get:	NET-MAC?	End User	Public
Description		Syntax	
Set:	-	-	
Get:	Get MAC address	# NET-MAC? _[CR]	
Response			
~ nn @ NET-MAC? _[SP] <i>mac_address</i> _[CR LF]			
Parameters			
<i>mac_address</i> - Unique MAC address. Format: XX-XX-XX-XX-XX-XX where X is hex digit			
Response Triggers			
Notes			

Command - NET-MASK		Command Type - Communication	
Command Name		Permission	Transparency
Set:	NET-MASK	Administrator	Public
Get:	NET-MASK?	End User	Public
Description		Syntax	
Set:	Set subnet mask	# NET-MASK _[SP] <i>net_mask</i> _[CR]	
Get:	Get subnet mask	# NET-MASK? _[CR]	
Response			
Set:	~ _[nn] @ NET-MASK _[SP] <i>net_mask</i> _[SP] OK _[CR LF]		
Get:	~ _[nn] @ NET-MASK _[SP] <i>net_mask</i> _[CR LF]		
Parameters			
<i>net_mask</i> - format: xxx.xxx.xxx.xxx			
Response Triggers			
The subnet mask limits the Ethernet connection within the local network For proper settings consult your network administrator			
Notes			

12 Parameters

12.1 On/Off

Number	Value
0	Off
1	On

12.2 Color Space

Number	Value
0	RGB
1	YCbCr 4:2:2
2	YCbCr 4:4:4

12.3 Genlock Types

Number	Value
0	Free run
1	Digital
2	Analog

12.4 Stage

Number	Value
0	Input
1	Output
2	(Reserved)
3	(Reserved)

12.5 Video Resolutions

VIC Number	Resolution
0	No Signal (for input) / Native - EDID (for output)
1	640x480p @59.94Hz/60Hz
2	720x480p @59.94Hz/60Hz
3	720x480p @59.94Hz/60Hz
4	1280x720p @59.94Hz/60Hz
5	1920x1080i @59.94Hz/60Hz
6	720(1440)x480i @59.94Hz/60Hz
7	720(1440)x480i @59.94Hz/60Hz
8	720(1440)x240p @59.94Hz/60Hz
9	720(1440)x240p @59.94Hz/60Hz
10	2880x480i @59.94Hz/60Hz

VIC Number	Resolution
11	2880x480i @59.94Hz/60Hz
12	2880x240p @59.94Hz/60Hz
13	2880x240p @59.94Hz/60Hz
14	1440x480p @59.94Hz/60Hz
15	1440x480p @59.94Hz/60Hz
16	1920x1080p @59.94Hz/60Hz
17	720x576p @50Hz
18	720x576p @50Hz
19	1280x720p @50Hz
20	1920x1080i @50Hz
21	720(1440)x576i @50Hz
22	720(1440)x576i @50Hz
23	720(1440)x288p @50Hz
24	720(1440)x288p @50Hz
25	2880x576i @50Hz
26	2880x576i @50Hz
27	2880x288p @50Hz
28	2880x288p @50Hz
29	1440x576p @50Hz
30	1440x576p @50Hz
31	1920x1080p @50Hz
32	1920x1080p @23.97Hz/24Hz
33	1920x1080p @25Hz
34	1920x1080p @29.97Hz/30Hz
35	2880x480p @59.94Hz/60Hz
36	2880x480p @59.94Hz/60Hz
37	2880x576p @50Hz
38	2880x576p @50Hz
39	1920x1080i @50Hz
40	1920x1080i @100Hz
41	1280x720p @100Hz
42	720x576p @100Hz
43	720x576p @100Hz
44	720(1440)x576i @100Hz
45	720(1440)x576i @100Hz
46	1920x1080i @119.88/120Hz
47	1280x720p @119.88/120Hz
48	720x480p @119.88/120Hz
49	720x480p @119.88/120Hz
50	720(1440)x480i @119.88/120Hz
51	720(1440)x480i @119.88/120Hz
52	720x576p @200Hz

VIC Number	Resolution
53	720x576p @200Hz
54	720(1440)x576i @200Hz
55	720(1440)x576i @200Hz
56	720x480p @239.76/240Hz
57	720x480p @239.76/240Hz
58	720(1440)x480i @239.76/240Hz
59	720(1440)x480i @239.76/240Hz
60	1280x720p @23.97Hz/24Hz
61	1280x720p @25Hz
62	1280x720p @29.97Hz/30Hz
63	1920x1080p @119.88/120Hz
64	1920x1080p @100Hz
65-100	(Reserved)
100	Custom resolution 1
101	Custom resolution 2
102	Custom resolution 3
103	Custom resolution 4
104	Custom resolution 5
104-254	(Reserved)

12.6 Custom Resolution Parameters

Number	Value
0	Width
1	Height
2	HTotal
3	VTTotal
4	HSync width
5	HSync back porch
6	VSyn width
7	VSyn back porch
8	Frame rate
9	Interlaced (0)/Progressive (1)

12.7 View Modes

Number	Value
0	PIP off
1	PIP on
2	Preview

12.8 Font Size

Number	Value
0	Small
1	Medium
2	Large

LIMITED WARRANTY

The warranty obligations of Kramer Electronics for this product are limited to the terms set forth below:

What is Covered

This limited warranty covers defects in materials and workmanship in this product.

What is Not Covered

This limited warranty does not cover any damage, deterioration or malfunction resulting from any alteration, modification, improper or unreasonable use or maintenance, misuse, abuse, accident, neglect, exposure to excess moisture, fire, improper packing and shipping (such claims must be presented to the carrier), lightning, power surges, or other acts of nature. This limited warranty does not cover any damage, deterioration or malfunction resulting from the installation or removal of this product from any installation, any unauthorized tampering with this product, any repairs attempted by anyone unauthorized by Kramer Electronics to make such repairs, or any other cause which does not relate directly to a defect in materials and/or workmanship of this product. This limited warranty does not cover cartons, equipment enclosures, cables or accessories used in conjunction with this product.

Without limiting any other exclusion herein, Kramer Electronics does not warrant that the product covered hereby, including, without limitation, the technology and/or integrated circuit(s) included in the product, will not become obsolete or that such items are or will remain compatible with any other product or technology with which the product may be used.

How Long Does this Coverage Last

Seven years as of this printing; please check our Web site for the most current and accurate warranty information.

Who is Covered

Only the original purchaser of this product is covered under this limited warranty. This limited warranty is not transferable to subsequent purchasers or owners of this product.

What Kramer Electronics will do

Kramer Electronics will, at its sole option, provide one of the following three remedies to whatever extent it shall deem necessary to satisfy a proper claim under this limited warranty:

1. Elect to repair or facilitate the repair of any defective parts within a reasonable period of time, free of any charge for the necessary parts and labor to complete the repair and restore this product to its proper operating condition. Kramer Electronics will also pay the shipping costs necessary to return this product once the repair is complete.
2. Replace this product with a direct replacement or with a similar product deemed by Kramer Electronics to perform substantially the same function as the original product.
3. Issue a refund of the original purchase price less depreciation to be determined based on the age of the product at the time remedy is sought under this limited warranty.

What Kramer Electronics will not do Under This Limited Warranty

If this product is returned to Kramer Electronics or the authorized dealer from which it was purchased or any other party authorized to repair Kramer Electronics products, this product must be insured during shipment, with the insurance and shipping charges prepaid by you. If this product is returned uninsured, you assume all risks of loss or damage during shipment. Kramer Electronics will not be responsible for any costs related to the removal or re-installation of this product from or into any installation. Kramer Electronics will not be responsible for any costs related to any setting up this product, any adjustment of user controls or any programming required for a specific installation of this product.

How to Obtain a Remedy under this Limited Warranty

To obtain a remedy under this limited warranty, you must contact either the authorized Kramer Electronics reseller from whom you purchased this product or the Kramer Electronics office nearest you. For a list of authorized Kramer Electronics resellers and/or Kramer Electronics authorized service providers, please visit our web site at www.kramerelectronics.com or contact the Kramer Electronics office nearest you.

In order to pursue any remedy under this limited warranty, you must possess an original, dated receipt as proof of purchase from an authorized Kramer Electronics reseller. If this product is returned under this limited warranty, a return authorization number, obtained from Kramer Electronics, will be required. You may also be directed to an authorized reseller or a person authorized by Kramer Electronics to repair the product.

If it is decided that this product should be returned directly to Kramer Electronics, this product should be properly packed, preferably in the original carton, for shipping. Cartons not bearing a return authorization number will be refused.

Limitation on Liability

THE MAXIMUM LIABILITY OF KRAMER ELECTRONICS UNDER THIS LIMITED WARRANTY SHALL NOT EXCEED THE ACTUAL PURCHASE PRICE PAID FOR THE PRODUCT. TO THE MAXIMUM EXTENT PERMITTED BY LAW, KRAMER ELECTRONICS IS NOT RESPONSIBLE FOR DIRECT, SPECIAL, INCIDENTAL OR CONSEQUENTIAL DAMAGES RESULTING FROM ANY BREACH OF WARRANTY OR CONDITION, OR UNDER ANY OTHER LEGAL THEORY. Some countries, districts or states do not allow the exclusion or limitation of relief, special, incidental, consequential or indirect damages, or the limitation of liability to specified amounts, so the above limitations or exclusions may not apply to you.

Exclusive Remedy

TO THE MAXIMUM EXTENT PERMITTED BY LAW, THIS LIMITED WARRANTY AND THE REMEDIES SET FORTH ABOVE ARE EXCLUSIVE AND IN LIEU OF ALL OTHER WARRANTIES, REMEDIES AND CONDITIONS, WHETHER ORAL OR WRITTEN, EXPRESS OR IMPLIED. TO THE MAXIMUM EXTENT PERMITTED BY LAW, KRAMER ELECTRONICS SPECIFICALLY DISCLAIMS ANY AND ALL IMPLIED WARRANTIES, INCLUDING, WITHOUT LIMITATION, WARRANTIES OF MERCHANTABILITY AND FITNESS FOR A PARTICULAR PURPOSE. IF KRAMER ELECTRONICS CANNOT LAWFULLY DISCLAIM OR EXCLUDE IMPLIED WARRANTIES UNDER APPLICABLE LAW, THEN ALL IMPLIED WARRANTIES COVERING THIS PRODUCT, INCLUDING WARRANTIES OF MERCHANTABILITY AND FITNESS FOR A PARTICULAR PURPOSE, SHALL APPLY TO THIS PRODUCT AS PROVIDED UNDER APPLICABLE LAW.

IF ANY PRODUCT TO WHICH THIS LIMITED WARRANTY APPLIES IS A "CONSUMER PRODUCT" UNDER THE MAGNUSON-MOSS WARRANTY ACT (15 U.S.C.A. §2301, ET SEQ.) OR OTHER APPLICABLE LAW, THE FOREGOING DISCLAIMER OF IMPLIED WARRANTIES SHALL NOT APPLY TO YOU, AND ALL IMPLIED WARRANTIES ON THIS PRODUCT, INCLUDING WARRANTIES OF MERCHANTABILITY AND FITNESS FOR THE PARTICULAR PURPOSE, SHALL APPLY AS PROVIDED UNDER APPLICABLE LAW.

Other Conditions

This limited warranty gives you specific legal rights, and you may have other rights which vary from country to country or state to state.

This limited warranty is void if (i) the label bearing the serial number of this product has been removed or defaced, (ii) the product is not distributed by Kramer Electronics or (iii) this product is not purchased from an authorized Kramer Electronics reseller. If you are unsure whether a reseller is an authorized Kramer Electronics reseller, please visit our Web site at www.kramerelectronics.com or contact a Kramer Electronics office from the list at the end of this document.

Your rights under this limited warranty are not diminished if you do not complete and return the product registration form or complete and submit the online product registration form. Kramer Electronics thanks you for purchasing a Kramer Electronics product. We hope it will give you years of satisfaction.



For the latest information on our products and a list of Kramer distributors, visit our Web site where updates to this user manual may be found.

We welcome your questions, comments, and feedback.

Web site: www.kramerelectronics.com

E-mail: info@kramerel.com

CE



SAFETY WARNING

Disconnect the unit from the power supply before opening and servicing



P/N: 2900-000737



Rev: 11