



**C2-3300 Series
Universal Input
Video Processor Operation Manual**

C2-3300 SERIES OPERATION MANUAL

C2-3300 SERIES OPERATION MANUAL

TABLE OF CONTENTS

1	DISCLAIMER	1
1.1	Regulatory Agency Acceptance.....	1
1.2	FCC Statement.....	1
1.3	Manual Version Information.....	2
1.4	Manual Copyright Notice	2
2	IMPORTANT SAFETY INSTRUCTION.....	3
3	CAPABILITY, DEVICE FEATURES AND PRODUCT FEATURES.....	13
3.1	Device Capabilities.....	13
3.2	Device Features	14
4	PRODUCT IMAGES	16
5	UNPACKING AND INSTALLATION.....	17
5.1	Furnished Accessories	17
5.2	Important Safety Instructions.....	17
5.3	Factory Reset.....	18
5.4	Initial Video Operation Check.....	18
5.5	Initial Audio Operation Check.....	19
6	FRONT PANEL CONTROLS	20
6.1	Button controls	20
6.2	Multi-directional switch	21
6.3	Advanced menus.....	21
6.4	Special button combinations and functions.....	21
6.4.1	Locking front panel buttons & IR remote control.....	21
6.4.2	Restore power-on settings.....	22
6.4.3	Factory Reset.....	22
7	VIDEO INPUTS AND OUTPUTS	23
7.1	Video inputs	23
7.2	Video outputs.....	24
7.3	Audio inputs and outputs	24
8	INFRA-RED REMOTE CONTROL.....	26
9	MENU LAYOUT AND SETTINGS ADJUSTMENT	27
9.1	The High Level Menu Structure	27
9.2	Group Names and Descriptions.....	28
9.3	Items Associated with the Adjust outputs group.....	29
9.4	Items Associated with the Adjust windows group.....	32

C2-3300 SERIES OPERATION MANUAL

9.4.1	Extended scaling controls.....	36
9.4.2	'Aspect adjust' = 'Advanced'.....	36
9.4.3	'Aspect adjust' = 'Pixel'.....	37
9.5	Items Associated with the Adjust keyers group.....	38
9.6	Edge Blend items within the Adjust keyers group.....	39
9.7	Items Associated with the Adjust sources group.....	40
9.7.1	Menu items common to all inputs.....	41
9.7.2	DVI Source Menu Items.....	44
9.7.3	RGB Source Menu Items.....	46
9.7.4	CV & YC Source Menu Items.....	47
9.7.5	Still Image Store / Testcard Source Menu Items.....	48
9.8	Items associated with the Adjust transitions group.....	48
9.9	Items Associated with the Adjust buttons group.....	49
9.10	Items associated with the Adjust ethernet group.....	50
9.11	Items associated with the Adjust resolutions group.....	51
9.12	Items Associated with the System group.....	54
10	RS232 PORT.....	58
10.1	Connection.....	58
10.2	Communications protocol.....	58
11	RS232 / IP CONTROL SPECIFICATION.....	59
11.1	Communication protocol basics.....	59
11.2	Packet format.....	60
11.3	Function list.....	62
11.4	Examples.....	69
11.5	Reading and writing macros.....	70
11.5.1	Reading a previously stored Macro.....	70
11.5.2	Writing to a macro.....	71
11.5.3	Run and Restore macros.....	71
12	COMMON OPERATIONS.....	73
12.1	Operation of the Keyer.....	73
12.1.1	Preparation:.....	73
12.1.2	Adjustment:.....	73
13	EDGE-BLENDING SETUP.....	75
13.1	Introduction.....	75
13.2	Edge-blending requirements.....	76
13.3	Basic setup of the two projectors.....	77

C2-3300 SERIES OPERATION MANUAL

13.4	Connections to the scaler(s) and projectors.....	77
13.5	Initial setup.....	78
13.6	Edge-blending activation.....	79
13.7	Edge-blending overlap / size.....	79
13.8	Edge-blending guide lines.....	80
13.9	Alignment of projectors.....	81
13.10	Gamma correction.....	83
13.11	Brightness compensation.....	83
13.12	Aspect ratio adjustment.....	84
13.13	Locking both outputs together.....	84
13.14	Other setup approaches.....	85
14	WINDOWS CONTROL PANEL.....	88
14.1	Opening screens.....	88
14.1.1	Selecting a serial port connection.....	88
14.1.2	Selecting an Ethernet connection.....	88
14.2	Connecting to a unit.....	89
14.3	Application menu's.....	91
14.3.1	File menu.....	91
14.3.2	Communications menu.....	91
14.3.3	Tools menu.....	92
14.3.4	Resolution menu.....	92
14.4	Scripting tool.....	92
14.5	Image Loader.....	93
14.5.1	Loading Still Images / Testcards.....	94
14.5.2	Loading Logos.....	95
14.5.3	Maximum Image size – how large can my Logo / Still Image / Testcard be?.....	96
14.6	Resolution Editor.....	96
15	TROUBLESHOOTING AND TECHNICAL SUPPORT.....	100
15.1	There is no picture on the Output.....	100
15.2	The image is shifted and not fully viewable.....	100
15.3	The output resolutions no longer appear as expected.....	100
15.4	There is excessive flicker on the Output.....	101
15.5	The Output image is distorted.....	101
15.6	Some colors appear to be incorrect on the CV/YC output.....	101
15.7	How can I reduce color smearing on CV connections?.....	101
15.8	I can no longer adjust the Output image resolution.....	101

C2-3300 SERIES OPERATION MANUAL

15.9	The picture on the video display is black and white.....	101
15.10	The picture on the video display is green.....	101
15.11	The RGB input is selected but the image is rolling or pink.....	102
15.12	The video signal from my DVD player does not appear to work.....	102
15.13	The output from the 1T-CT-464 is blue.....	102
15.14	No video present from the UTP output.....	102
16	RETURN PROCEDURE	103
16.1	Are you sure there's a fault?.....	103
16.2	To return a unit for repair	103
17	WARRANTY POLICY	105
18	CONNECTOR PINOUTS	106
18.1	DVI-I connector	106
18.2	HD15 connector	106
18.3	RS232 / D9 socket.....	107
18.4	4 Pin mini-DIN S-video connector (YC) input.....	107
18.5	Multi-way audio connector (balanced).....	107
19	SPECIFICATIONS	108
19.1	Universal Inputs.....	108
19.2	Universal Outputs.....	108
19.3	Audio input/output (C2-3310 / C2-3360 only).....	109
19.4	Locking/Mixing (C2-3350 / C2-3360 only)	109
19.5	Scaling / sampling / memory.....	109
19.6	Warranty.....	109
19.7	Regulatory Compliance	109
19.8	Environmental	109
19.9	Power Requirement.....	110
19.10	Control Methods	110
19.11	Accessories Included.....	110
19.12	Mechanical.....	110
19.13	Optional Accessories.....	110
20	CONTACT INFORMATION.....	111

1 DISCLAIMER

This product is intended for professional and/or home use. This product is not intended for use in a medical environment and does not have the required certifications for such use. Similarly, use aboard any aircraft or spacecraft while in flight or as an adjunct to any surface, airborne or marine navigation system or any offshore marine activity, including control of any watercraft, or any use similar to those specifically herein mentioned is prohibited. Use in the aforementioned circumstances would require additional testing and certification.

You have not become the owner of any software - you have merely purchased the right to use the software. You may make one copy of the software for your own use. Other copies will be deemed a breach of copyright.

No warranty is made either expressed or implied including but not limited to any implied warranties of merchantability or fitness for a particular purpose. In no event shall the supplier or manufacturer of this product be liable for errors found within, or be liable for any direct, indirect or consequential damages or loss in connection with the purchase or use of this hardware software or manual. The sole and exclusive liability to the supplier and manufacturer regardless of the form of action shall not exceed the replacement cost of the materials described herein.

By using this equipment you have indicated that you have agreed to the terms listed above. If you do not wish to agree or the above terms are contrary to your conditions of purchase you may return the equipment, unused, to your supplier. All trademarks and copyrights are acknowledged. E&OE.

1.1 Regulatory Agency Acceptance

European 'CE' Mark Statement

Emissions: BS EN 61000-6-3:2001 (Generic Immunity Standard for Residential, Commercial and Light Industrial)

Immunity: BS EN 61000-6-1:2001 (Generic Immunity Standard for Residential, Commercial and Light Industrial)

1.2 FCC Statement

Class A Device: This equipment has been tested and found to comply with the limits for a Class A digital device pursuant to Part 15 of the FCC Rules. These limits are designed to provide a reasonable protection against harmful interference when the equipment is operated in a commercial environment. This equipment generates, uses and can radiate radio frequency energy and, if not installed and used in accordance with the Instruction Manual, may cause harmful interference to radio communications. Operation of this equipment in a residential area is likely to cause harmful interference in which case the user will be required to correct the interference at his own expense.

C2-3300 SERIES OPERATION MANUAL

Caution: This equipment is intended for use in the manner prescribed in the Instruction Manual. Any user changes or modifications not expressly approved by TV One Multimedia Solutions could void the user's authority to operate the equipment. Connecting this equipment to external devices requires no specially shielded cabling for FCC compliance. The Instruction Manual shows or describes the proper connection of this equipment for operation that insures FCC compliance.

Direct all inquiries regarding FCC compliance to:

TV One Multimedia Solutions
1350 Jamike Drive
Erlanger, KY 41018
859.282.7303
859.282.8225 (Fax)

1.3 Manual Version Information

Version: 2.7
Release Date: May, 2009

1.4 Manual Copyright Notice

This Operation Manual is the intellectual property of TV One, ©2006, 2007, 2008, 2009. No portion of this manual may be copied or reproduced in any manner or by any means, including, but not limited to electronic and electro-mechanical, without the express written permission of TV One.

2 IMPORTANT SAFETY INSTRUCTION

To insure the best from this product, please read this manual carefully. Keep it in a safe place for future reference.

To reduce the risk of electric shock, do not remove the cover from the unit. No user serviceable parts inside. Refer servicing to qualified personnel.

2.1 Power and connections

This unit must be connected to a mains socket outlet with a protective earth connection.

This unit is not disconnected from the AC power source as long as it is connected to the wall outlet. The off state for this unit is called standby mode. In standby mode the unit is designed to consume a reduced quantity of power compared to normal operating modes.

When not using the unit for a long period of time, insure that the AC power cord is disconnected from the wall outlet.

The AC wall outlet should be installed near to the unit and be easily accessible.

Do not plug in or attempt to operate an obviously damaged unit.

2.2 Water and moisture

To reduce the risk of fire and personal injury, operation of this device outdoors and/or exposure to rain, water or excessive moisture is expressly prohibited.

The apparatus shall not be exposed to dripping or splashing and no objects filled with liquids, such as vases, shall be placed on the apparatus.

2.3 General care

Do not force switches or external connections.

When moving the unit, disconnect the serial port connections first then the power cable and finally the interconnecting cables to other devices.

Do not attempt to clean the unit with chemical solvents or aerosol cleaners, as this may damage the unit. Use a clean dry cloth.

2.4 Location

Installation of this unit should be in a cool dry place, away from sources of excessive heat, vibration, dust, moisture and cold.

2.5 Ventilation

Slots and openings in the sides of the unit are provided for ventilation. To ensure reliable operation, avoid obstruction of these openings and ensure the unit is installed in a well-ventilated area.

2.6 Intellectual property

Some IC chips in this product include confidential and/or trade secret property. Therefore you may not copy, modify, adapt, translate, distribute, reverse engineer, reverse assemble or decompile the contents thereof.

2 IMPORTANT: CONSIGNES DE SECURITE

Afin de tirer le meilleur de ce produit, merci de lire attentivement ce manuel. Gardez-le dans un endroit sûr pour pouvoir le consulter à nouveau.

Afin de réduire le risque de choc électrique, ne retirez pas l'unité de sa protection.

Aucune pièce réparable par l'utilisateur à l'intérieur. Référez-vous à des personnes qualifiées.

2.1 Alimentation électrique et connexions

Il faut brancher l'appareil sur une prise du secteur disposant d'une mise à la terre.

Cette unité n'est pas déconnectée de la source de courant électrique tant qu'elle est connectée à la prise murale. Le mode éteint de cette unité est appelé mode de veille. En mode de veille, cette unité est conçue pour consommer une quantité réduite de courant par rapport aux modes normaux d'utilisation.

Lorsque vous n'utilisez pas l'unité pendant une longue période, assurez-vous que le câble d'alimentation électrique est déconnecté de la prise murale.

La prise murale de courant doit être installée près de l'unité et aisément accessible.

Ne branchez pas et n'essayez pas d'utiliser une unité visiblement endommagée.

2.2 Eau et humidité

Pour réduire les risques d'incendie et de dommages corporels, l'utilisation de cet appareil à l'extérieur et/ou son exposition à la pluie, l'eau ou une humidité excessive est expressément interdite.

L'appareil ne doit pas être exposé aux gouttes ou aux éclaboussures et aucun objet contenant de l'eau, comme par exemple un vase, ne doit être posé sur l'appareil.

2.3 Entretien général

Ne forcez pas les boutons ou connexions externes.

Lorsque vous déplacez l'unité, déconnectez d'abord les connexions de ports en série puis le câble d'alimentation et enfin les câbles de connexion avec d'autres appareils.

N'essayez pas de nettoyer l'unité avec des dissolvants chimiques ou des produits nettoyants en aérosol, car cela peut endommager l'unité. Utilisez un chiffon propre et sec.

2.4 Emplacement

L'installation de cette unité doit se faire dans un endroit frais et sec, éloigné de sources excessives de chaleur, de vibrations, de poussière, d'humidité et de froid.

2.5 Aération

Les rainures et les ouvertures sur les cotés de l'unité servent à l'aérer. Pour permettre une utilisation sûre, évitez d'obstruer ces ouvertures et assurez-vous que l'unité est installée dans un endroit bien aéré.

2.6 Propriété intellectuelle

Certaines puces IC dans ce produit contiennent des éléments propriétaires confidentiels et/ou des secrets commerciaux. Vous ne devez donc pas copier, modifier, adapter, traduire, distribuer, démonter, désassembler, ou décomposer leur contenu.

2 INSTRUCCIONES IMPORTANTES DE SEGURIDAD

Para sacar el mejor provecho de este producto, léase este manual con detenimiento. Guárdelo en un lugar seguro para poder hacerle referencia en el futuro.

Para reducir el riesgo de calambre, no quite la cubierta del aparato.

No hay piezas utilizables dentro. Remítase todo mantenimiento a personal cualificado.

2.1 Corriente y conexiones

Esta unidad debe estar conectada a una toma de corriente eléctrica con una conexión a tierra de protección.

Mientras esté conectada a una toma de electricidad, el aparato seguirá conectado a la fuente de corriente CA. A la posición de «off» de este aparato se le denomina posición de espera. En la posición de espera, el aparato está diseñado a consumir una cantidad reducida de electricidad en comparación con los modos de operación normales.

Asegúrese de desconectar el cable de corriente CA de la toma de la pared cuando no va a utilizar el aparato por un periodo largo de tiempo.

La toma CA de la pared ha de estar instalada cerca del aparato y debe ser fácilmente accesible.

No enchufe ni intente operar un aparato que esté evidentemente dañado.

2.2 Agua y humedad

Para reducir el riesgo de fuego o de daños personales, se prohíbe la utilización de este aparato en el exterior y/o su exposición a la lluvia, al agua o a atmósferas de excesiva humedad.

El aparato no debe situarse cerca de zonas en las que haya riesgo de goteo o salpicaduras. Tampoco deben colocarse objetos que contengan agua (jarrones, por ejemplo) en el mismo.

2.3 Cuidado general

No forzar interruptores o conexiones externas.

Al mover el aparato, desconecte las conexiones del puerto en serie primero, luego el cable de electricidad y finalmente los cables interconectados a otros aparatos. No intente limpiar el aparato con disolventes químicos o productos de limpieza aerosol, ya que podrían dañar el aparato. Utiliza un paño limpio y seco.

2.4 Ubicación

Este aparato se debe instalar en un lugar seco y fresco, lejos de fuentes de calor excesivas, la vibración, el polvo, la humedad y el frío.

2.5 Ventilación

El aparato viene provisto de ranuras y agujeros en los lados para la ventilación.

Para asegurar una operación eficaz, se debe evitar la obstrucción de estos agujeros y también asegurar que el aparato se instale en una zona con adecuada ventilación.

2.6 Propiedad intelectual

Algunos chips con circuito integrado de este producto incluyen propiedad confidencial y/o propiedad de secreto comercial. Por lo tanto queda prohibido copiar, modificar, adaptar, traducir, distribuir, usar técnicas retroactivas, desmontar, o recopilar los contenidos del mismo.

2 WICHTIGE SICHERHEITSVORSCHRIFTEN

Lesen Sie diese Bedienungsanleitung bitte sorgfältig, um Ihr Produkt optimal nützen zu können, und bewahren Sie sie zum späteren Nachschlagen an einem sicheren Ort auf.

Entfernen Sie bitte keinesfalls die Abdeckung, um der Gefahr eines Stromschlags vorzubeugen.

Im Inneren des Geräts befinden sich keine Teile, die vom Benutzer gewartet werden können. Lassen Sie Wartungsarbeiten nur von Fachpersonal durchführen.

2.1 Stromversorgung und anschlüsse

Das Gerät muss an eine geerdete Netzsteckdose angeschlossen werden.

Solange das Gerät mit einer Steckdose verbunden ist, bleibt die Stromversorgung aufrecht. Der Ausschaltzustand des Geräts wird als Standbymodus bezeichnet. Im Standbymodus verbraucht das Gerät weniger Strom als in den üblichen Betriebsarten.

Wird das Gerät über einen längeren Zeitraum hinweg nicht verwendet, ziehen Sie bitte das Stromkabel aus der Steckdose.

Die Steckdose sollte sich in der Nähe des Geräts befinden und leicht zugänglich sein.

Verbinden Sie ein offensichtlich beschädigtes Gerät keinesfalls mit einer Steckdose und versuchen Sie auch nicht, es zu bedienen.

2.2 Wasser und feuchtigkeit

Um die Gefahr eines Brandes oder einer Körperverletzung zu verringern, ist es ausdrücklich verboten, dieses Gerät im Freien in Betrieb zu nehmen und/oder es Regen, Wasser oder hoher Feuchtigkeit auszusetzen.

Das Gerät darf keinen Tropfen oder Spritzern ausgesetzt werden und es dürfen keine mit Flüssigkeiten gefüllte Behälter, wie Vasen, auf das Gerät gestellt werden.

2.3 Allgemeine pflege

Wenden Sie bei der Handhabung von Schaltern und Anschlüssen keine Gewalt an.

Beim Umstellen des Geräts entfernen Sie zuerst die seriellen Anschlüsse, dann das Stromkabel und zum Schluss die Verbindungskabel zu anderen Geräten.

Versuchen Sie keinesfalls, das Gerät mit chemischen Lösungsmitteln oder Sprayreinigern zu reinigen, da dies das Gerät beschädigen könnte. Verwenden Sie ein sauberes, trockenes Tuch.

2.3 Aufstellung

Das Gerät sollte an einem kühlen, trockenen Ort aufgestellt werden, fern von übermäßiger Wärme, Vibrationen, Staub, Feuchtigkeit und Kälte.

2.5 Belüftung

Seitliche Schlitze und Öffnungen sorgen für die Belüftung des Geräts. Um die ordnungsgemäße Belüftung zu gewährleisten, dürfen diese Öffnungen nicht verdeckt werden. Sorgen Sie außerdem dafür, dass das Gerät an einem gut belüfteten Ort aufgestellt wird.

2.6 Gewerbliches eigentum

Einige integrierte Schaltkreise in diesem Produkt enthalten vertrauliche

Informationen und/oder Betriebsgeheimnisse. Sie dürfen daher diese Inhalte nicht kopieren, modifizieren, adaptieren, übersetzen, verteilen, rückentwickeln, rückassemblieren oder dekompileieren.

2 BELANGRIJKE VEILIGHEIDSINSTRUCTIES

Lees deze handleiding zorgvuldig door om het beste uit uw product te halen. Bewaar het op een veilige plek voor raadpleging in de toekomst.

Haal nooit het omhulsel van de eenheid af, dit om de kans op een elektrische schok te verminderen. Maak het apparaat nooit open: er bevinden zich geen door de gebruiker in te stellen onderdelen in het apparaat. Laat service en onderhoud over aan een gekwalificeerde technicus.

2.1 Elektriciteit en aansluiting

Dit toestel moet worden aangesloten op een netcontactdoos met een aardsluitingsbeveiliging.

Deze eenheid is niet van de wisselstroom voedingsbron gescheiden wanneer de stekker nog in het stopcontact zit. Wanneer de eenheid uitstaat, staat deze nog in de stand-by modus. In de stand-by modus vergt de eenheid minder stroom dan in de normale "aan" modus.

Wanneer u de eenheid voor langere tijd niet gebruikt, zorg er dan voor dat de stekker van het wisselstroomsnoer uit het stopcontact is getrokken.

Het wisselstroom stopcontact moet dichtbij de eenheid geïnstalleerd worden en makkelijk toegankelijk zijn.

Als de eenheid duidelijk beschadigd is moet u deze nooit op het lichtnet aansluiten of bedienen.

2.2 Water en vocht

Om het risico op brand en persoonlijk letsel te beperken is het gebruik van dit apparaat buiten en/of blootstelling aan regen, water of overdadige hoeveelheden vocht uitdrukkelijk verboden.

Het apparaat mag niet worden blootgesteld aan druppels of bespatting en er mogen geen objecten die gevuld zijn met vloeistoffen, zoals vazen, op het apparaat geplaatst worden.

2.3 Algemeen onderhoud

Forceer schakelaars of externe aansluitingen nooit.

Bij verplaatsing van de eenheid, de seriële poortaansluitingen eerst loskoppelen, dan de voedingskabel en als laatste de snoeren naar andere apparaten. Probeer de eenheid nooit met chemische oplosmiddelen of schoonmaakmiddelen in een spuitbus schoon te maken, omdat dit de eenheid kan beschadigen. Gebruik een schone droge doek.

2.4 Plaatsing

Deze eenheid moet geïnstalleerd worden op een koele droge plaats, uit de buurt van bronnen van extreme hitte, vibraties, stof, vocht en kou.

2.5 Ventilatie

De sleuven en openingen aan de zijkant van de eenheid zijn voor ventilatie. Zorg er voor dat de eenheid op een goed geventileerde plek geïnstalleerd wordt zodat deze betrouwbaar werkt.

2.6 Intellectueel eigendom

Sommige IC chips in dit product bevatten vertrouwelijke informatie en/of fabrieksgeheimen. U mag daarom de inhoud hiervan niet kopiëren, wijzigen, aanpassen, vertalen, verspreiden, nabouwen, of decompileren

3 CAPABILITY, DEVICE FEATURES AND PRODUCT FEATURES

3.1 Device Capabilities

The C2-3300 series uses the proprietary CORIO[®]2 Engine to perform its functions, being the second generation of the successful CORIO[®] products. The CORIO[®]2 technology is a powerful toolset for any application requiring high quality video signal conversion or image manipulation.

All units in the series feature a single video processing and scaling engine, with some units also featuring video mixing, keying, edge-blending, fader and audio capabilities.

These functions allow the flexibility for handling a wide range of inputs and outputs, all on universal HD15 ('VGA') connectors, with adapters for composite and YC (S-video) inputs.

All units are at one in the professional, broadcast and display environments. The C2-3300 series offers a range of high-level image processing functions – with each model designed to fulfill a particular need.

Each unit provides high quality up, down and cross conversion from standard video formats to Computer or HDTV signals. NTSC and PAL video standards are supported.

The output is selectable as any computer resolution up to 2048x2048 at any vertical refresh rate and all HDTV resolutions up to 1080p. A wide variety of computer signal formats are available to support PC, Mac and Workstation formats.

The **C2-3310 and C2-3360** have Differential Stereo Audio switching provided by an integral 8 x stereo audio routing switcher. The eight balanced inputs may be set to follow any of the video inputs. Connections are made via terminal blocks on the rear panel. Adjustment of audio volume and balance is possible (MUTE, -15dB to +15dB), plus separate routed outputs for program and preview.

The **C2-3350 and C2-3360** units have a wide variety of additional capabilities, including Genlock, Picture-In-Picture, Chromakey, Lumakey, Edge-blending and Mixing. The **Key Mode** allows any two video inputs to be keyed over each other. The keyed image may be faded in and out. Due to the 4:4:4 sampling format, precise keying at the pixel level can be achieved. The **Mix Mode** permits glitch-free mixing between the computer image and external video. The **PIP Mode** allows the computer inputs to be inset in a window over any other inputs.

The models available in this series are summarized as follows:

C2-3300

- Base unit, 8 input universal scaler, with program and preview outputs
- No PIP, genlock / mixing, keying, edge-blending or audio functions.

C2-3310

- 8 input universal scaler, with program and preview outputs
- 8 input differential stereo audio switching with program and preview outputs
- No PIP, genlock / mixing, keying, edge-blending or audio functions.

C2-3350

- 8 input universal scaler, with program and preview outputs
- Unrestricted single window PIP, genlock, edge-blending and mixing functions.
- No audio functions.

C2-3360

- 8 input universal scaler, with program and preview outputs
- Unrestricted single window PIP, genlock, edge-blending and mixing functions.
- 8 input differential stereo audio switching with program and preview outputs.

3.2 Device Features

Universal Inputs

Video Inputs are 8 x universal on HD15 female connectors for YUV and YPbPr Component, RGBHV, RGBS and RGSB with adapters allowing inputs of Composite Video and YC (S-Video).

General Topography

4:4:4 RGB / YUV sampling provides full bandwidth color which allows precise keying where included in the unit's capabilities. This can be achieved through the transparent (soft) keys on the front of the unit. Each unit's video inputs accommodate multiple video and computer signal formats and resolutions – see specifications at end of manual for full details.

Ultimate flexibility

The C2-3300 series' output signal format flexibility assures that the Native Resolution of virtually any display can be matched. Because of the resolution calculator (included in the Windows® Control Panel), even new resolutions can be added to the unit. Signal parameter adjustments can be made for each video input and are stored in individual non-volatile memories for retrieval once the unit's power has been removed. The Video Scaler units employ pixel adaptive motion compensation to de-interlace fast moving images, and automatic 3:2 Pull-down efficiently de-interlaces video from 24 fps NTSC film.

Simple Control

The unit can be controlled in various ways. One option is to control it from the front panel using the transparent (soft) keys on the front of the unit. Another option would be to control the unit from an infra-red remote control. It can also be controlled via RS-232 or via Ethernet using the Windows Control Panel.

The Windows Control Panel is available for download from our Internet site and affords complete control of the unit and adds Scripting to facilitate long, complex sequence of commands.

Finally, a hardware based switcher like the CORIO[®] console unit allows the user to control the unit by mimicking a classic video switcher device.

Upgradeability

The C2-3300 and C2-3310 may be upgraded remotely via firmware to the C2-3350 and C2-3360 units to provide the unrestricted single window PIP, genlock and mixing functions.

All C2-3300 units benefit from firmware upgradeability, thus reducing product obsolescence by allowing the installation of the latest version of firmware. This not only applies to the software used to control the unit, but also to the range of resolutions stored inside the unit, the addition of new features, and upgrades to the heart of the image processing hardware – the CORIO[®]2 scaling engine. See <http://www.tvone.com/support> for more detail.

4 PRODUCT IMAGES

Your C2-3300 product should look like one of the units below.

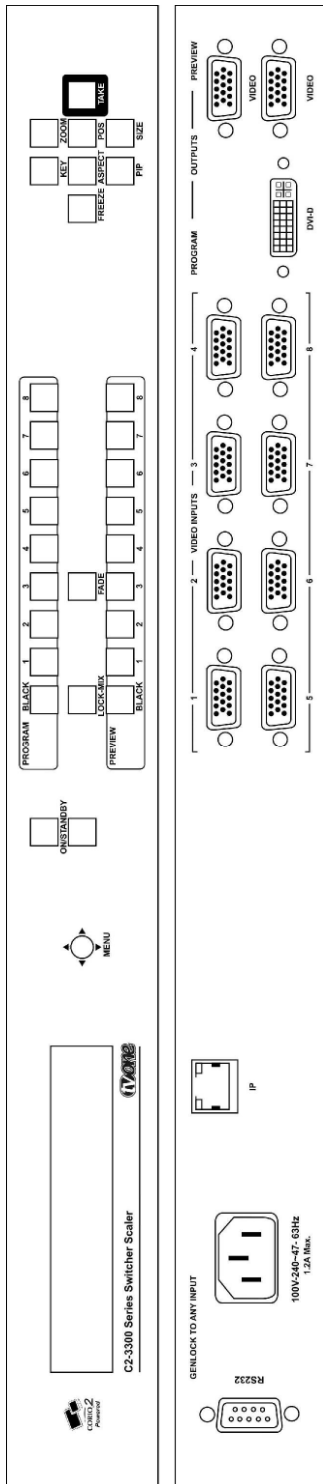

C2-3300 / C2-3350 (no audio)

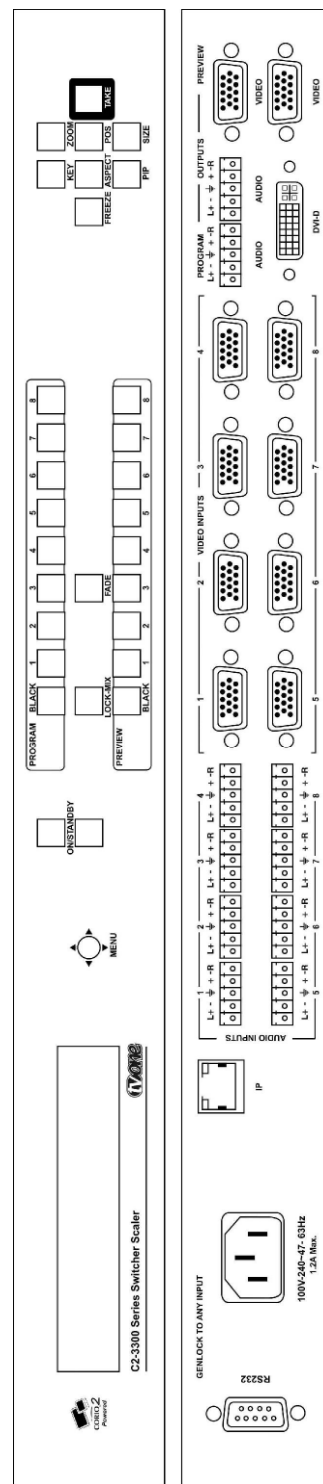

C2-3310 / C2-3360 (with audio option)

5 UNPACKING AND INSTALLATION

5.1 Furnished Accessories

Carefully unpack the carton and perform an inventory of the contents. In addition to the C2 series, the standard accessories include:

- 1 x Operations Manual
- 1 x AC Power lead
- 2 x Composite Video to HD15 Adapter
- 1 x YC Video to HD15 Adapter
- (8 x 5 way screw terminal blocks for audio option)

If any items are missing or defective, contact your supplier. If you are unable to resolve the problem with your supplier, contact TV One via the web at <http://www.tvone.com/support> for prompt replacement.

5.2 Important Safety Instructions

The AC power cable (Mains Lead) furnished with the unit will conform to the type in use at your geographic locale. Please compare the plug on your cable with the three types of power cable plugs currently being shipped to make certain you have received the correct power cable.

If you did not receive the correct cable, **DO NOT** attempt to modify the incorrect cable. Instead, immediately contact your dealer or contact TV One at the sales office nearest to your geographic location and request the proper cable.

US AC Cable Plug Example:

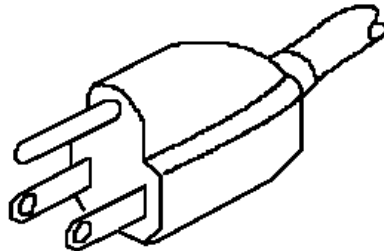

UK AC Mains Lead Plug Example:

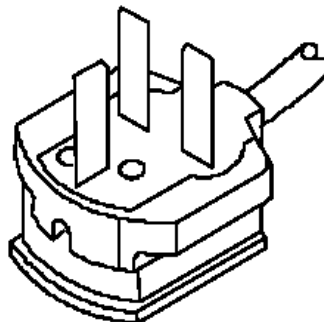

EU AC Mains Lead Plug Example:

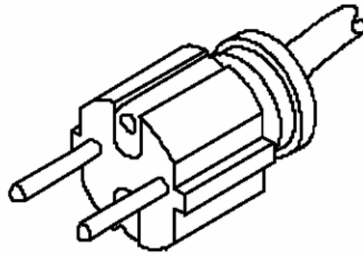

AGAIN, **DO NOT** ATTEMPT TO MODIFY AN INCORRECT AC CABLE (MAINS LEAD). REPLACE IT WITH A CORRECT PART PRIOR TO USING THE C2-7000 series.

Power is never totally removed from the unit when it's plugged into an active AC outlet. Pressing the button at the extreme right on the front panel only places the unit in a powered down mode. This button is a standby switch, not a true off and on switch. Never remove the unit from a cabinet unless the unit has been completely disconnected from AC power.

5.3 Factory Reset

To restore all operational parameters to their original condition, first ensure the unit is in the operational mode (not in Standby red power led illuminated). Press and hold the keypad 'joystick' in and press the standby switch. Unit will then be reset to default factory settings.

All stored settings except resolutions are lost when the unit is reset. A Firmware update is the only way to perform a complete factory reset.

5.4 Initial Video Operation Check

The C2-3300 series can be operated via the Front Panel Buttons, an LCD display and multi-directional switch, via a Windows based utility or via a dedicated CORIO® Console hat mimics the operation of a classic video switcher, or by use of the TV One Infrared remote control. For the purposes of initially acquainting you with the operation of the unit, this manual will address the operation using the Front Panel controls.

Connect the AC power cable to the unit. (Refer to the diagram below. The AC power cable connects to the socket labeled "Power 100v – 240v 47-63Hz" located on the left side of the rear panel as shown.)

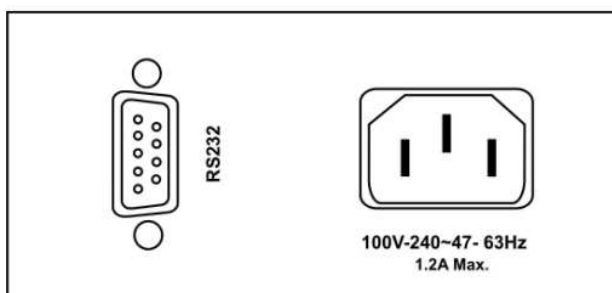

C2-3300 SERIES OPERATION MANUAL

We'll be using a Personal Computer for a signal source. Make certain that the monitor resolution can display 1024 x 768 @ 60Hz as this is the default output resolution for the C2-3300 series.

Disconnect the cable going from a Personal Computer's Monitor to the Personal Computer. Connect the output from the PC video card (the PC connector formerly used by the monitor cable) to the input labeled "VIDEO INPUT 1" on the rear panel of the Processor.

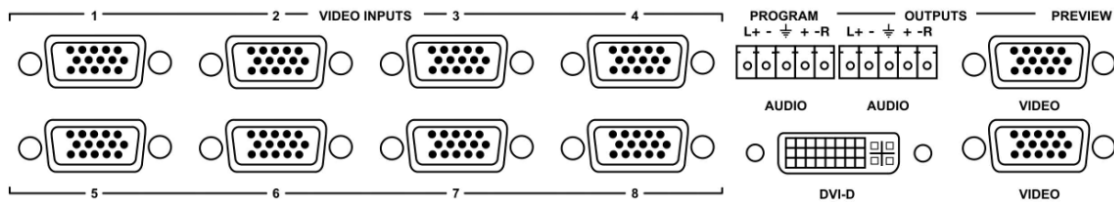

Next, take the cable from the PC monitor and connect it to the C2-3300 series' DVI-D / or VIDEO Program Output depending on the type of connection the monitor has. Then connect the AC Power Cable to a working AC outlet, turn on the PC, monitor and then the C2-3300 series.

Provided you have not changed anything from the Factory Defaults, the monitor will display output 1024x768@60Hz and the image from the PC on input 1. If this is the result, the C2-3300 series is passing and processing signals.

5.5 Initial Audio Operation Check

Following on from the video operation initial test, if the unit has the audio option, connect an audio source to audio Input 1, and an audio amplifier and speakers to the audio program out.

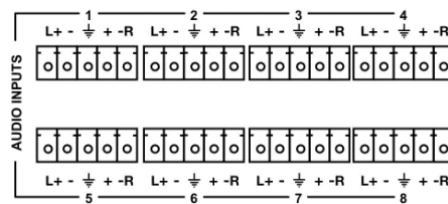

Again, provided you have not changed anything from the Factory Defaults, the audio signal from input 1 should be audible on the program audio output. If this is the result, the C2-3300 series is passing and processing signals.

The audio connections are balanced and care should be taken when wiring to unbalanced (single ended audio sources and drivers).

6 FRONT PANEL CONTROLS

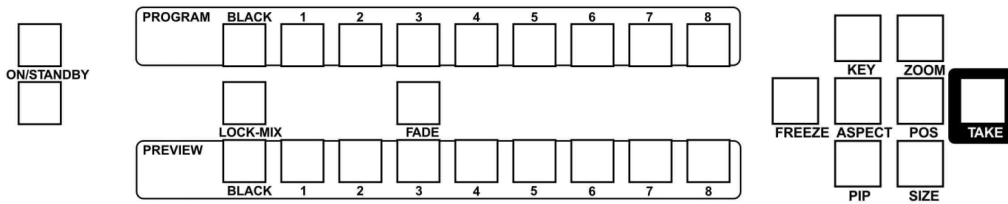

Front Panel Keyboard Close Up

The range of buttons on the front of the unit provides the user with quick access for selecting a variety of inputs and features. Since there are variations in the C2-3300 series, not all of the descriptions below will be applicable to the unit in question. The most notable is the LOCK/MIX/KEY/FADE buttons that are active on certain units only.

The multi-directional switch on the front panel provides the user with a way of navigating the Liquid Crystal Display menus (LCD) which is detailed in a later section. The RS232 interface and infra-red remote control also provide further ways of controlling the unit, which are detailed in a later section.

6.1 Button controls

A sub-set of the following buttons will be available on the front of the unit, depending on the model in use:

Button	Button Function
Multi-directional switch	Press and hold in to store current settings into memory. They will then be restored on power-on, or when a Restore is done. See next section for more information.
PROGRAM INPUTS	Selects a Universal input as the current source for the program output.
PROGRAM BLACK	Sets Program source to black screen.
PREVIEW INPUTS	Selects a Universal input as the current source for the preview output.
PREVIEW BLACK	Sets Program source to black screen once a Take has been done.
LOCK -MIX	Goes to the Adjust output menu for quickly changing the Lock mode. See 'Adjust outputs' menu details.
FADE	Fades out the current image – fades back in on next press.
KEY	Enables keying – see 'Adjust keyers' menu. (Key color defaults to black, so black foreground will disappear.)
ZOOM	Jumps to the 'Zoom' menu item.
FREEZE	Freezes the current image (does not affect any background image)
ASPECT	Toggles output 'Aspect Ratio'. See 'Adjust Windows' menu

	details.
POS	Jumps to the 'Adjust Windows H/V Position' menu item.
TAKE	Transitions selected Preview Input to selected Program Input.
PIP	Activate picture-in-picture mode. (Activates and deactivates the Shrink value in the 'Adjust windows' menu on the LCD Display)
SIZE	Jumps to the 'Adjust Windows Shrink Level' menu item.
STANDBY	Hold in to put the unit into Standby (power-save) mode. Hold in briefly to come out of Standby mode.

6.2 Multi-directional switch

The LCD is controlled from the front panel by using the multi-directional switch (m/d switch). This switch can be moved left, right, up or down and also pressed in. These functions let the user navigate through the menu structure or change a parameter, and are detailed in a later section.

6.3 Advanced menus

System Advanced menu	[Off]
-------------------------	-------

The above menu item must be 'On' to activate certain menu items. These typically control the more advanced items in the menus.

6.4 Special button combinations and functions

In addition to the ability to perform a factory reset and forcing certain output resolutions, other button combinations are available:



These button combinations only work when the unit is switched on and active i.e. with the STANDBY/ON LED is off. They will not work in Standby mode, or during power-up.

6.4.1 Locking front panel buttons & IR remote control

This can be performed by pressing STANDBY/ON and LOCK-MIX at the same time. All front panel buttons and IR remote control commands will be disabled, with the exception of repeating the above combination to un-lock the unit and for storing the current locked buttons setting (thus letting you make sure the unit always starts up with the buttons locked). The IR remote's LOCK and STORE buttons will always be active, giving another way to turn button/IR remote locking off.

The STANDBY/ON button will flash when the unit's buttons are locked.

6.4.2 Restore power-on settings

This can be done (without having to turn off the unit) by pressing STANDBY/ON and the multi-directional switch at the same time until a single beep is heard.

6.4.3 Factory Reset

If you wish to restore all operational parameters to their original condition (for example, if saved settings prevent the unit from working with your display monitor), hold the STANDBY/ON and the multi-directional switch in together until two beeps are heard.



All stored settings except resolutions are lost when the unit is reset. A Firmware update is the only way to perform a complete factory reset (including resolution data).

7 VIDEO INPUTS AND OUTPUTS

The C2-3300 series have a number of different video input and output options, which all connect through the universal HD15 connectors, apart from the dedicated DVI program output.

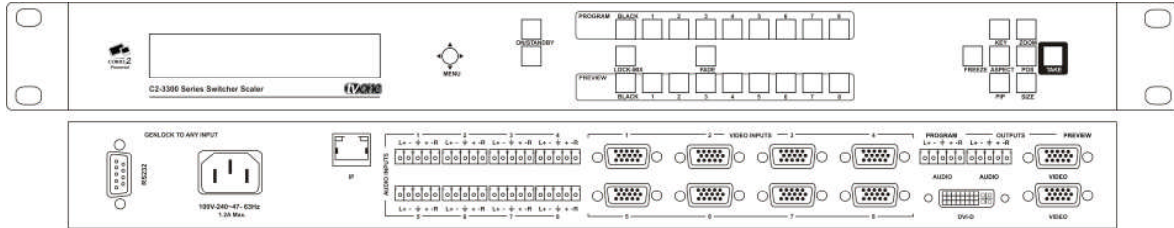

C2-3300 Series Front Panel and C2-3310 Rear Panel (with audio)

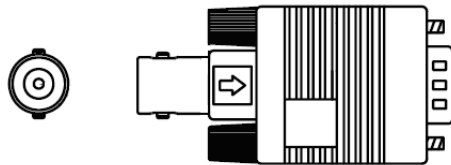

Composite Video Adapter

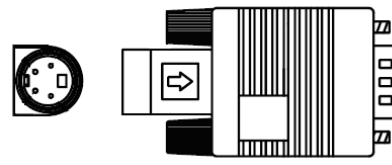

YC (S-Video) Adapter

7.1 Video inputs

The unit provides 8 universal inputs on HD15 connectors, which support:

- Composite - PAL/NTSC/SECAM
- Y/C - PAL/NTSC/SECAM
- YUV – 525i / 625i
- YPbPr - Up to 1080p 60Hz with Tri-Level Sync
- RGBHV, RGBS, RGsB - Up to 2048x2048

The following Television Standards are supported: NTSC 3.58, 4.43, PAL-B, G, I, D, H, PAL-M, PAL-N, SECAM.

In most cases, the particular input format being used will be auto-detected. See 'Adjust sources' for more information on manually selecting an input type.

YUV/YPbPr (component) inputs can also be switched to RGsB (sync on green) mode if desired – see 'Adjust sources' for more information on manually selecting an input type.

CV and YC inputs can accept either standard NTSC or PAL inputs – for example, from a video camera, VCR, DVD player, gaming device, etc. PAL and NTSC detection is automatic. Video adapters are required to convert the HD15 connectors to appropriate connector.

7.2 Video outputs

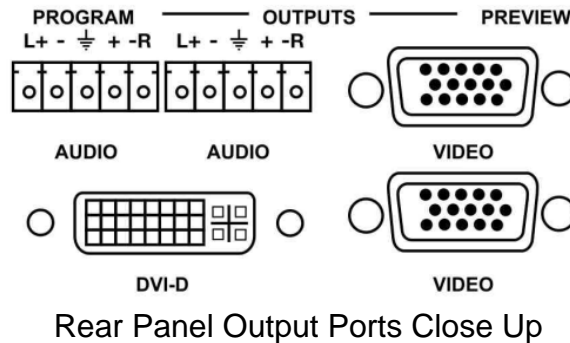

The Unit has two program video outputs; a DVI-D source (on a DVI-I connector) and an RGBHV source (on a HD15 connector). In addition a video preview is available on a HD15 connector.

The RGBHV program connector is universal and supports the following output types and resolutions:

- Composite - PAL/NTSC/SECAM
- Y/C - PAL/NTSC/SECAM
- YUV – 525i / 625i
- YPbPr - Up to 1080p 60Hz with Tri-Level Sync
- RGBHV, RGSB, RGSB - Up to 2048x2048

The unit supports the following Television Standards NTSC 3.58, 4.43, PAL-B, G, I, D, H, PAL-M, PAL-N, SECAM.

The DVI-D Connector does not support PAL and NTSC resolutions, and the output colour space follows that of the RGBHV connector in selection of RGB or YUV.

YUV/YPbPr (component) outputs can also be switched to RGSB (sync on green) mode if desired -see 'Adjust outputs' for more information.

CV and YC outputs always function simultaneously and can be set to either standard NTSC or PAL – see 'Adjust outputs' for more information. Note that RGB/YUV/YPbPr outputs can also be switched to function in this mode. Video adapters are required to convert the HD15 connectors to appropriate connector.

7.3 Audio inputs and outputs

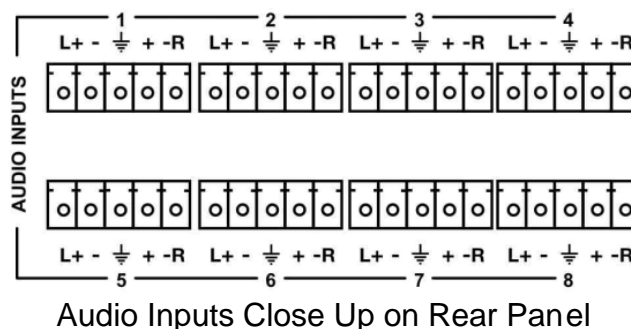

C2-3300 SERIES OPERATION MANUAL

The audio option provides eight balanced audio inputs via screw terminal connector blocks, and audio preview and program outputs. Connection details shown above. Each audio input may be associated with any of the video inputs, so that they may be switched together.

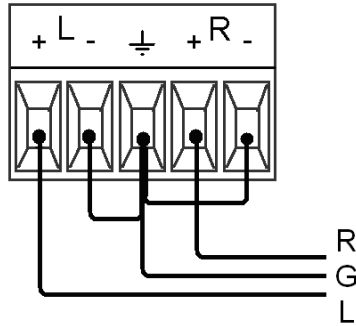

Unbalanced connections can be made by linking the L- and R- together, and if required also linking to GND, as shown here.

Each of the audio inputs through the 'Adjust Sources' menu, may have the volume modified (from -16 [mute] to +15 decibels) as well as its balance (from -15 [fully left] to +15 [fully right] with zero defining central position).

8 INFRA-RED REMOTE CONTROL

Your unit is compatible with an optional infra-red remote control as shown below:

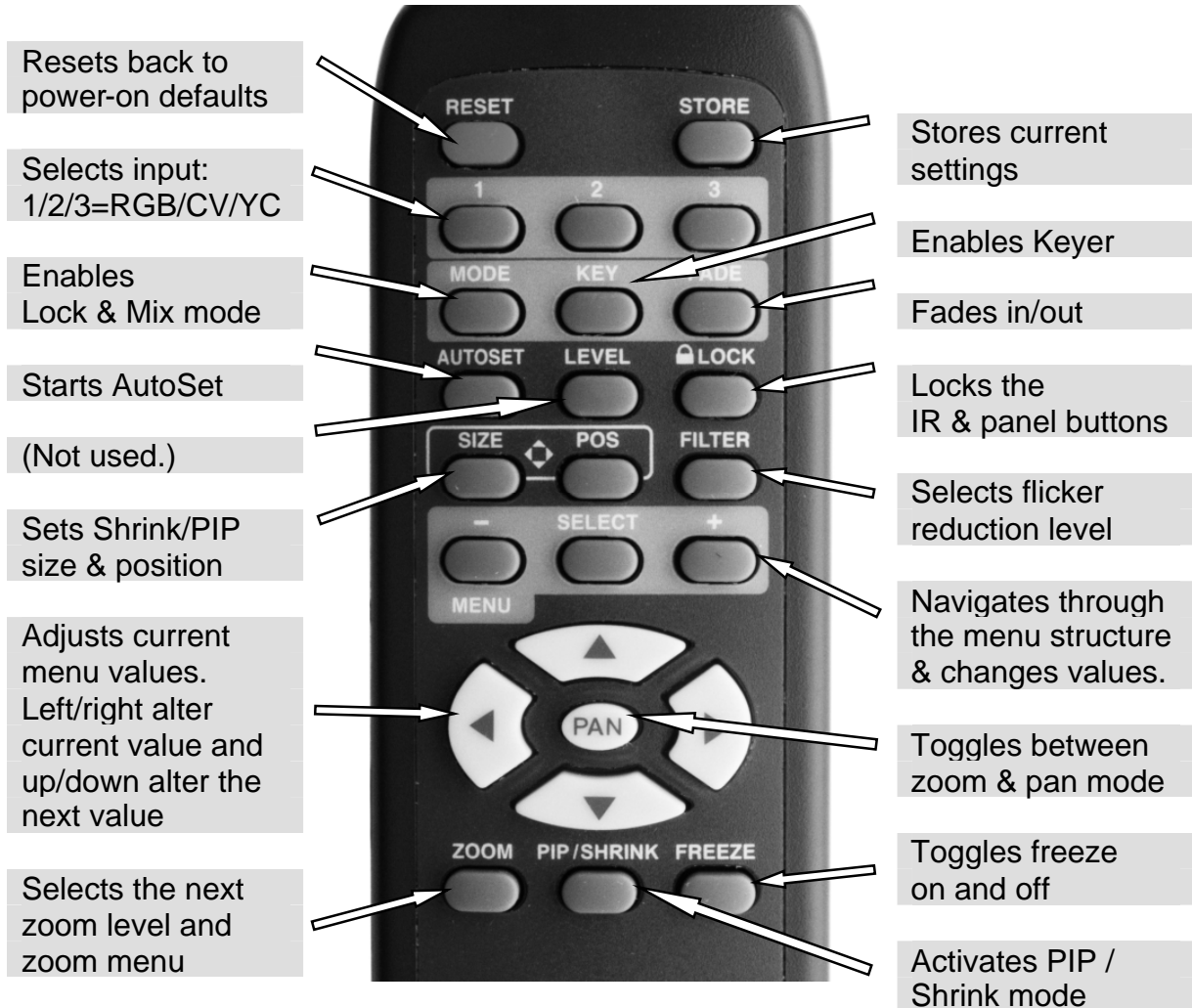

The transmit range of the remote control depends on many factors, but is designed to be fairly directional. Therefore you should always aim it directly towards your unit.

The IR remote control can be disabled in the System menu. This can be used in situations where multiple units respond to the same remote control or are located close to one another.

9 MENU LAYOUT AND SETTINGS ADJUSTMENT

From here on, we'll be looking at the menu structure employed in the C2-3300 series and, more importantly, the individual menu items that allow you to take advantage of the power of the unit.

You'll be using the multi-directional switch and the Liquid Crystal Display (LCD) to view the options and settings available to you. First press the multi-directional button in once to reveal the menu. Next move the multi-directional switch left or right to see where you are in the menu. Go into a sub menu by pressing the multi-directional switch once. To exit a sub-menu, scroll the multi-directional button to the end of the sub-menu to reveal Exit. Push in the multi-directional button to exit the sub menu.

You can edit a value in brackets '[]' by pressing the multi-directional switch once (you'll note that the brackets surrounding a particular parameter's value will begin to flash). Change the value by moving the switch left or right. Then finalise your adjustment by pressing the multi-directional switch once more.

A few menu items have multiple parameters within an individual menu selection. In those cases, you can adjust one item at a time. To do this, move to the next, parameter by moving the multi-directional button left or right

Adjust windows H/V zoom pan % [10] 20

Or, you can use the up/down positions of the multi-directional switch to alter the value following the one in brackets. Therefore, in the example above, where "[10] 20" is displayed in a menu item, the one in brackets is adjusted using the left and right positions, and the second number be can be altered using the up and down positions of the multi-directional switch.

Holding the multi-directional switch left, right, up or down for a short time will keep adjusting the relevant value, therefore allowing fast changes to a setting – which is very useful for positioning something on screen.



Pressing the multi-directional switch in for a few seconds stores all changes in memory. Unless you intentionally change it again later, the adjustment will remain even after power is removed from the unit.

9.1 The High Level Menu Structure

Menus are arranged so that a particular general function has a menu name on the top line and beneath that either a sub-menu or one or more related individual settings are displayed.

C2-3300 SERIES OPERATION MANUAL

In some cases the functionality is global – meaning it has an effect on the unit as a whole (such as changing the output resolution). In the majority of cases, the function is related to a specific operational area of the unit, detailed by the text in the top line.

There are two screens that appear before the Group Menus (sub-menus) are accessed.

CORIO2
TV One

The first is the 'welcome' display shown above indicating the model of the unit.

www.tvone.com
SW: 65. PT: 12, BT: 13

Moving to the next menu item displays the firmware information screen (the numbers on your unit will be different to those shown). The SW number refers to the version of firmware loaded into the unit, this can be upgraded from the support website.

The PT and BT numbers refer to Hardware version information and are of interest to the Technical Support Group should you ever need assistance.

At the end of all Group Menus will be an 'Exit' item. Simply select this to exit the existing menu structure and return to the previous one in the hierarchy.

9.2 Group Names and Descriptions

Menu Group Name	Group Description
Adjust outputs	Controls output parameters
Adjust windows	Controls characteristics of the pip windows
Adjust keyers*	Controls the keying ability of the unit
Adjust sources	Controls signal source input parameters
Adjust transitions	Controls transition mode for seamless switching
Adjust buttons	Controls buttons assignments.
Adjust ethernet	Controls IP addresses and network parameters
Adjust resolutions	Controls unit's input/output resolution table (hidden by default - only visible when advanced menus are switched on)
System	Controls global system parameters for the unit

*Note that not all units have this menu item

Note that the 'Advanced menus' menu item must be 'On' to activate certain menu items.

9.3 Items Associated with the Adjust outputs group

This menu group allows adjustments to be made that specifically affect the output of the unit, including output resolution and locking/overlaying onto a computer or video source.

800 x 600 60Hz Lock mode [Off] [RGB1]
--

This menu item allows the lock mode to be selected and the lock source to be defined. The top line of the display shows the current detected resolution of the selected lock source (RGB1 in this example). The lock mode can be either Off, Genlock or Lock & Mix, with the operation of these shown in the following table:

Lock mode	Description
Off	The output resolution of the Output is defined by the setting for Output Resolution and there will be no background source visible.
Genlock	The output video will be “Genlocked” to the selected lock source. The output signal will be synchronous to the input sync and adjustable but there will still be no lock source visible.
Lock & Mix	The output video will be locked to the selected source, the syncs will be locked (but with an additional internal video processing delay) and the background for the output will be that of the Lock source (unless foreground and background are swapped).
Frm.lock*	The frame rate of the output will be locked to the frame rate of the input. This can only work if the output resolution frame rate matches that of the lock source frame rate. ‘Frm.lock’ will flash until a highly stable lock has been achieved.

**Only certain models support this.*

In both Genlock and Lock & Mix modes the source selected for the lock input determines the resolution of the Output image. The output resolution for the entire image can be no different than the resolution of the lock source. All synchronization signals are re-generated within the unit so they may look slightly different when compared on an oscilloscope to the original source.

In Frame-lock mode, the output resolution is independent of the lock source, but the frame-rate must match that of the source (e.g. 1280x1024 60Hz can be frame-locked to 640x480 60Hz). Frame-lock is very useful for synchronizing a HD-SDI output (e.g. 1080i 59.94Hz) to a composite video source (e.g. NTSC), or for scaling one resolution to another while avoiding any potential frame-rate conversion artefacts.

'H/V shift' can be used to align the output to the input more accurately, but this may cause instability until the lock is re-acquired ('Frm.lock' will flash).



Before turning the Lock feature on, you first must select a valid Lock source. Some units may not have all Lock sources available, depending on hardware limitations – see Specifications for details of limitations on your unit.

If the Lock source you choose is not valid, then Genlock or Lock & Mix will be temporarily disabled, until the Lock source becomes valid again. When disabled, the resolution previously specified in 'Output res' becomes the output resolution.

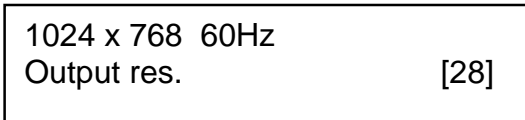

Your unit can handle a very wide array of inputs and convert them all to a single output signal with defined characteristics. This output resolution will remain in place until changed or it may be overridden by the lock mode and source.

The top line of the display will show the current output resolution selected. Some units will have a limited number of output resolutions depending on their function (e.g. Down Converters are more limited than Video Scalers).

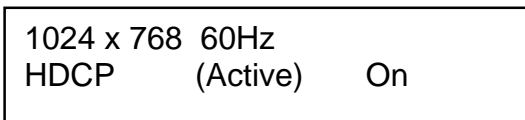

HDCP is handled only on certain units with DVI outputs, so this menu may not appear on your own unit. HDCP is a 'High-bandwidth Digital Content Protection' system, which can ensure that a high definition video signal cannot be received by units not equipped with a HDCP receiver.

This menu lets you see the current status of the output and whether HDCP is supported or active, and also lets you turn off the output's HDCP encryption system. Note, however, that turning HDCP off at the output will also prevent HDCP-encrypted signals from being received by the unit – see the table below.

By default, HDCP on the output is turned On - so that if your attached DVI display is HDCP-compliant, then your output will be encrypted (regardless of whether the input to the scaler is encrypted). Note that you don't have to attach a display to the output of the scaler – another unit can be connected instead, in which case that unit is known as a 'repeater'.

Please also see the HDCP menu item in 'Adjust sources', as this controls availability of HDCP at the DVI input. The status message given in brackets has the following meaning:

Status message	Description	Effect
Unavailable	The device attached is not	As the DVI output cannot be HDCP encrypted, then

C2-3300 SERIES OPERATION MANUAL

	capable of supporting HDCP.	a HDCP-encrypted source cannot be selected for scaling.
Supported	The device attached is capable of HDCP, but the output is not currently encrypted.	As the DVI output is not HDCP encrypted, then a HDCP-encrypted source cannot be selected for scaling.
Active	The device attached is capable of HDCP, and the output from the unit is encrypted.	As the DVI output is HDCP encrypted, then a HDCP-encrypted source can be selected for scaling. Note that no other output connector (SDI, CV, YC, YUV or RGBHV) will function – since they are not encrypted.
Rep. supprt	The repeater unit (e.g. scaler) attached is capable of HDCP, but the output is not currently encrypted.	As the DVI output is not HDCP encrypted, then a HDCP-encrypted source cannot be selected for scaling.
Rep. active	The repeater unit (e.g. scaler) attached is capable of HDCP, and the output from the unit is encrypted.	As the DVI output is HDCP encrypted, then a HDCP-encrypted source can be selected for scaling. Note that no other output connector (SDI, CV, YC, YUV or RGBHV) will function – since they are not encrypted.

Adjust outputs Output type [RGBHV]
Adjust outputs Anlog= [RGBHV] Dig= RGBHV

This menu may appear as either of the above – depending on whether the analog and digital outputs are controlled separately.

This menu item allows you to select the type of signal output your unit will provide. Types of output vary depending on the resolution selected and include various types of component signals YUV or tYUV (tri-level YUV) and the full range of RGB type signals RGBHV, RGBS and RGsB (Sync on green).

Note that this value is remembered for each resolution – so you can set 1024x768 60Hz to RGBHV and 1280x720 60Hz to tYUV and both will be remembered separately. This value is not affected by a Factory reset – but is reset by a firmware update.

Adjust outputs Optimize for SDI [On]
--

This menu item is only available on certain units with an SDI output and when locking to a CV or YC input. An internal de-jitter circuit ensures that the SDI output has a low jitter over the full 10Hz to 100kHz range, even though the CV or YC input may have a high jitter. However, this is not always compatible with a CV/YC output where the colour sub-carrier should not be de-jittered and needs to follow a Lock source's input – hence it should be turned Off if the CV/YC outputs are going to be used.

Adjust outputs
Stand. [NTSC-M/PAL-BDGHl]

This menu item is only available when the Output resolution is set to PAL or NTSC. With this you can change the output type to the PAL or NTSC standard with the further option of changing the output to the additional PAL & NSTC standards such as PAL-M or PAL-N. SECAM is also available as an output on some units, provided the 'Output res' is set to PAL / 50Hz.

Adjust outputs
Luma/chr BW [Med] / [Med]

This menu item is only available on certain units when the Output resolution is set to PAL or NTSC. With this you can change the output filtering system to increase or decrease the image sharpness. In general, high sharpness can result in increased colour disturbance.

Adjust outputs
Back Y/U/V [16] [128] [128]

Sets the value of the fixed background color, which is present when PIP is used with no Lock source background displayed. This menu item is only available for units with overlay, keying and fading abilities.

9.4 Items Associated with the Adjust windows group

This menu group allows adjustment to be made to window specific parameters such as the window source, its position, size and zoom level.

Info:

Window size adjustment can be performed in a number of different ways according to whether 'Aspect adjust' is set to Simple, Advanced or Pixel. The main part of this text assumes Simple mode – see later for a detailed description of the other modes.

Adjust windows
Window to adjust [A]

This menu item only appears on units with multiple windows or PIPs. It is used to select which one you want to modify. Alternatively, use one of the dedicated buttons on the front panel to choose the window to adjust.

NTSC / 60Hz
Source [YC1]

The source display screen allows the input source for the currently selected window to be changed. The top line of the display shows the detected characteristics of the signal. Valid Input sources match those available on the front of the unit.

Info:

Certain units do not have full flexibility of Window source and Lock source when Genlock or Lock & Mix are active (in the Adjust outputs menu group). See the Specifications for your unit to see if any limitations are present.

Adjust windows
Window enable [On]

Available on certain units only, this quickly enables or disables the window being adjusted.

Adjust windows
Zoom level % [100]

Changing this option, sets the amount of picture magnification you wish to use for the window Source. You are provided with the options to zoom the image from 100% to 1000% (10x zoom).

Adjust windows
H/V zoom pan % [50] [50]

Once an image has been 'zoomed', this control allows the image to be positioned within the window so that any portion can be seen, not just the middle.

Adjust windows
Image freeze [Off]

This menu item allows the image to be frozen or unfrozen – thus keeping a single image on screen indefinitely. Note that images are not stored when power is removed from the unit.

Adjust windows
H/V crop % [0] 0

This allows the scaled image to be cropped at the top/bottom edges, or at the sides. Typically, this is used when performing a picture-in-picture (PIP) function (only available on certain models), where the incoming video signal has a letterbox or pillarbox size (i.e. it has black areas at the top/bottom or sides).

By adjusting the H/V values, you can crop out the black areas to correct the size on the final output screen. Note that it does not change the shape or aspect ratio of the image – but just removes the parts of the image that are not required.

Adjust windows
H/V out shift [0] [0]

This positions the selected Window horizontally and vertically on the monitor. This should only be used for 'fine tuning' and should not normally require adjustment – use the Shrink H/V adjustment when your image is less than 100% Shrink value.

Adjust windows Shrink level%	[50] [On]
---------------------------------	------------

Shrink Level determines the percentage of the monitor's total available screen space that the selected Window image occupies. Adjustment is provided for a reduction down to 10% of the overall output size. In most cases, this feature is used for picture-in-picture (PIP) when a background image is being used (for units with overlay abilities).

Note that some units do not have the [On] entry – this is only for units with a PIP button on the front, with turns this entry On and Off. On these units, this feature is 'Off' by default, so that the full image size of 100% is used. Shrink level will need to be turned On before any change to this value has an effect.

Adjust windows H/V position %	[100] [50]
----------------------------------	-------------

This menu option determines the position of the shrunken image on the monitor screen. This will move an image that is less than the full screen size left/right or up/down within the monitor's available screen space. It will not let you move the image off the screen, so certain values will appear to have no effect (unless you use a very low Shrink value like 10%).

Adjust windows Aspect change	[Normal]
---------------------------------	----------

This item provides a simple way of changing the output screen aspect ratio, to suit the incoming video signal and final output display size. Use the zoom/shrink functions for occasions when the aspect ratio is an odd format.

Adjust windows Aspect adjust	[Simple]
---------------------------------	----------

See later section for further details on this item.

Adjust windows Temporal interp.	[Off]
------------------------------------	-------

This is a feature only present in advanced units only. It greatly improves the method of frame-rate conversion, by allowing the unit to merge frames together during the process.

When 'Off', the unit will use frame-repetition when converting 50Hz to 60Hz (i.e. it has to duplicate every 5th frame), or frame-dropping when converting 60Hz to 50Hz (i.e. it has to drop every 6th frame). When 'On', smooth blending is applied so that frames are not lost, but blended together at the appropriate times.

Adjust windows Flicker Reduction	[Low]
-------------------------------------	-------

The Flicker Reduction menu item will only appear if you have selected a low resolution interlaced output such as PAL or NTSC. If you are using CV or YC outputs, this adjustment may be of interest, particularly when you have line drawings or similar fine detail. You can choose from four possible Flicker Reduction settings. You should use as little Flicker Reduction as possible because the Vertical detail will be softened at the highest setting.

Flicker mode	Function
Off	Disables flicker reduction (sharpest mode).
Low	Suitable for most input sources.
Med.	Enough for most situations such as thin line drawings
High	Highest amount of flicker reduction. Will cause loss of vertical detail in some images.

Adjust windows Image smoothing	[Auto]
-----------------------------------	--------

Image smoothing reduces the jagged-edges sometimes seen within an output image by softening it. It typically improves the quality of a scaled image greatly. There are four possible settings for this adjustment: “Off”, “Med.”, “High”, and “Auto”. The “Auto” setting is generally thought to be most desirable and will vary the smoothing process according to the amount of zoom taking place.

Adjust windows Image flip	[Off]
------------------------------	-------

Occasionally, it’s necessary to cause the output image to be flipped Vertically, Horizontally or both – most commonly when a video projector is ceiling-mounted, or for special effects.

Adjust windows Max fade level %	[100]
------------------------------------	-------

This Menu item fades the selected layer, and is only available on models with overlay abilities. Adjustment range is from solid to fully transparent.

Note: This menu item only appears on multi-channel scalers:

Adjust Windows Layer priority abABZ	[3]
--	-------

This adjustment selects the order of the window layers. Layers are shown for ‘a’ and ‘b’ logo screens, Window ‘A’, Window ‘B’ and ‘Z’ is the Lock Source. The default condition is shown. The number shown is the current layer of the active window, when you adjust the layer number the layer stack indicator ‘abABZ’ will change to allow visualization of the layer stack. Note that layer 6 the Background

Color is not shown as its layer position can not be altered – it will always be the background.

9.4.1 Extended scaling controls

The ‘Aspect adjust’ parameter is used to change the way that scaling of windows is controlled. By default it is set to ‘Simple’ which allows basic control of the window zoom and shrink sizes and positions – enough for simple tasks.

In ‘Advanced’ mode, it allows the horizontal (H) and vertical (V) components of the Zoom and Shrink functions to be adjusted independently, thus allowing custom aspect ratios to be created, or to convert from one aspect ratio to another.

In ‘Pixel’ mode, the user has direct access to pixel and line-accurate scaling functions. This lets the user specify the exact co-ordinates and size of the source image (within the video source), and the position and size of where this is placed in the output video signal.

The table below summarises the different menu items in the different modes – the ‘Simple’ items have already been described earlier in this section, so only the ‘Advanced’ and ‘Pixel’ ones that are different (highlighted in bold) will be detailed here.

Simple	Advanced	Pixel
Zoom level % [100]	Zoom H/V [100]100 1.333:1	In [0],0 640,480
H/V zoom pan% [50] 50	H/V zoom pan% [50] 50	Out [0],0 640,480
H/V crop % [0] 0	H/V crop % [0] 0	
Shrink level % [50] Off	ShrnkH/V [50] 50 1.333:1	
H/V position % [50] 50	H/V position % [50] 50	

9.4.2 ‘Aspect adjust’ = ‘Advanced’

Adjust windows
H/V zoom % [100] [100]1.333:1

This item allows the independent setting of the horizontal and vertical zoom values. The third number (1.333 in the example) is the Aspect Ratio resulting from the adjustments, which is automatically calculated for you based on the incoming resolution and the H & V Zoom values.

Most resolutions are 4:3 ratio, thus the third number will be 1.333 (4 divided by 3). Another common aspect ratio is 16:9 (16 divided by 9 = 1.777). PAL and NTSC inputs are physically 4:3 on your video monitor, but their actual pixel/line ratios are different and so will not display as 1.333.

Adjust windows
Shrink H/V % [100] [100] 1.333

This item allows the setting of different Horizontal and Vertical 'shrink' sizes. The third number (1.333 in the example) is the Aspect Ratio resulting from the adjustments, which is automatically calculated for you based on the output resolution (the actual pixels & lines, not your physical screen size) and the H & V Shrink values.

Most resolutions are 4:3 ratio, thus the third number will be 1.333 (4 divided by 3). Another common aspect ratio is 16:9 (16 divided by 9 = 1.777). Therefore, to convert your 4:3 output into a 16:9 output, reduce the vertical (V) Shrink value to 75% and this will simulate a 16:9 output. PAL and NTSC inputs are physically 4:3 on your video monitor, but their actual pixel/line ratios are different and so will not display as 1.333.

9.4.3 'Aspect adjust' = 'Pixel'

Adjust windows	In	[300],	150	750,	400
Adjust windows	Out	[50],	50	250,	300

These menu items work together to specify the exact co-ordinates and size of the source image (within the video source) and the position and size of where this is placed in the output video signal – in other words the 'In' and 'Out' positions and sizes.

The diagram below should help to clarify the function of these values:

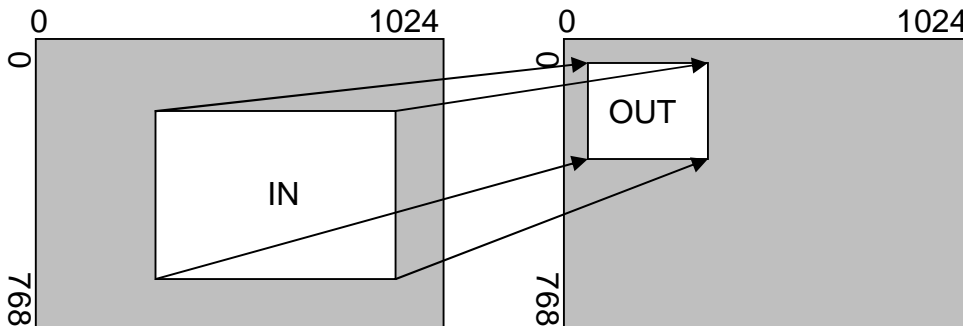

In the example above, 'In' has been set to 300,150 as its top-left source co-ordinate, with a size of 750,400. 'Out' has been set to 50,50 (i.e. close to the top left) with a size of 250,300.

The scaler will then ensure that the whole of the source (of size 750 by 400) is scaled to the required output (of size 250 x 300).

9.5 Items Associated with the Adjust keyers group

Please note that not all units have this sub-menu – it is only present on units with overlaying abilities.

Towards the end of this manual you will find a section titled ‘COMMON OPERATIONS’ – this gives a step-by-step guide to keying out a particular color.

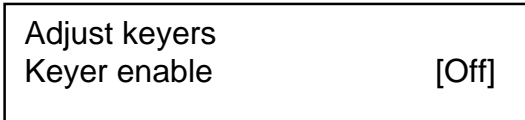

This menu item turns keying On or Off for the current foreground. A keyed image is in essence one image superimposed over another – such that portions of the top image are made transparent (keyed out), so that the background image can show through. The following settings allow you to vary the colour(s) that are keyed out.

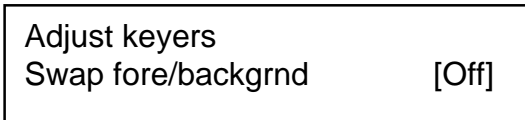

This menu item is only present on single-channel scalars – dual-channel scalars have the layer priority set within the ‘Adjust Windows’ menu.

This menu item allows you to swap the foreground and background images when Lock mode is set to Lock & Mix. It will have no effect in any other mode (since no background is present).

Normally, your foreground is the input (window) source and your background is the lock source. This then allows you to superimpose any graphics or video input on top of the lock source by keying out a certain color or range of colors in the input source. Swapping them means that the input source moves to the background and the lock source is now in front of it. Thus you are now keying out the lock source colors to reveal the input source behind it.

Note that this is different to simply swapping over the input and lock sources as that would affect the final output resolution – see examples below:

Input source	Lock source	Swap	Foreground (keyed)	Background (non-keyed)	Output resolution
XGA	NTSC	Off	XGA	NTSC	NTSC
XGA	NTSC	On	NTSC	XGA	NTSC
NTSC	XGA	Off	NTSC	XGA	XGA
NTSC	XGA	On	XGA	NTSC	XGA

(XGA is 1024x768)

You will see that the Swap between foreground and background has no effect on the output resolution as this is always set by the Lock source.

Adjust keyers	
Y Key min/max	[0] [32]

The Min/Max parameters are used to select what range of Y (luminance/grey-scale) values are made transparent within the selected window/lock source. In order to key out part of an image, start with the max value and increase it until the required lighter parts within the window/lock source disappear. Then adjust the min level to bring back any darker parts of the image.

Adjust keyers	
Y Key softness	[0]

The Y Key softness option removes noise from the keyed image, generally at the edges. Adjust as required to make the edges of the key as sharp or as soft as desired. The noise is where the analog to digital process (A/D conversion) may not sample a 50% brightness as being exactly 50% i.e. sometimes 49% and sometimes 51%. Increasing the softness value will broaden the range of keyed colors so that the keying of images varies depending on how close a color is to the keyed-out range.

Adjust keyers	
Y Key invert	[Off]

The Y Key invert changes the keying characteristics with respect to what colors of the foreground image you wish to 'key out'.

Setting it to Off will cause the colour range that's defined to be removed - remove the desired colors. Setting it to On will cause the colour range that's defined to be kept - key out all other colors.

The descriptions above behave identically on the remaining U Key Invert & V Key Invert component versions. However they are directed at the U/B-Y (blue) colour component and V/R-Y (red) colour components respectively. Adjustment and effects are the same as explained above for Y Key Invert (brightness/grey-scale).

9.6 Edge Blend items within the Adjust keyers group

Please also see the section titled 'EDGE BLENDING SETUP' later in this manual.

Adjust keyers	
Edge blend	[None]

This menu item controls which of the 4 edges are blending into the background. In general, only the left or right are blending, but the unit allows you to control the edge blending for any number of edges.

If any edges are set (e.g. [L] for left) then Keying is no longer available and extra menu items will appear as follows:

Adjust keyers E.blnd guides [Off]

This menu item allows you change whether the red and green edge blending guides will appear. You can have them permanently Off, permanently On, or set to Auto (where they will only appear when you are in the Adjust keyers menu).

Adjust keyers E.blnd size [50] x [50]
--

This controls the blend width and height respectively. Left and Right blend sizes are adjusted together by the first number, and Top and Bottom blend sizes are adjusted together by the second number.

Adjust keyers E.blnd gam. [1.00] x [1.00]
--

This controls the gamma for the blend width and height respectively. Left and Right blend gamma values are adjusted together by the first number, and Top and Bottom blend gamma values are adjusted together by the second number.

The gamma values affect the linearity of the blended edges, allowing for the fact that projectors do not normally output a picture whose brightness is directly proportional to the voltage within the video signal. These values are best adjusted once any overlapping images are aligned with each other

Adjust keyers Eb comp cent/side [0] [0]
--

This controls a 'compensation' value that sets the minimum brightness of the centre and side areas during edge-blending. It is used to compensate for the fact that projectors cannot generally output a purely black signal – and hence the overlap area would normally be brighter as a result. Increasing the centre area's value will compensate for this.

For 2x2 (or higher) setups, the side value can also be adjusted to correct for corner brightness errors

9.7 Items Associated with the Adjust sources group

The 'Adjust Sources' menu group accesses the parameters associated with the processing amplifiers used for each input (RGB, CV, YC, etc.). They allow you to fine-tune an incoming signal to optimize its color, brightness or even sharpness.

Info:

Not all settings are available for all input types, and not all input types listed here may be available on your unit. Also note that many of these adjustments may not show without 'Advanced menus' set to On.

It is recommended that you Store your settings once you're happy with them in readiness for future use.

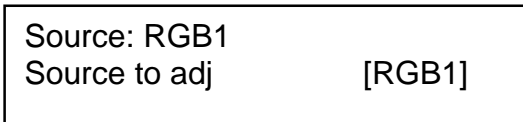

This menu item selects the input connection for which you want to make adjustments to. As in the image above, changes will only be made to the source connected to RGB1. Once the selection has been made, all changes made using the following operating parameters will only apply to the selected input.

Info:

Selection of a CV/YC source will reveal different menu items that allow adjustments beyond those used for RGB sources. The menu discussions that follow relate first to RGB sources, then to CV / YC type sources.

9.7.1 Menu items common to all inputs

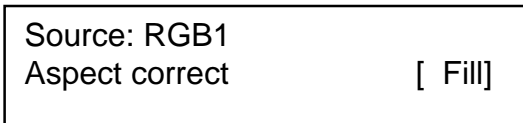

This menu item will be used to correct the aspect ratio of the video source when converted into the final output resolution. The following table details what happens in the available modes:

Setting	Result
Fill (default)	The source is stretched to fill the output.
Aspect	The source's aspect ratio is maintained on the output.
H-fit	The source is stretched to fill the horizontal dimension of the output, with the vertical dimension stretched by the same amount (and possibly clipped).
V-fit	The source is stretched to fill the vertical dimension of the output, with the horizontal dimension stretched by the same amount (and possibly clipped).
1:1	Each source pixel is represented by a single output pixel – no scaling will be performed. If the input resolution is higher than the output, then only part of the source will be seen. If the input resolution is lower than the output, then a black border will be present.

Source: RGB1 TL pos. adj. [0] [0]
--

This menu item allows manual positioning of the Top and Left portion of the image. It is used to ensure that the input signal is captured correctly, eliminating any black borders. These settings are often used to correct the position of a PC signal on an input, or to eliminate any undesired noise at the top or bottom of a PAL or NTSC video source.

Source: RGB1 BR size adj. [0] [0]
--

This menu item allows manual positioning of the Bottom and Right portion of the image. These settings are often used to correct the position of a PC signal on an input, or to eliminate any undesired noise at the top or bottom of a PAL or NTSC video source.

Source: RGB1 Audio input source [1]

If your unit has an internal audio switcher / selector, this menu item selects the desired Audio input for use with the active video source, allowing an audio-follow-video function.

Source: RGB1 OPTION audio source [1]
--

If an external audio switcher is connected via the OPTION bus, then this menu item selects the desired Audio input for use with the active video source, allowing an audio-follow-video function.

In most situations, the Audio input values would be different for each video source – so that when the first video source is selected, so is the first audio source (this is called ‘audio follow video’). The second video source then selects the second audio source, etc. However, there is nothing to prevent all Audio input values being set to the same value, for ‘audio breakaway’.

Source: RGB1 Audio Vol [1] Bal [0]

This menu item adjusts the audio volume and balance for the selected audio channel. This is only functional for certain units when an optional Audio Switcher is attached.

Source: RGB1 On source loss [Blue]

(This has replaced ‘De-glitch’ used on previous firmware versions.)

C2-3300 SERIES OPERATION MANUAL

This option is used to tell the unit what to do if the video source is lost or becomes unstable. Options are:

Option	Description
Show	Shows all picture break-up and instabilities.
Freeze	Freezes the latest frame – un-freezes as soon as the source becomes stable again.
Blue (default)	Turns the window blue, to represent source loss.
Black	Turns the window black.
Remove	Removes the window, thus showing any background (e.g. a Lock source). This is useful for MIX & PIP scenarios on units with overlay abilities.

If you have a very unstable input, such as a video tape player with a poor (jumping) output signal, you may wish to turn the setting to 'Show'.

Source : RGB1	
De-int	[M.comp med]

An interlaced input consists of two fields separated in time. Both fields are required in order to make up the full resolution input image, but since they are sent one after the other, a moving image will have "motion artifacts" if the two fields are simply combined together. The most common artifact is a blurring at the point of maximum movement within an image. Your unit provides some tools to minimize the effects of de-interlacing of an image.

The following options are available for this menu item:

Mode	Function
Normal/weave	The two interlaced fields are simply combined/weaved together. This will often show artifacts on moving images, but can be used when the input is known to be still.
Auto	Automatically selects Film 3:2 or Medium Range Motion Compensation (M. Comp Med.) depending on whether Film Mode is detected or not.
Film 3:2	Enables 3:2 pull down conversion of the incoming NTSC video. (This option should not be used if the source is not NTSC video).
M. Comp Low M. Comp Med. M. Comp High	Enables Pixel Adaptive Motion Compensation. Three levels are available with 'Low' providing the least compensation for Motion and 'High' providing the most compensation.
Frame/bob	The two fields are shown consecutively.

Source : RGB1	
Diagonal interp.	[Off]

This menu item allows the user to specify whether the source has diagonal interpolation applied to it when de-interlacing occurs. This reduces 'jagged' artifacts

on moving images, however is not suitable for noisy sources where the noise could be mis-interpreted as a diagonal or sloping element of the picture.

Source : RGB1 Noise reduction [Off]
--

This menu item allows the user to specify whether the source has noise reduction applied to it. This is performed by averaging the video signal over a number of fields – but ignoring areas where motion has occurred. If motion blurring is seen, it is recommended to turn this setting off.

9.7.2 DVI Source Menu Items

Source: DVI1 HDCP [Inactive] [Off]

HDCP is supported on certain units only - and only on the DVI input connector. This menu item lets you change whether HDCP is active on this particular DVI input.

If turned 'Off', then a source that requires HDCP encryption will not send a video signal to your unit.

If turned 'On', and a HDCP-compliant display or device is attached to your unit's DVI output, then HDCP encrypted sources can be used.

The following table summarizes the message given in brackets:

Status message	Description	Effect
Inactive	HDCP is not active at the DVI connector.	HDCP-encrypted material cannot be received by the unit.
Active	HDCP is active at the DVI connector.	HDCP-encrypted material can be received by the unit, but only if a HDCP-compliant display or device is attached to the unit's output.

See 'Adjust outputs' for a description of how the HDCP system works on your scaler.

Source: DVI1 EDID to use [Def]

This feature is only present on certain units – it is used with the next menu item to form a simple 'EDID Manager'.

C2-3300 SERIES OPERATION MANUAL

EDID is an information packet retrieved by a PC graphic card over a DVI link from a monitor which tells the graphic card which resolutions are compatible with the monitor. In the case of the your unit, it tells the graphic card what resolutions are compatible with it.

The above menu lets the user select which of 8 EDID data blocks are 'shown' to a PC or other DVI source. (It does not affect any other input.) Note that graphic cards will usually only read the EDID data when the cable is first connected, or on power-up.

The 8 EDID blocks are as follows:

EDID	Usage
1	User-definable – see 'EDID capture'
2	
3	
4	
5	
6	
Def	Default EDID data for your unit
Mon	The attached DVI monitor's EDID data

If you change this value, you'll need to store your settings and then re-boot the CORIO2 unit at least once to ensure that the DVI source sees that the EDID data has changed.

It should also be noted that some graphic cards will require your PC to be re-booted before they see that a change has occurred.

Source: DVI1 EDID capture [1] Grab
--

This menu provides a simple way of capturing EDID data from an attached DVI monitor and storing it in one of the user-definable EDID memory data blocks (1 to 6) – see previous menu.

To capture a different display's EDID, perform the following:

1. Connect that display to the DVI output of the CORIO2 unit - the CORIO2 unit will then read it automatically and store it in the 'Mon' EDID entry.
2. Select which EDID memory (1 to 6) to copy this information to.
3. Select 'Grab' and click on it - this will copy the current monitor's information to that EDID memory.
4. Change 'EDID to use' to that memory location (1 to 6).
5. Store your unit's settings (see earlier in this manual on how to do this).

6. Re-boot (turn off and on again) the CORIO2 unit to ensure that the graphic card uses this new EDID data (you may need to re-boot your computer as well).

Using the above, up to 6 custom EDID settings can be stored in the CORIO2 unit, ready for recall later. This is useful to simulate another display being attached to a graphic card.

9.7.3 RGB Source Menu Items

Source: RGB1 Autoset status	[Inactive]
--------------------------------	------------

Once the Autoset sense setting has been made, this menu item is accessed and activated. The Autoset sense utility will then correct the pixel phase and then position the Top Left portion of the image and the Bottom Right portion of the image. Once complete it then resume inactive status.

Source: RGB1 Input pixel phase	[16]
-----------------------------------	-------

Since an image pixel is a very small element of the total image, it's possible for your unit's Analog to Digital converters to wrongly sample the picture on the edge of each pixel thereby losing image resolution and creating image noise. The Input pixel phase adjustment allows you to change the position (from 0 to 31) where the pixels are sampled, relative to the horizontal sync signal.

To make this adjustment, select an RGB source and then provide an image from that source with fine detail, preferably with very sharp vertical lines. Adjust this value until you see the sharpest image. Alternately, adjust this value to give the worst (noisiest/softest) image, and then add or subtract 16 to get the optimum value.

Note that the AUTASET function (for RGB inputs only) will attempt to automatically work out the best value for this setting.

Source: RGB1 RGB input type	[RGBHV]
--------------------------------	---------

There are several types of signals that are called RGB signals as a generic term. Each has slightly different characteristics that set it apart from similar RGB signals – such as how the synchronization signal is sent. This menu item lets you set the input type to use.

Available options let you select whether the input is standard RGB or YUV (including YPbPr signals with a tri-level sync).

Source: RGB1 RGB contr. [100] [100] [100]

This menu item lets you adjust the individual RGB or YUV/YPbPr signals, in case one component is at a different contrast to other, or if they all need to be boosted or lowered.

9.7.4 CV & YC Source Menu Items

Of the above Source Menu items, the Autoset sense and Autoset status functions, RGB type and Pixel phase are specific to RGB signals only. The rest of the Source menu items function with RGB, CV or YC type signals. In addition, there are four additional Menu items that are only used with CV or YC type signals and these are explained below:

Source: YC1 Bright [100] Contrast [100]

Adjust the Brightness and Contrast of the image to your requirement.

Source: YC1 Satur [100] Hue [0]

Saturation is the amount of color present in the image. Hue is the color “tint” parameter and the adjustment range is +90 degrees through to -90 degrees with 0 being the default.

Source: YC1 Sharpness [0]

Within limits, you can enhance or soften the appearance of detail within an image. The Sharpness values go both negative and positive, with 0 being the default. Note that over-enhancing an image has the side effect of making it appear to be noisy and under-enhancing an image gives the appearance of poor video quality.

Source: YC1 Luma delay [0]

On occasion, a video source will have the color portion of the signal offset from the luminance portion. If you’ve ever seen a poor quality comic book that has the outline of the cartoon character’s head in one place on the page but the flesh tones for the head offset slightly, you are seeing the print equivalent of Luminance to Chrominance Phase Delay.

Fortunately, your unit provides a way for you to make the two signals occur at the same time on the selected image. The adjustment range provides both positive and negative levels of delay with 0 being the default.

9.7.5 Still Image Store / Testcard Source Menu Items

Source : TC1 Testcard	[0]
--------------------------	-------

This item is only available for units supporting Still Image Stores (SIS) or Testcards (TC) – which are the same thing, but may be named differently depending on your unit.

Used to select the image from memory to use as a source for the SIS / TC source currently selected. The Windows Control Panel can be used to upload user-defined images.

9.8 Items associated with the Adjust transitions group

Please note that not all units have this sub-menu – it is only available on some units with overlay and keying abilities.

Transitions control how your unit responds when a source is changed. Fades between sources, as well as wipes and cuts, are possible. The amount of time taken by a transition is controllable from instant transition (a ‘cut’) to several minutes.

Adjust transitions Transition	[Fade]
----------------------------------	--------

This first adjustment controls the type of transition desired: ‘Cut’, ‘Fade’, ‘Wipe’ or ‘Push’.

If you select ‘Cut’ or ‘Fade’, the only remaining menu items will be ‘Switching Fade Time’ and ‘Exit’. Selecting ‘Wipe’ or ‘Push’ exposes additional parameters.

Adjust transitions Switching fade time	[.5]
---	--------

This parameter controls how long a transition from one input to another takes. The value can be 0 (a cut) or several minutes - adjustable in 1/10th second increments.

Adjust transitions Wipe type	[Left -> Right]
---------------------------------	-----------------

If you selected ‘Wipe’ or ‘Push’ for the transition type, then you will be able to specify the ‘movement direction’ of the transition that you want. Both ‘Wipe’ and ‘Push’ support: Left to Right, Right to Left, Up/Down (Top to Bottom), Down/Up (Bottom to Top). ‘Wipe’ also supports: Diagonal and Diamond effect.

Adjust transitions Wipe size	[100]
---------------------------------	-------

Wipe Size sets the ‘granularity’ of the ‘Wipe’ effect and so is only shown when ‘Wipe’ is the transition type. The smaller the number, the more elements there are to the wipe. To clarify by example, if you select the Diamond wipe effect and set a small number into the Wipe Size parameter, you will have a large number of Diamonds present in the transition. On the other hand, a large number loaded into the parameter will result in only one or two diamonds being present during the transition.

9.9 Items Associated with the Adjust buttons group

This menu group allows re-programming of buttons on an attached CC-300 CORIO console, and also on some units with programmable front panel buttons where the labels can be removed and customized.

For certain units without labeled buttons, this menu can be used when ‘Advanced menus=On’ in the System menu – this is to allow re-assignment of buttons when necessary. If required, a firmware update or system restore can be performed to put all buttons back to their defaults.

The Adjust Buttons sub menu allows the reassignment of the factory default button associations. For instance, if you do not want button 3 to be associated with RGB input number 1, you can redirect the button to another input or feature.

*You are strongly cautioned **NOT** to change the default assignments for Window / Output switching for units with multiple windows or outputs (usually the left-hand button). To do so may make control of your unit via the front panel extremely cumbersome.*

Adjust buttons Button [1] =	Toggle ABZ
---------------------------------	------------

To change a button assignment, change the button number to match the one to alter, and then choose the new button assignment.

Adjust buttons Shift [1] =	Toggle 12
--------------------------------	-----------

Once altered to your new assignment, it is recommended that you store your new settings.

Adjust buttons CC-300 btn [1] =	CV1
-------------------------------------	-----

This menu lets you change the assignment of each button on an attached CC-300 unit. If you have multiple CORIO2 units attached to a CC-300, then it is advisable to set them all so that their buttons act in the same way for all units

9.10 Items associated with the Adjust ethernet group

(Please note that not all units have this sub-menu.)

Your unit can be remotely controlled via its RS-232 serial port, but some units can also be controlled via a Local Area Network using the Ethernet connector. This provides TCP/IP communications to and from the unit using a custom protocol.

The Adjust Ethernet Menu Group allows the setup of the Ethernet addressing parameters such as IP address and Default Gateway. Access the Adjust ethernet sub-menu and the following adjustments will be possible:

Adjust ethernet IP enabled	[Auto]
-------------------------------	--------

This parameter has three possible states: On, Off and Auto. On and off manually control the Ethernet capability of the unit. When in Auto mode, if a valid Ethernet connection is present, remote control of the unit will automatically default to Ethernet and control via RS-232 is disabled whilst that connection is maintained.

Adjust ethernet IP add.	[10] 1 2 123
----------------------------	---------------

Enter 4 numbers one by one to form the IP address you wish to assign to the unit. The IP address is a series of four numbers between 0 and 255. Anything above 255 is not a valid number in an IP address range. The unit will not allow you to go above 255.

The IP address must be a unique address on your network, and also must be within the sub-net of your network. If you are unsure about which IP address to use or don't have a unique IP address, ask your Network Administrator.

Adjust ethernet IP sub.	255.255. [255.000]
----------------------------	--------------------

Adjust the last 2 numbers to set the sub-net address (also know as sub-net mask) of your network. Again, if in doubt ask your Network Administrator.

Adjust ethernet IP gtwy.	[10] 1 2 123
-----------------------------	---------------

Enter your network's gateway IP address into this menu item. Again, if in doubt ask your Network Administrator. In general, the gateway only needs setting if the unit is being controlled from a different network (e.g. via the internet).

Adjust ethernet IP port	[10001]
----------------------------	---------

Enter the IP port number you wish the unit to communicate on. Keep a note of this as it will be needed when using other devices to communicate with the unit e.g. CC-300.

1A Adjust Ethernet Set new IP data & reboot
--

Certain units require a re-boot once the new IP address has been entered. Once activated, all current settings (including other menu items) will be saved and the unit will re-boot. If you do not see this menu item, then your unit has already implemented your changes and no re-boot is required.

9.11 Items associated with the Adjust resolutions group



The Adjust Resolutions Menu Group only appears when the Advanced Menus function is turned on within the System Menu Group. To turn it on, go to the System Menu Group and then proceed to the item that says “Advanced Menus”. Turn the function ‘On’, exit the Systems menu and return to this menu structure.

The Resolution Database is used by your unit to identify any incoming video signal and is also used to create an output resolution. It is therefore a very important part of the unit’s infrastructure.

Important Cautionary Information

DO NOT ADJUST THESE ITEMS UNLESS YOU’RE CERTAIN YOU KNOW WHAT YOU’RE DOING! THE ONLY METHOD TO UNDO CERTAIN CHANGES IS TO UPDATE THE FIRMWARE.

TRY USING THE AUTOSET, SHRINK, SHRINK POS, TL & BR ADJUSTMENTS FIRST.

Making adjustments here risks creating a non-standard resolution that is not displayable on a monitor. The resolutions and values within the database are industry standards and should not normally be altered by the user. That said, there might be times when it is necessary to create a custom resolution with specific parameters. If circumstances require you to make such a change, please read the following specific notes:

1. *Any changes made to this database take effect instantly and are also stored immediately in non-volatile memory.*
2. *Since this database is used for both input and output image processing, altering a resolution that is used for both (e.g. 1024x768 input and 1024x768 output) may give undesired effects.*

800 x 600 60 Hz Image to adjust	[17]
------------------------------------	-------

Change the value to select resolution you want to alter.



Typically, the image number currently being used for input or output would be already be selected otherwise immediate feedback to your changes will not be available via your monitor.

800 x 600 60 Hz Interlaced	[Off]
-------------------------------	--------

This adjustment specifies whether the image is interlaced or progressive scan. It toggles simply On or Off, so there are no flashing brackets.

800 x 600 60 Hz H.freq.crse	[37.879] kHz
--------------------------------	--------------

Course Frequency Adjust

The H freq.crse (Horizontal Sync Frequency - Course) adjustment provides the option for changing the Horizontal Sync timing Frequency in 100 Hz steps.

800 x 600 60 Hz H.freq.fine	[37.879] kHz
--------------------------------	--------------

Fine Frequency Adjust

The H.freq.fine (Horizontal Sync Frequency) adjustment provides the option for changing the Horizontal Sync timing Frequency in 1 Hz steps. Use this option to fine tune after using the course adjust.

Please note that the internal sync generator may be unable to generate the exact frequency you want.

800 x 600 60 Hz Clks/l [1056] =	40.000MHz
------------------------------------	-----------

This option changes the total number of image pixels on one line of monitor video including the Horizontal sync pulse and blanking time. This is normally in a multiple of 8. It is very important to get this value correct, or many digital display devices, such as TFT monitors, will display an image with an odd moiré effect – such as soft vertical bands spread evenly across the image.

800 x 600 60 Hz Lines/f [628] =	60.317 Hz
-------------------------------------	-----------

This menu controls the total number of lines of video present in the image which includes the vertical Sync pulse, the blanking period and the active video. Changing this option affects the final vertical sync frequency.

800 x 600 60 Hz H/V active	[800] x 600
-------------------------------	--------------

A video frame includes both the active area, the portion of the image normally containing useful visual information, and a resolution value for a given display standard which only expresses the number of pixels visible in an image. The well-known 800 x 600 computer resolution standard simply means that there are 800 pixels/line visible horizontally and there are 600 lines visible vertically.

This item provides a way to change the number of active pixels and lines.

800 x 600 60 Hz H/V Start	[88] x 23
------------------------------	------------

There is a period of time between the end of the Horizontal Sync pulse and the start of Active Video. This portion of the waveform signal is called the “Back Porch”, a term originating with the television broadcasting industry and its RS-170A specification. In practice, this will control where the video image starts on the left side of the monitor without changing the width of the sync pulse itself (another way to control where the image area starts). The two parameters control where the back porch is positioned and they interact to a degree.

Info:

By adjusting these parameters, you control the start of the back porch (with respect to the trailing edge of Horizontal Sync) and also its width. The place where the Back Porch begins with respect to the Horizontal Sync pulse and the width of the Back Porch have a direct bearing on where the active (visible) portion of the image begins. Do not attempt this adjustment without monitoring the results with an oscilloscope.

800 x 600 60 Hz H/V Sync	[128] x 4
-----------------------------	------------

There are standards for all current computer and broadcast resolutions that specify the correct width of both Vertical and Horizontal synchronizing pulses. If you are creating a special, non-standard resolution, you may wish to adjust the pulse width to fit your new requirements. The H/V Sync screen is where that is accomplished.

Info:

Like the H/V Start adjustment, you must use an oscilloscope when making these adjustments so that you know exactly how many milliseconds or microseconds of pulse width you have created. The numbers shown are relative numbers and not an actual time measurement.

800 x 600 60 Hz Sync polarity	[+H+V]
----------------------------------	--------

Sync can be either negative polarity or positive polarity. To further complicate things, it is possible that you may want to make the Horizontal Sync polarity different from the Vertical Polarity. This control allows you to make that change. You have four possible selections:

- +H+V
- H+V
- +H-V
- H-V

9.12 Items Associated with the System group

The final Sub Menu is for adjustments of System parameters. The “System” in this case means the unit’s functions that are generally unrelated to individual inputs, outputs or any of the various production features.

System SW: 16, PT: 12, BT: 13

This screen is an informational screen. Should you require technical assistance with your unit, the technical support personnel may request that you read the contents of this screen to them during the support call.

The first section, “SW”, is the version of the software that is installed on your unit. You can update software via the User Support web site (procedure to be described later in this manual) and the updates are currently free of charge. “PT” refers to Product Type and “BT” means Board Type. Both of these are hardware designators and cannot be changed by the user however both designators are important to support personnel.

System SW date: 2006-7-11

This is an information page showing when the currently installed software was released. The information is useful to the user as he or she compares the date to the website information describing the current software release.



Normally, the user will examine the added features of each new software release and determine if an update is worth doing in their particular operation. The greater period of time between the current date, and the date shown for the currently installed software, the greater the likelihood that there are useful changes and improvements present in the new release.

System TAC#	27-AA-1C-93-F8-33
----------------	-------------------

The TAC number is a unique identifier for the unit and is for use with the PPF value below.

System PPF#	1A-67-2B-9D-50-4F
----------------	-------------------

The PPF number is for units that support the 'Pay Per Feature' system. Extra features in the unit (such as Mix and Key) may be activated using this menu item by entering in the correct numbers and re-starting the unit.

System Push to store

This screen provides a quick and easy way to store all current operating parameters. The unit will remember the set up you are currently using at the time of data storage and also when you next apply power. To store the current settings, press and release the control button.

System Autoset sense	[Medium]
-------------------------	----------

In order for Autoset to work properly, it needs a sufficiently bright full-screen image to examine. The sense level lets you change the brightness threshold for detection of the screen edge between Low, Medium, High and V.high. Medium is the default level, which is recommended for normal use (Windows-type images, etc.)

System OSD on power up	[On]
---------------------------	------

This parameter controls whether the 'welcome' screen is displayed or not on power up for units with an on-screen display – it can be disabled as required. This is useful when a unit is installed as part of an overall system.

System LED brightness %	[90]
----------------------------	-------

This parameter is available on certain units and controls how bright the LEDs on the front panel appear.

C2-3300 SERIES OPERATION MANUAL

System RS232 baud rate	[57600]
---------------------------	---------

This menu item allows the adjustment of the serial baud rate used for RS-232 communications. The rate can be adjusted to 9600, 19200, 28800, 33600, 38800, 57600 and 115200. (This adjustment is provided for those instances where you wish to use the RS-232 control system for your own purposes.) The default baud rate is 57600.

System Buzzer	[On]
------------------	-------

The screen labeled 'Buzzer' is actually the control for turning the "Beep" "On" or "Off". Normally this is left in the "On" position to provide positive feedback that your data entries and parameter changes have been accepted.

System CC-300 A/B bus mode	[Off]
-------------------------------	--------

This menu item changes the function of an attached CC-300 CORIO console unit. When set to 'On' any 'Take' will result in the A & B windows ('buses') being swapped at the end of the Take – so that another 'Take' will put them back to as they were before.

System Resolutions	88
-----------------------	----

This screen is an informational screen showing the total number of the defined resolutions in the resolution database. Future firmware releases may increase the total number of resolutions defined in the database.

System Logos / T-cards	1 / 4
---------------------------	-------

If your units supports Logos or Still Images / Testcards then this screen will display how many are present in the memory of the units.

System Power cycles	41
------------------------	----

Power Cycles refers to how many times the unit has been powered since it left the factory. This is an informational screen. No action is taken regardless of the value shown here, however some users have an equipment cleaning or specification audit procedure and this information may be useful to those users.

System Firmware updates	11
----------------------------	----

Indicates the total number of times the firmware has been changed over the life of the unit. It is quite possible for this to be more than 1, as a unit undergoes numerous tests during production.

System Hours in Use	877
------------------------	-----

This is another informational display for usage audit purposes.

System Temp.C	30 33 43 45
------------------	-------------

Certain units have built-in temperature sensors, and if yours has such a feature then the above menu item will appear. If the ambient temperature of the internal components becomes excessively high or low, the unit will shut down to prevent harm. This display shows the current value of the ambient temperature at four locations within the case and can be an early predictor of a shutdown before the shutdown actually occurs.

Should you experience problems with your unit, Technical Support may request that you give details of these values.

System Fan speed (rpm)	6000
---------------------------	------

Certain units have built-in fans to keep the unit cool. The fan speed is monitored and if it deviates from normal parameters too much, this will be taken as an indication of insufficient airflow over critical components and shutdown action will be taken.

10 RS232 PORT

10.1 Connection

Your unit is fitted with a standard 'D9' plug or socket allowing it to be controlled from a computer or other type of terminal or console with a similar interface. Most computers fitted with an RS232 port, known as a 'COM' port, will have a 'D9' plug on them. To enable connection between the two devices you will require one of two cables as shown below:

D9 connector type on C2 unit	RS232 cable type required for linking to PC
Plug – common on earlier C2 units	'Null-mode' D9 socket to socket
Socket – common on recent C2 units	D9 plug to socket

Should your PC not have an RS232/COM port, it is possible to add an interface card into the PC to add this facility. Another option you could use is a USB to RS232 converter. Both methods will add a COM port to your PC, although you should be aware that these generally do not default to being 'COM1' which is the default most RS232 applications will use.

The default baud rate is 57600 with 8 data bits, 1 stop bit and no parity. This baud rate can be changed in the System menu to suit other programs if need be.

10.2 Communications protocol

The standard communications protocol for your unit is text-based and is detailed on our website. Also on our website, you can find the Windows Control Panel for your unit.

The protocol is also bi-directional (unit and computer both send messages to each other), so that you can send changes to the unit, and it will also respond with any changes made via alternate methods (front panel buttons, menu changes and infra-red control). This enables any attached computer to be aware of any changes made to the unit from an alternative source rather than itself.

What this means is that you can easily find out the exact command to send to the unit to tell it to perform a certain function. This can be seen by the data that is sent back to the computer when changing values on the unit. For instance, just by turning FREEZE on, by pressing the FREEZE button, will cause RS232 data to be sent to the computer that represents the command required to set FREEZE on. A second press, to turn FREEZE off, then sends the computer the command required to turn the FREEZE off.

Note: Any command you send to the unit will be replied to either with an error code or with the actual changed value. This may be different to the one you sent; for example, if trying to set a value too high or too low.

11 RS232 / IP CONTROL SPECIFICATION

PLEASE NOTE: Not all units support RS232 and/or IP (Ethernet) communications – check to see if this feature is present on your unit.

This section outlines how to control a unit via an RS232 or Ethernet link (if fitted to your unit), using ASCII-based commands. It details how to send and receive serial data to perform many of the functions that a user has access to on the unit.

Not all units will support the full range of adjustments listed – this will depend on the complexity of the unit you have.

11.1 Communication protocol basics

Packets of ASCII data containing hexadecimal numbers are exchanged between the unit and controller via an RS232 or IP link (you cannot use both at the same time).

The RS232 standard is 57600 baud, 8 bits, no parity and 1 stop bit, although this can be changed by the user (see 'System' menu).

No flow control is used - however all control packets start with an ASCII 'F', end with carriage-return (13 decimal, 0x0D hexadecimal) and all such packets sent to the unit will be acknowledged (thereby provided software handshaking). Note that a line-feed (LF) should not be sent.

It may take around 30ms (0.03 seconds) for an RS232 command to be actioned and acknowledged – this will vary between different models.

ASCII-hex data is used where a number is encoded into its hexadecimal equivalent with leading zeros – e.g. Where '00' is decimal value 0, '80' is decimal 128 and 'FF' is decimal 255. In other words, two characters are sent for each byte encoded.

Any gap of more than 1 second between the characters of a control command sent will cause a time-out - and previous characters sent will be lost.

Write packets (sending command functions to the unit) are always 20 characters long (including a carriage return at the end). The unit will respond with a full 20 character message indicating what has changed. This returned payload will reflect the actual value of the parameter changed. If the user requests a value out of bounds then the limit value is used, and the payload will then reflect the limited value used.

Read packets (sent to request information from the unit) are always 14 characters long (including a carriage return at the end), the response from the unit will be a 20 byte message with the Write flag (since it is 'writing' the value back to the host) and the ACK flag set.

C2-3300 SERIES OPERATION MANUAL

The ACK flag will be returned as 0 if the command is invalid for some reason – for example a bad FUNCTION, WINDOW, OUTPUT or PAYLOAD value. An ACK=0 message will be otherwise identical to the one you sent, so you know exactly which message has the error.

Any changes made to the unit using the front panel controls will also cause the full 20 byte message to be sent indicating the change that has occurred, thus enabling a program to stay 'in-sync' with the unit. In some cases (such as the execution of a macro) multiple 20 bytes messages will be sent indicating all the parameters that have been changed.

Only one message should be sent to the unit, another message can't be sent until a specific response is received from the unit (the user should look for a message with the same WINDOW, OUTPUT and FUNCTION values as they sent). If no message is received back within 1 second, there is likely to be a hardware communication problem (or wrong baud rate, etc.).

If absolutely required, to simplify programming the user may send packets one after the other with around 100ms (100 milliseconds) between each one. However, this will not work for all packets (such as Zooming into Still Images / Testcards or changing Logos) since this will cause the unit's micro-controller to be busy, so the user must experiment and satisfy themselves that this is possible.

11.2 Packet format

Below is a representation of data bytes in a single packet for a 'Write' to the unit to set a value:

SOP	CMD	CHA	WINDOW	OUTPUT / FUNCTION	FUNCTION	PAYLOAD x 3	CS	EOP
-----	-----	-----	--------	----------------------	----------	-------------	----	-----

Below is a representation of data bytes in a single packet for a 'Read' to the unit to get a value:

SOP	CMD	CHA	WINDOW	OUTPUT / FUNCTION	FUNCTION	CS	EOP
-----	-----	-----	--------	----------------------	----------	----	-----

The table below details the function of each part of the packet:

Packet part	Function
SOP (Start of packet)	This is always the ASCII letter 'F' to indicate the packet start.
CMD (Command)	ASCII-hex byte to indicate the type of command being sent. Each bit in the byte has a different function. Currently only the following bits are defined: Bit 7 = Write (0) or Read (1) request. Messages from the unit are always Writes. Bit 6 = ACK bit. Should be set to 0 for messages to the unit. ACK=1

C2-3300 SERIES OPERATION MANUAL

	<p>returned means message was okay. ACK=0 returned means an error was present in the message.</p> <p>Bit 5 = 0 Reserved for future use. Bit 4 = 0 Reserved for future use. Bit 3 = 0 Reserved for future use. Bit 2 = 1 This bit *must* be set. Bit 1 = 0 Reserved for future use. Bit 0 = 0 Reserved for future use.</p>
<p>CHA (Channel)</p> <p>SOURCE</p> <p>or</p> <p>MACRO NUMBER</p>	<p>This byte has multiple uses, and defaults to 0 unless used for:</p> <p><u>CHA</u> When a channel number is used in the Adjust Sources section (see later).</p> <p><u>SOURCE</u> Byte to indicate the source channel to be altered (if appropriate). 0x10 = RGB1, 0x11 = RGB2, 0x12 = RGB3, etc. 0x30 = CV1, 0x31 = CV2, 0x32 = CV3, etc. 0x40 = YC1, 0x41 = YC2, 0x42 = YC3, etc. 0x50 = SDI1, 0x51 = SDI2, etc. 0xD0 = OUT1, 0xD1 = OUT2, etc. 0xF0 = TC1, 0xF1 = TC2, etc.</p> <p><u>MACRO</u> Or – for Macro related commands: Bit 7..4 = 0 Reserved Bit 3..0 = Macro number</p>
<p>WINDOW / LOGO / BORDER</p>	<p>Bit 7 = 0 (Reserved). Bit 6..0 = Represents the window to be adjusted (for multi-channel units only). E.g. Window 'A' (the default for single-channel units) is sent as '41' since 0x41 is ASCII for 'A'. 0x61 is ASCII for 'a' (a Logo) and is sent as '61'.</p>
<p>OUTPUT & FUNCTION HIGH</p>	<p>Bit 7..4 = Number representing the output to adjust 0 = Output 1, 1 = Output 2 (for multi-channel units). Bit 3..2 = Reserved (set to 0). Bit 1..0 = Bits 9 & 8 of the function code. (Remainder of bits [7..0] are in FUNC LOW.) E.g. If the function code is 0x234, and we want to adjust Output 2, then this byte is 0x12</p>
<p>FUNCTION LOW</p>	<p>ASCII-hex byte to indicate the lowest 8 bits of the actual function to set or receive (e.g. change Zoom value). A later table details all the functions available.</p>
<p>PAYLOAD x 3 bytes</p>	<p>A series of ASCII-hex bytes carrying the data to send. Read requests have no payload - the payload is in the data sent back. Write packets require a payload, and this is always in 'triple-bytes' - i.e. 3 bytes are required, MSB first. e.g. '000001' is 1 in decimal, '010000' is 65536 in decimal, and 'FFFFFF0' is -16 in decimal.</p>

C2-3300 SERIES OPERATION MANUAL

CS	ASCII-hex byte that is the (check) sum of all previous bytes (excluding the SOP 'F' character). E.g. The command F0400410082000001C8 has the checksum of $04+00+41+00+82+00+00+01=C8$, so the complete command to send is F0400410082000001C8. A short-cut for debugging allows the checksum to be replaced by 2 question marks, so in the previous example you could send F0400410082000001??. Instead. This is purely for test and debugging - you should normally use a checksum to ensure data validity.
EOP	This is a carriage return (no line-feed) - ASCII code 13 (decimal).

11.3 Function list

These are grouped together into their associated on-screen menus.

Your unit and this manual should be used to determine the actual function of each of the following, as only the menu text is listed here. Where an equivalent menu item does not exist on your unit, then that feature is not supported on.

Function codes are given in hexadecimal and adjustment range is in decimal (but always sent as hexadecimal!).

For dual-channel units the mode of operation also restricts what Window and Output can be used the following table shows the allowed combinations:

Mode	Allowed Window and Output combinations
Switcher	Output 1 (0x00) and Window A (0x41) / Z (0x5A) / Logo a (0x61)
Independent	Output 1 (0x00) and Window A (0x41) / Z (0x5A) / Logo a (0x61) OR Output 2 (0x01) and Window B (0x42) / Z (0x5A) / Logo b (0x62)
Dual PIP	Any combination of Output and Window

The following table is a list of all menu functions, their related function number and valid range of adjustment.

Please note that not all items will be available on all units.

Menu text	CHA	FUNC (Hex)	Range of adjustment (decimal)
Top level			
Mode (Dual-channel units only)		109	0 = Switcher 1 = Independent 2 = Dual PIP
Preset number		225	0 to 9 (=Preset 1 to 10)
Preset load		226	Set to 1 to load – automatically resets to 0.
Preset store		227	Set to 1 to store – automatically resets to 0.
Preset erase		228	Set to 1 to erase – automatically resets to 0.

C2-3300 SERIES OPERATION MANUAL

Adjust outputs			
Output enable		170	0=Blanked, 1=Active
Lock source (connector)		149	0x10 to 0x1F = RGB1 to RGB16 0x30 to 0x3F = CV1 to CV16 0x40 to 0x4F = YC1 to YC16 0x50 to 0x5F = SDI1 to SDI16 0xD0 = OUT1, 0xD1 = OUT2 0xF0 = TC1, 0xF1 = TC2
Lock method		10A	0 = Off 1 = Genlock 2 = Lock & Mix 3 = DARSlock (some units only) 4 = Frm.lock (some units only)
Lock H Shift		14A	-4096..4096
Lock V Shift		14B	-4096..4096
Output resolution		083	1..1000
Output image type analogue		0E2	0 = RGBHV 2 = RGsB 3 = YUV 4 = tYUV 7 = tIRGB
Output image type digital		16C	0 = RGBHV 3 = YUV 9 = Not available
HDCP required		233	0..1, Off, On (if display supports it)
HDCP status		234	0=Unavailable 1=Supported 2=Active 3=Repeater supported 4=Repeater active
Background Y		13B	16..235
Background U		13C	16..240
Background V		13D	16..240
SDI optimization		197	0..1, Off, On
Output Standard		101	0 = NTSC/PAL, 1 = PAL-M/PAL-N, 2 = SECAM
Output CV/YC IRE		133	-7.5..12.5
Output CV/YC Hue (degrees)		139	-22..22
Output SC/H Phase		085	-180..180
Output Luma Bandwidth		134	0,1,2 = Low, Medium, High
Output Chroma Bandwidth		135	0,1,2 = Low, Medium, High
Output Chroma delay		137	-4..3
PAL WSS		130	0 = Off 1 = 4:3 Full format 2 = 14:9 Letterbox centre

C2-3300 SERIES OPERATION MANUAL

			3 = 14:9 Letterbox top 4 = 16:9 Letterbox centre 5 = 16:9 Letterbox top 6 = >16:9 Letterbox centre 7 = 14:9 Full format 8 = 16:9 Full format
Take		11E	0->1 = Perform a Preview -> Program transition
Audio amp. Volume		201	-16 to 15
AES/SDI Chan. 1 source		20B	0x00 to 0x07 = SDI1-1 to SDI1-8 0x08 to 0x0F = SDI2-1 to SDI2=8 0x10 to 0x1F = AES1 to AES16 0x20 = AFV (audio follow video)
AES/SDI Chan. 2 source		20C	
AES/SDI Chan. 3 source		20D	
AES/SDI Chan. 4 source		20E	
AES/SDI Chan. 5 source		20F	
AES/SDI Chan. 6 source		210	
AES/SDI Chan. 7 source		211	
AES/SDI Chan. 8 source		212	
Adjust windows			
Program source / Window source (connector)		082	0x10 to 0x1F = RGB1 to RGB16 0x30 to 0x3F = CV1 to CV16 0x40 to 0x4F = YC1 to YC16 0x50 to 0x5F = SDI1 to SDI16 0xD0 = OUT1, 0xD1 = OUT2 0xF0 = TC1, 0xF1 = TC2
Select Universal source		241	0xE0 to 0xEF select universal inputs 1 to 16
Source resolution		0F8	Read only – returns # of resolution
Window Enable		12B	0..1 = Off, On
Zoom level %		086	100..1000
Zoom level H %		103	100..1000 (only used in Advanced A/R mode)
Zoom level V %		105	100..1000 (only used in Advanced A/R mode)
Aspect ratio in		107	0.1:1..9.99:1 (read only)
H/V zoom pan % (H)		09F	0..100
H/V zoom pan % (V)		0A0	0..100
Image freeze		09C	0..1 = Off, On
H/V crop % (H)		223	0..100
H/V crop % (V)		224	0..100
H/V out shift (H)		0AD	-4096..4096
H/V out shift (V)		0AE	-4096..4096
Shrink level %		087	10..100
Shrink level H %		104	10..100 (only used in Advanced A/R mode)
Shrink level V %		106	10..100 (only used in Advanced A/R mode)
Shrink enable		18E	0..1 = Off, On
H/V shr. pos.%(H)		0DA	0..100
H/V shr. pos.%(V)		0DB	0..100

C2-3300 SERIES OPERATION MANUAL

In (top-left H)		21B	
In (top-left V)		21D	
In (H size)		21C	
In (V size)		21E	
Out (top-left H)		21F	
Out (top-left V)		221	
Out (H size)		220	
Out (V size)		222	
Aspect change		190	0..2 = Normal, Letterbox, Pillarbox
Aspect adjust		102	0..1 = Simple, Advanced
Flicker reduction		092	0..3 = Off, Low, Med, High
Image smoothing		0A1	0..2 = Off, Med, High
Image flip		095	0..3 = Off, Horiz., Vertical, H & V
Temporal interpolation		229	0..1 = Off, On
Max fade level		10F	0..100 = Fade level %
Fade out / in		193	-1 = Fade out 0 = No action 1 = Fade in
Layer priority		144	0..5 = Layer priority
Headphone volume		0FD	-16..15 (-16=Mute)
Audio vol. (volume)		206	-128..127 (for digital audio processing)
Audio vol. (on/off)		207	0..1 = Off, On (for digital audio processing)
Adjust keys (on certain models only)			
Keyer enable		127	0.. 1 = Off, On
Y key min/max (min)		0AF	0..255
Y key min/max (max)		0B2	0..255
Y key Softness		121	0..255
Y key Invert		122	0..1 = Off, On
U key min/max (min)		0B0	0..255
U key min/max (max)		0B3	0..255
U key Softness		123	0..255
U key Invert		124	0..1 = Off, On
V key min/max (min)		0B1	0..255
V key min/max (max)		0B4	0..255
V key Softness		125	0..255
V key Invert		156	0..1 = Off, On
Swap fore / background		144	0..1 = Off, On
Adjust keyers – edge blending (on certain models only)			
Edge Blend		180	Bit 0 = Left edge active Bit 1 = Right edge active Bit 2 = Top edge active Bit 3 = Bottom edge active
E.blnd guides		18F	0..2 = Off, Auto, On
E.blnd size H		18B	0.. limited by H width
E.blnd size V		18C	0.. limited by V height

C2-3300 SERIES OPERATION MANUAL

E.blnd gamma H		188	1..150 1=0.01, 150=1.50
E.blnd gamma V		18D	1..150 1=0.01, 150=1.50
E.blnd comp cent		198	0..99
E.blnd comp side		19D	0..99
Logos (on certain models only)			
Logo enable		12B	0..1 = Off, On
Logo number		143	0..9 Logo selection
H/V out shift (H)		0AD	0..100 %
H/V out shift (V)		0AE	0..100 %
Max fade level		10F	0..100%
Layer priority		144	0..5
Borders (on certain models only)			
Border enable		150	0..1 = Off, On
Border H size		152	0..99
Border V size		151	0..99
Border H offset		153	0..99
Border V offset		154	0..99
Border Opacity		158	0 (fully transparent) ..100 (solid)
Border Y		155	16..235
Border U		156	16..240
Border V		157	16..240
Adjust sources			
Source to adjust. <i>This only changes what's shown in the menu – use the CHA values below to change settings of a source.</i>	CHA	116	0x10 to 0x1F = RGB1 to RGB16 0x30 to 0x3F = CV1 to CV16 0x40 to 0x4F = YC1 to YC16 0x50 to 0x5F = SDI1 to SDI16 0xD0 = OUT1, 0xD1 = OUT2 0xF0 = TC1, 0xF1 = TC2
Still Image / Testcard	F0..F1	0DC	0..10
Autoset	10..1F	0FE	1= Start Autoset procedure
Aspect correct	10..5F	240	0=Fill (default) 1=Aspect, 2=H-fit, 3=V-fit, 4=1:1
EDID to use	10..1F	243	0..7 to specify EDID entries 1..Mon
EDID capture entry#	10..1F	244	0..7 to specify EDID entries 1..Mon
EDID capture Grab	10..1F	245	Set to 1 to Grab. Auto-resets to 0.
HDCP advertise (DVI)	10..1F	237	0=Off, 1=On
HDCP status (DVI)	10..1F	238	0=Inactive, 1=Active
TL pos. adj. (left)	10..FF	0B6	-100..100
TL pos. adj. (top)	10..FF	0B7	-100..100
BR size adj. (right)	10..5F	0DE	-100..100
BR size adj. (bottom)	10..5F	0DF	-100..100
Audio input source (internal)	10..FF	242	0..4 Selects inputs 1 to 4 + Mute.
OPTION audio input	10..FF	0D0	0..9 = Channels 1 .. 10 on A2-2000

C2-3300 SERIES OPERATION MANUAL

Audio vol	10..FF	0CF	-16..15 (-16=Mute)
Bal	10..FF	0D1	-15..15
On source loss (was Deglitch)	10..5F	0A3	0=Show, 1=Freeze, 2=Blue, 3=Black, 4=Remove
Source stable (read only)		22A	0=Unstable, 1=Stable
Input pixel phase	10..5F	091	0..31
RGB input type	10..1F	0C1	0 = Auto 1 = D-RGB 2 = D-YUV 3 = A-RGB 4 = A-YUV
RGB contr. (red)	10..1F	0C5	75..150
RGB contr. (green)	10..1F	0C6	75..150
RGB contr. (blue)	10..1F	0C7	75..150
YUV setup level	10..1F	23E	0=0 IRE, 1=7.5 IRE
De-int.	10..FF	0B8	0..6 = Normal, Auto, Film 3:2, M.comp.low, M.comp.med., M.comp.high, Frame/bob
(Film mode detected)	10..FF	0E3	0..1 = Not detected, Detected
Diagonal interpolation	10..FF	22B	0..1 = Off, On
Noise reduction	10..5F	23F	0..1 = Off, On
Bright	30..5F	0BB	0..180
Contrast	30..5F	0BC	0..180
Saturation	30..5F	0B9	0..180
Hue	30..5F	0BA	-180..180
Sharpness	30..5F	080	-7..+7
Luma delay	30..5F	0BD	-4..3
Field swap	10..FF	0C9	0..1 = Off, On (swaps odd/even fields)
Field Offset	10..FF	196	0..7 = -4..+3 (defaults to 4 = 0)
<i>For units with digital audio processing:</i>			
Audio channel 1	10..FF	213	0x00 to 0x07 = SDI1-1 to SD1-8 0x08 to 0x0F = SDI2-1 to SDI2=8 0x10 to 0x1F = AES1 to AES16
Audio channel 2	10..FF	214	
Audio channel 3	10..FF	215	
Audio channel 4	10..FF	216	
Audio channel 5	10..FF	217	
Audio channel 6	10..FF	218	
Audio channel 7	10..FF	219	
Audio channel 8	10..FF	21A	
Adjust audio (on certain models only)			
Source to adj		203	0x00 to 0x07 = SDI1-1 to SD1-8 0x08 to 0x0F = SDI2-1 to SDI2=8 0x10 to 0x1F = AES1 to AES16
Volume trim		205	-128 to 127
Delay adjust		204	-100 to 5000
Adjust transitions (on certain models only)			
Transition type		112	0..3 = Cut, Fade, Wipe, Push

C2-3300 SERIES OPERATION MANUAL

Switching fade time		0F5	0 (off) to 50 (5.0 seconds)
Wipe type		145	0 = Left -> Right 1 = Right -> Left 2 = Up -> Down 3 = Down -> Up 4 = Diagonal 5 = Diamond
Wipe Size		146	10..2000
Audio Control (S2-106AD Only)			
Sample frequency		191	0..4 = Bypass, 32, 44.1, 48, 96kHz
Audio delay		192	0..999 = delay in ms (restricted depending on Sample frequency)
Adjust resolutions			
Note: You MUST set the 'Image to adjust' value to the correct value first, and only then change the other values - otherwise you may be adjusting the wrong entry. The user should not adjust the 'Image to adjust' entry using the front panel whilst also accessing it via RS232			
Image to adjust		081	1..1000
Interlaced		0CA	0..1 = Off, On
H.freq.crse		0BE	10000..200000
H.freq.fine		0BF	10000..200000
H/V active (H)		096	64..2047
H/V active (V)		097	64..2047
H/V start (H)		08B	0..1023
H/V start (V)		08C	0..1023
Clks/l		08D	64..4095
Lines/f		08E	64..2047
H/V sync (H)		08F	8..1023
H/V sync (V)		090	1..1023
Sync polarity		094	0..3 = ++, +-, -+, --
System			
SW (Software version)		0D2	Read only
PT (Product type)		0C4	Read only
BT (Board type)		0C2	Read only
Advanced menus		11D	0..1, Off, On
Autoset Sense		0FF	0..3 = Low, medium, high, v.high
OSD on Power up		189	0..1, Off, On
RGB1 termination		199	0..2, Off, On, Auto
Store		0C8	Set to 1 to store
Buzzer		0CB	0..1 = Off, On
CC-300 A/B bus enable		202	0..1 = Off, On
Power cycles		0D6	Read only
Firmware updates		0DD	Read only
Hours in use		0D7	Read only

C2-3300 SERIES OPERATION MANUAL

Resolutions		0D8	Read only
Number of Still Images / Testcards		0D9	Read only
Number of logos		14F	Read only
Board temp. (deg.C)		0CD	Read only
Air temp. (deg.C)		148	Read only
Regulators temp.(deg.C)		147	Read only
PLD temp. (deg.C)		111	Read only
Fan speed (rpm)		0CE	Read only
Led brightness		12C	0..100
LCD backlight		200	0..1 = Off, On
RS232 Baud rate		0AB	0..6 = 9600, 19200, 28800, 33600, 38400, 57600, 115200
TAC number 0		15D	Read only
TAC number 1		15E	Read only
TAC number 2		15F	Read only
TAC number 3		160	Read only
TAC number 4		161	Read only
TAC number 5		162	Read only
MAC number (IP port)		208	Read only – bytes reversed!
Not part of menu system			
Front panel lock		0FC	0 = unlocked, 1 = locked

11.4 Examples

Each example shows the packet sent to the unit and its response. When a byte is not required to be sent it is indicated by a '-' in the table below (since a Read is 6 bytes shorter than a Write). Each character shown below is sent as a ASCII character so F0400 is sent as 'F' '0' '4' '0' '0'.

Packet sent

Packet returned

SOP	CMD	CHA	WIN	OUT	FUN	PAY	CS	EOP	SOP	CMD	CHA	WIN	OUT	FUN	PAY	CS	EOP
-----	-----	-----	-----	-----	-----	-----	----	-----	-----	-----	-----	-----	-----	-----	-----	----	-----

Set output 1 window B Source to RGB2

F	04	00	42	00	82	000011	D9	CR	F	44	00	42	00	82	000011	19	CR
---	----	----	----	----	----	--------	----	----	---	----	----	----	----	----	--------	----	----

Set output 1 window A to Enable advanced aspect control

Note checksum is ?? for debugging

F	04	00	41	01	02	000001	??	CR	F	44	00	42	01	02	000001	8A	CR
---	----	----	----	----	----	--------	----	----	---	----	----	----	----	----	--------	----	----

Set 1A Shrink to 110 – invalid max for shrink is 100

F	04	00	41	00	87	00006E	??	CR	F	44	00	41	00	87	000064	70	CR
---	----	----	----	----	----	--------	----	----	---	----	----	----	----	----	--------	----	----

Read 1C Zoom level – invalid as window C does not exist

F	84	00	43	00	86	-	??	CR	F	04	00	43	00	86	000000	CD	CR
---	----	----	----	----	----	---	----	----	---	----	----	----	----	----	--------	----	----

Read 1B Zoom level

Zoom = 100

C2-3300 SERIES OPERATION MANUAL

F	84	00	42	00	86	-	??	CR	F	44	00	42	00	86	000064	70	CR
---	----	----	----	----	----	---	----	----	---	----	----	----	----	----	--------	----	----

Set baud to 9600

F	04	00	42	00	AB	000000	F0	CR	F	44	00	42	00	AB	000000	30	CR
---	----	----	----	----	----	--------	----	----	---	----	----	----	----	----	--------	----	----

Reply is at 9600 baud

Set 1A Zoom = 300

F	04	00	42	00	86	00012C	F7	CR	F	44	00	42	00	86	00012C	37	CR
---	----	----	----	----	----	--------	----	----	---	----	----	----	----	----	--------	----	----

Set 1A Shrink to 50

F	04	00	42	00	87	000032	FE	CR	F	44	00	42	00	87	000032	3E	CR
---	----	----	----	----	----	--------	----	----	---	----	----	----	----	----	--------	----	----

Set 1A Shrink H Posn to 0

F	04	00	42	00	DA	000000	1F	CR	F	44	00	42	00	DA	000000	5F	CR
---	----	----	----	----	----	--------	----	----	---	----	----	----	----	----	--------	----	----

Set 1A Shrink V Posn to 100

F	04	00	42	00	DB	000064	84	CR	F	44	00	42	00	DB	000064	C4	CR
---	----	----	----	----	----	--------	----	----	---	----	----	----	----	----	--------	----	----

11.5 Reading and writing macros

Depending on the unit connected there can be up to 7 macros stored in the unit. These macros can be programmed to perform a specific task, for example enable PIP mode, Position pip window at H=0, V=0, Zoom in to 120%.

The WIN and OUT bytes are not used for macro reading or writing and should be set to WIN=1A and OUT = 0

The CHA byte indicates the macro we are programming / reading / running. Macro 1 to 5 are CHA 0..4, CHA=5 is restore, CHA 6..7 are Macros 6..7.

Macro Restore (CHA=5) is read only, the units restore state is set by sending the Store command (0C8).

Menu text	CHA	FUNC (Hex)	Range of adjustment (decimal)
Macro			
Run macro	0..7	F1	0..1 = Run, Erase macro
Number of items within macro	0..7	F4	Read Only
Function to adjust	0..7	F2	0..4095
Value	0..7	F3	Value for Function

11.5.1 Reading a previously stored Macro

In order to read a macro the following commands must be sent in this specific order – no other commands should be sent between these messages. The CHA in these cases relate not to the source but to the macro we are reading.

Packet sent

Packet returned

SOP	CMD	CHA	WIN	OUT	FUN	PAY	CS	EOP	SOP	CMD	CHA	WIN	OUT	FUN	PAY	CS	EOP
-----	-----	-----	-----	-----	-----	-----	----	-----	-----	-----	-----	-----	-----	-----	-----	----	-----

C2-3300 SERIES OPERATION MANUAL

Read number of items currently stored in Preset 2
read

F	84	01	42	00	F4	-	BB	CR
---	----	----	----	----	----	---	----	----

Returned packet indicates 4 items available to read

F	44	01	42	00	F4	00002	FC	CR
---	----	----	----	----	----	-------	----	----

Read the Function for the first item in the preset / macro

F	84	01	42	00	F3	-	BA	CR
---	----	----	----	----	----	---	----	----

Payload is the Function stored – 86 = Zoom

F	44	01	42	00	F3	000086	?80	CR
---	----	----	----	----	----	--------	-----	----

Read the Data for the first item in the preset / macro

F	84	01	42	00	F2	-	B9	CR
---	----	----	----	----	----	---	----	----

Payload is the data for the function – 100%

F	44	01	42	00	F2	000064	5D	CR
---	----	----	----	----	----	--------	----	----

Read the Function for the second item in the preset / macro

F	84	01	42	00	F3	-	BA	CR
---	----	----	----	----	----	---	----	----

Payload is the Function stored – 87 = Shrink

F	44	01	42	00	F3	000087	81	CR
---	----	----	----	----	----	--------	----	----

Read the Data for the second item in the preset / macro

F	84	01	42	00	F2	-	B9	CR
---	----	----	----	----	----	---	----	----

Payload is the data for the function – 100%

F	44	01	42	00	F2	000064	5D	CR
---	----	----	----	----	----	--------	----	----

The above example shows the read for all the items within macro 0. The first command reads the number of items available in the macro and resets the read address. Then the following items read the function and then the data for each of the items in the preset/macro. Following a read of the data for a macro internally the next item in the macro is selected for reading so it is not possible to read the same item twice without first re-reading the number of items in the macro.

11.5.2 Writing to a macro

In order to read a preset / macro the following commands must be sent in this specific order – no other commands should be sent between these messages.

Packet sent

SOP	CMD	CHA	WIN	OUT	FUN	PAY	CS	EOP
-----	-----	-----	-----	-----	-----	-----	----	-----

Packet returned

SOP	CMD	CHA	WIN	OUT	FUN	PAY	CS	EOP
-----	-----	-----	-----	-----	-----	-----	----	-----

Clear macro

F	04	02	42	00	F1	000001	3A	CR
---	----	----	----	----	----	--------	----	----

F	44	02	42	00	F1	000001	7A	CR
---	----	----	----	----	----	--------	----	----

Write the function for first item in macro 3 = Zoom

F	04	02	42	00	F3	000086	C1	CR
---	----	----	----	----	----	--------	----	----

F	44	02	42	00	F3	000011	01	CR
---	----	----	----	----	----	--------	----	----

Write data for the first item = 100

F	04	02	42	00	F2	000064	9E	CR
---	----	----	----	----	----	--------	----	----

F	44	02	42	00	F2	000011	DE	CR
---	----	----	----	----	----	--------	----	----

Write the function for the second = shrink

F	04	02	42	00	F3	000087	C2	CR
---	----	----	----	----	----	--------	----	----

F	44	02	42	00	F2	000011	02	CR
---	----	----	----	----	----	--------	----	----

Write the data for the second item = 100

F	04	02	42	00	F2	000064	9E	CR
---	----	----	----	----	----	--------	----	----

F	44	02	42	00	F3	000011	DE	CR
---	----	----	----	----	----	--------	----	----

11.5.3 Run and Restore macros

Macros once programmed can be run by sending one of the following commands. By running macro 5 the unit can be restored to its previously saved state, when used in conjunction with the other macros this allows a default setup or baseline for the unit to be created.

Packet sent

Packet returned

C2-3300 SERIES OPERATION MANUAL

SOP	CMD	CHA	WIN	OUT	FUN	PAY	CS	EOP	SOP	CMD	CHA	WIN	OUT	FUN	PAY	CS	EOP
-----	-----	-----	-----	-----	-----	-----	----	-----	-----	-----	-----	-----	-----	-----	-----	----	-----

Restore

F	04	05	42	00	F1	000000	3C	CR	F	44	05	42	00	F1	000000	7C	CR
---	----	----	----	----	----	--------	----	----	---	----	----	----	----	----	--------	----	----

Run macro 1

F	04	00	42	00	F1	000000	37	CR	F	44	00	42	00	F1	000000	77	CR
---	----	----	----	----	----	--------	----	----	---	----	----	----	----	----	--------	----	----

Run macro 2

F	04	01	42	00	F1	000000	38	CR	F	44	01	42	00	F1	000000	78	CR
---	----	----	----	----	----	--------	----	----	---	----	----	----	----	----	--------	----	----

Run macro 3

F	04	02	42	00	F1	000000	39	CR	F	44	02	42	00	F1	000000	79	CR
---	----	----	----	----	----	--------	----	----	---	----	----	----	----	----	--------	----	----

Run macro 7

F	04	07	42	00	F1	000000	39	3E	F	44	02	42	00	F1	000000	7E	CR
---	----	----	----	----	----	--------	----	----	---	----	----	----	----	----	--------	----	----

12 COMMON OPERATIONS

This section provides step by step instructions for some common operations.

12.1 Operation of the Keyer

Some units come equipped with a very powerful Luminance and Chrominance Keyer. The Keyer can take some time to master and below is a breakdown and series of simple steps to help you master the Keyer's operation

When adjusting the values, please bear in the mind the following:

The Y value is the Luminance value, so 0 is black and 255 is very bright (white).

The U value is the B-Y component. This is the difference between the Blue and the Luminance value. If part of an image is black, grey or white, then its value is 128 (being the mid-point).

The V value is the R-Y component. This is the difference between the Red and the Luminance value. If part of an image is black, grey or white, then its value is 128 (being the mid-point).

12.1.1 Preparation:

1. Enter the Adjust windows menu.
2. Select the Source (this will be the foreground).
3. Exit the Adjust windows menu.
4. Enter the Adjust keyers menu.
5. Ensure the Keyer is Off.
6. Set all Y, U and V min/max values to [0] [255].
7. Set all Y, U and V softness values to 0.
8. Set all Y, U and V invert values to Off.
9. Turn the Keyer On.

At this point your source image will have disappeared, since all colors have been keyed out.

12.1.2 Adjustment:

Knowing which color(s) you want to key out from the image, e.g. black to disappear, perform the following set of steps:

1. Increase the Y Key Min from 0 until just before the required color (Key Color) appears.
2. Decrease the Y Key Max from 255 until just before the required color (Key Color) appears.
3. Repeat steps 1 & 2 for the U and V min/max values as well.

Adjust any of the Softness values to improve the key. If your input signal is slightly noisy or if you want to soften the edges within the image, then this may require you

C2-3300 SERIES OPERATION MANUAL

to decrease the 'min' values and increase the 'max' values to broaden the range of colors keyed out.

At this point, only the key color should remain transparent.

13 EDGE-BLENDING SETUP

13.1 Introduction

Edge-blending is a method whereby two or more video/data projectors are used together with part of their images overlapping, thereby creating a wider (or taller) display more suitable for showing wide-screen video images. The term edge-blending relates to the fact that the overlap needs to be carefully handled to prevent the overlap causing image brightness problems.

This guide is intended to summarise how to setup such projectors when used with a suitable number of TV One's CORIO®2 scaling engines. The C2-7000 series are dual processors and therefore require only a single unit to perform both tasks, whereas other units will generally require two units to be used together, with a distribution amplifier on the input so that both units receive an identical video source.

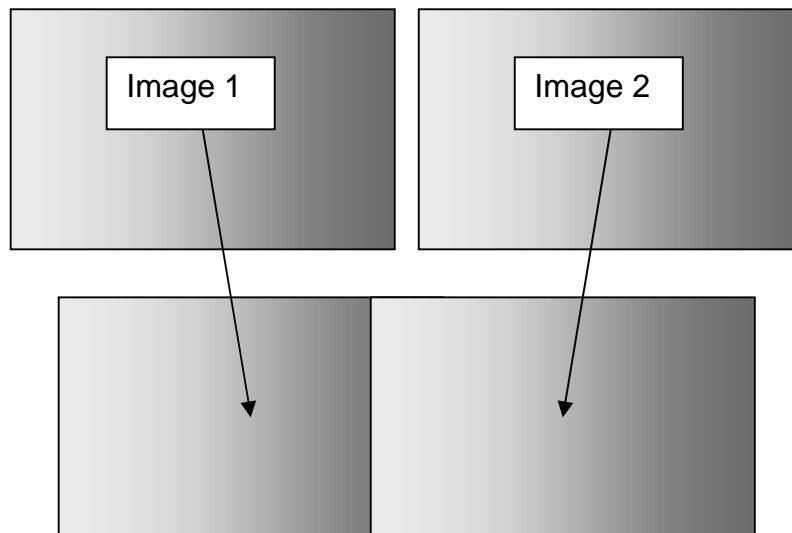

Basic method of overlapping two projection images to create a larger one.

Because the two overlapping areas will create a brighter than normal image, 'blending' is performed on the edges to allow seamless merging of the images together. The 'blend' is basically an S-shaped curve that is applied to gradually reduce the brightness of the image at the edge, so that they can overlap properly:

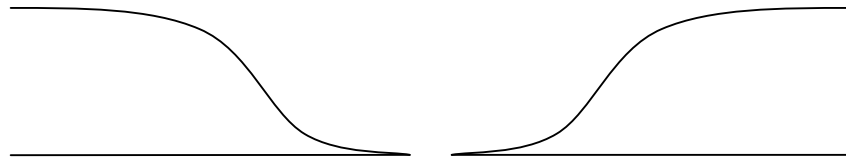

S-curves for left and right projectors, with edges blended.

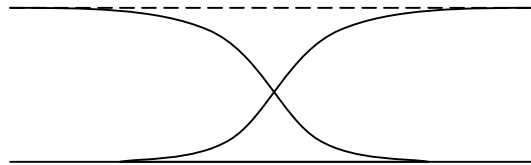

S-curves, when properly overlapping, will add together to result in full brightness.

13.2 Edge-blending requirements

To obtain the best edge-blending results, you will need:

1. A perfectly flat projection screen. This is vital, or it will not be possible to perfectly align your two projected images with each other.
2. Two matched projectors. Every projector on the market is different, with different lenses, projection methods, brightness, contrast, etc. Ideally you will need to identical projectors to obtain the best results.
3. A solid table or mounting bracket. Once you've set up your projectors and aligned them, you will not want them to move – so some method of holding them in place with brackets secured to walls or ceilings, or simply a sturdy table, will be vital.
4. Adjustable mountings (or more preferably projectors with built-in advanced adjustments). Proper alignment of two projectors can be very difficult, but will be aided by using some sort of mounting bracket that is easily adjustable. You may need to be able to move the projectors independently in all directions: left, right, up, down, forward, backward and also be able to tilt them to correct for any rotational errors.
5. Adjustable projectors. Most projectors will offer certain advanced features such as key-stone correction. This will be vital to ensure proper alignment, as it will partly compensate for mounting problems.
6. Of course, you'll need one or more CORIO®2 units (depending on the model) with the latest firmware that supports edge-blending.

13.3 Basic setup of the two projectors

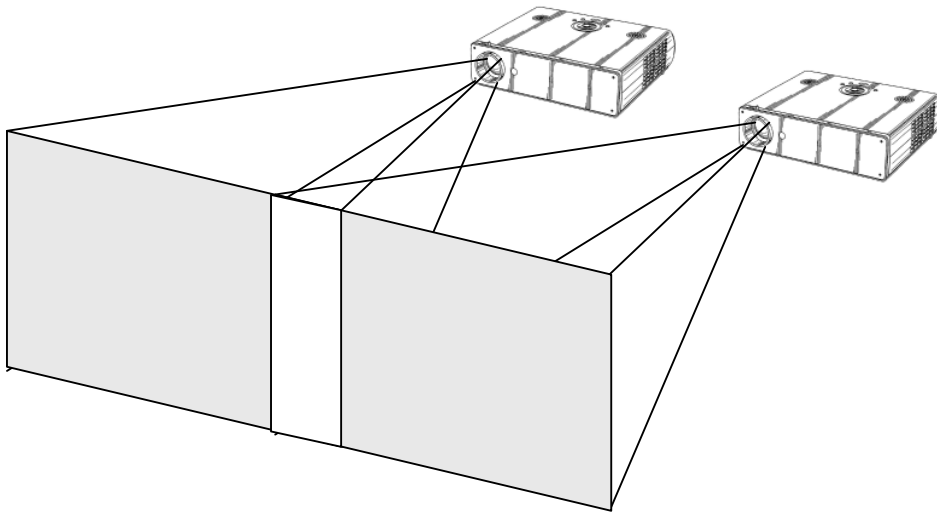

Basic video projector setup showing overlap.

The above diagram shows how the two projects should be placed to create a wider than normal image. The amount by which they overlap is very important, as this will also relate to the zooming values to be used for each of the CORIO®2 scaling engines.

Zooming is required because each projector is showing slightly more than half of the projected image, and thus each channel needs to be zoomed into a different area of the original source picture.

At this point, it is only necessary to place the projector roughly where you would like them to be, with around 15% overlap horizontally. If your projectors are already fixed into position, check that there is around 10% to 20% overlap, or edge-blending will not be possible.

You must also ensure that both projects are in focus with the same zoom settings (if your projector has this). It is often worth doing a 'factory reset' on them to ensure that no other settings (such as gamma correction or tilt) are active.

13.4 Connections to the scaler(s) and projectors

For CORIO®2 units with two scaling engines (such as the C2-7000 series), use outputs 1 and 2 to connect to the left and right projectors respectively.

If two single-channel scalers (such as the C2-1000 or C2-2000 series) are used, then connector unit '1' to the left-most projector, and unit '2' to your right-most projector. Hereafter, we'll talk about Output 1 and Output 2 as referring to unit 1's output and unit 2's output.

For use with dual-channel scalers such as the C2-7000 series, connect your video source (e.g. a DVD player or computer) to an input on the C2-7000 unit. It is not necessary to feed two signals – the C2-7000 unit can use the same signal for both outputs.

For 2 single-channel scalers, you can either use a distribution amplifier so that a single video source is split into 2 signals, or use the 'loop' output available on some units.

13.5 Initial setup

This section describes how to start setting your scaler up. It is vital that your scaler is 'clean' of any user settings, so it is advisable to perform a full factory reset by either re-updating the firmware, or doing a factory reset (see earlier in manual for how to do this).

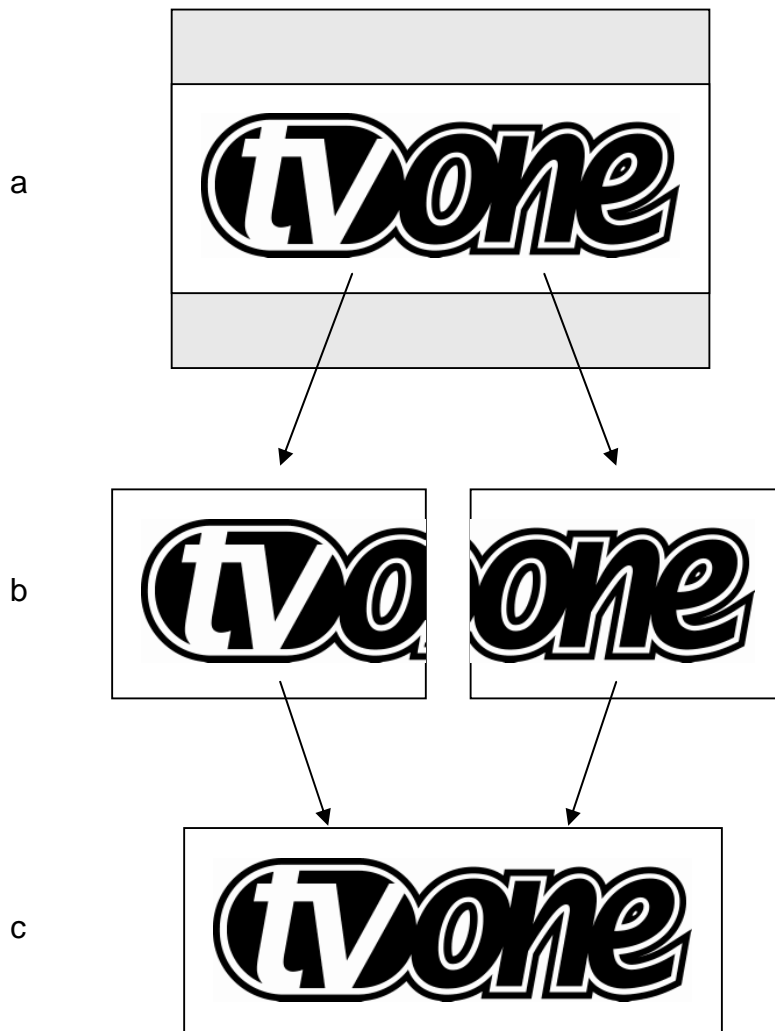

Showing setup of zoom for each channel.

Figures 'a', 'b' and 'c' show how an original wide-screen image is 'split' into two using identical zoom values on Output 1 and Output 2. Zoom values for around

10% to 20% overlap are usually around 180%. In other words, not quite 2x zooming (since that would give no overlap at all).

Figure 'a' shows the original image and 'b' shows the two zoomed images. Note that the two images are at different 'Pan' positions – i.e. they are zoomed into different areas of the image – the left and right-hand sides. Figure 'c' then shows the images re-combined as they should eventually appear on your projection screen.

To produce the above effect, you'll now need to change some settings on the units:

1. On a dual-channel unit, set the unit into 'Independent' mode – this runs both scaling engines independently as 1A and 2B.
2. Go into the 'Adjust outputs' menu and ensure that both scaling engines are outputting the same resolutions. (Hint: use Toggle 1 / 2 (Shift-1) to switch between 1A and 2B on the C2-7000 series.)
3. Go into the 'Adjust windows' menu and ensure that both scalers are set to the same 'Source', which needs to be your original video signal (e.g. from a DVD player).
4. For Output 1 (1A), change the 'Zoom' value to 190%, with H pan% of 0% (fully left).
5. For Output 2 (2B), change the 'Zoom' value to 190%, with H pan% of 100% (fully right).

If your projectors are properly setup and connected, with the scaler active with the above settings, you should now have a very rough overlap of the two images on a single projection screen. Where they do overlap you will see an over-bright part of the image, and most probably some overlapping errors.

13.6 Edge-blending activation

Edge blending is activated in the 'Adjust keyers' part of the menu, as follows:

1. Go into the 'Adjust keyers' menu.
2. For Output 1 (1A), change 'Edge blend' from 'None' to 'R' – so that it's right-hand edge is blended.
3. For Output 2 (2B), change 'Edge blend' from 'None' to 'L' – so that it's left-hand edge is blended.

You will also notice that some red and green lines have appeared. The red lines indicate the edge of the screen, and the green lines indicate the start or end of the blend. If these lines are not present, change 'E.blend guides' to 'Auto' or 'On'. 'Auto' makes them appear only whilst you are in the 'Adjust keyers' menu. 'On' forces them to be on all the time.

13.7 Edge-blending overlap / size

The blend size needs to be the same on both keyers, and is related to both the output resolution ('Output res' in 'Adjust outputs') and the zoom value ('Zoom' in 'Adjust windows').

C2-3300 SERIES OPERATION MANUAL

There is a formula for calculating the edge blend size (E) from the zoom value (Z) and horizontal pixel width of the output (H):

$$E = 2 * H * (1 - Z/200) \text{ [pixels]}$$

For example, with zoom (Z) at 190%, output resolution of 1024x768 (H=1024), we can calculate E as:

$$E = 2 * 1024 * (1 - 190/200) = 102.4 \text{ [pixels]}$$

There is also a formula for calculating the zoom value (Z) from the edge blend size (E) and horizontal pixel width of the output (H):

$$Z = (1 - E / (2 * H)) * 200$$

For example, with E at 150 pixels, an output resolution of 1920 x 1080i (H=1920), we can calculate Z as:

$$Z = (1 - 150 / (2 * 1920)) * 200 = 192 \text{ [%]}$$

For the recommended zoom value of 190%, the following edge blend horizontal sizes should be used for various output resolutions:

Zoom %	Output resolution	Edge blend H size
190	640 x 480	64
190	800 x 600	80
190	1024 x 768	102
190	1280 x 720	128
190	1280 x 1024	128
190	1600 x 1200	160
190	1920 x 1080i	192

To set these edge-blend widths, perform the following:

1. Go into the 'Adjust keyers' menu.
2. For Output 1 (1A), change 'E.blnd size' (the first number) to the H size recommended above.
3. For Output 2 (2B), change 'E.blnd size' (the first number) to the H size recommended above.

It is very important for Outputs 1 and 2 to use the same blend width, or you will not be able to accurately blend your images. However, should your projectors be mismatched, changing the blend width on one or both of them can sometimes help – but this should be done as a last resort.

13.8 Edge-blending guide lines

These lines, as mentioned earlier, are used to aid the alignment of your projectors. They show the area to overlap – the red lines indicate the inside edge of the output

resolution, whilst the green lines indicate the edge of blending. (G marks the green lines, R marks the red, Y marks the yellow, for those reading in black and white.)

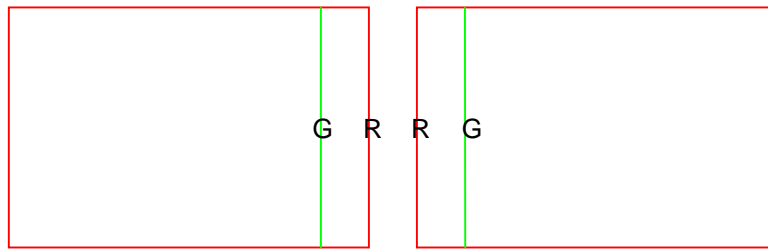

Outputs 1 and 2 with guide lines shown.

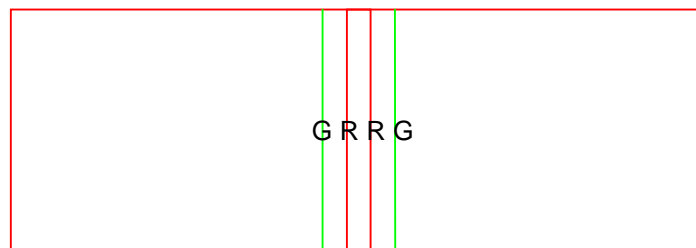

Outputs 1A and 2B partly overlapping.

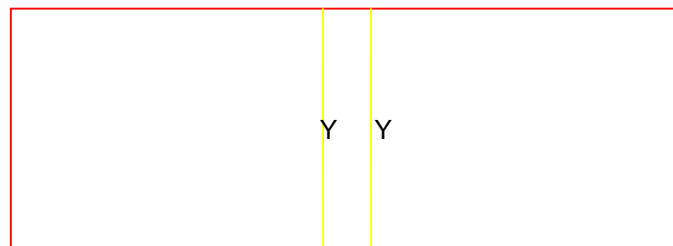

Outputs 1A and 2B perfectly overlapping – the red and green lines turn to yellow when aligned

13.9 Alignment of projectors

This is possibly the most difficult part of properly setting up edge blending. Using the guide lines, you need to fine-tune your projector positions and tilts so that the above-mentioned red and green vertical lines perfectly overlap to produce yellow ones.

Depending on how your projectors are aligned, you'll get different results, each with different solutions as detailed below:

C2-3300 SERIES OPERATION MANUAL

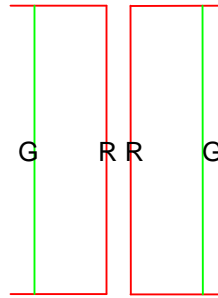
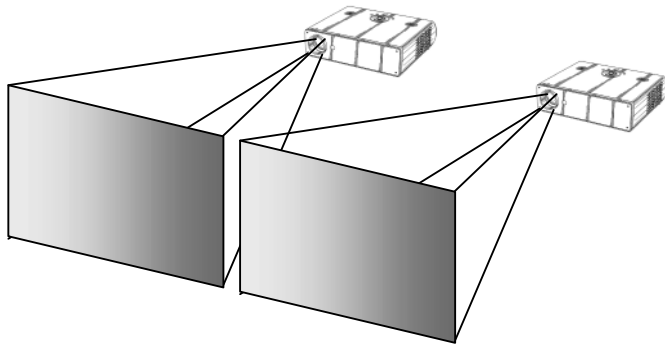

Too far apart – you need around 15% overlap, such that the red and green lines overlap.

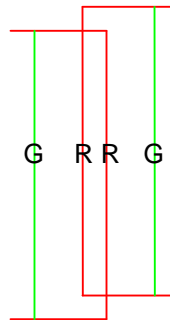
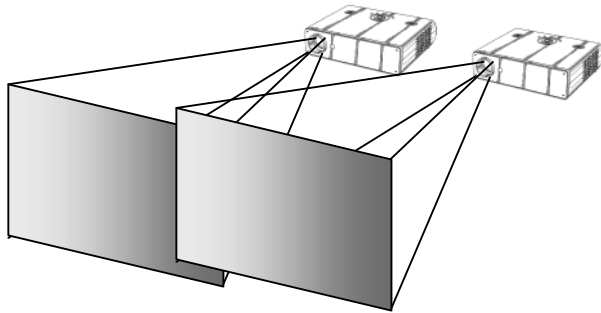

Offset – make sure your projectors are perfectly aligned both horizontally and vertically.

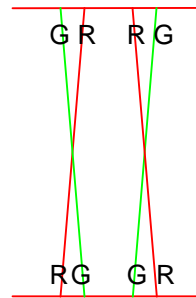
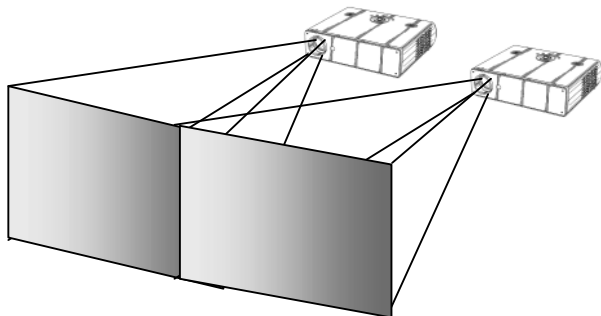

Key-stoning – ensure your projectors have the same keystone values, to produce perfectly aligned vertical lines.

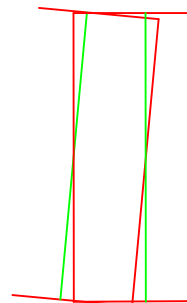
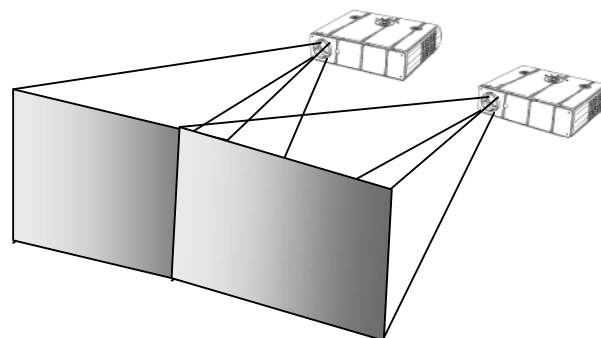

Rotation – one or both of the projectors has a slight tilt. Once corrected, you may then need to re-align them.

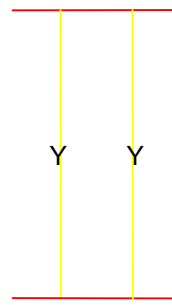
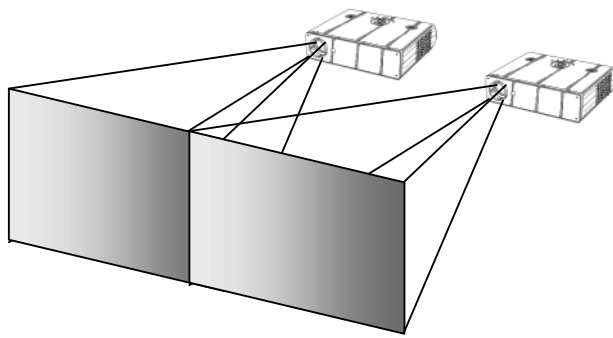

Perfect alignment – your red and green vertical lines should overlap to produce yellow ones.

13.10 Gamma correction

By now you should have two perfectly aligned projectors, but possibly with a brighter than normal overlap. This is most probably because a projector's luminance is not perfectly linear and therefore will need to have what's called 'gamma correction' applied.

Gamma correction is available within the same 'Adjust keyers' menu as the other adjustments. You will need to adjust both output channels gamma correction to be the same, unless you have non-matching projectors.

To change gamma correction:

1. Go into the 'Adjust keyers' menu.
2. For Output 1 (1A), change 'E.blnd gamma' (the first number) until the brighter area starts to dim – note the number required for this.
3. For Output 2 (2B), change 'E.blnd gamma' (the first number) to the same gamma value as per above.
4. Repeat steps 2 and 3, changing up or down as necessary until the bright patch has disappeared.

The 2nd number in the 'E.blnd gamma' is for where you have projectors stacked vertically – e.g. for a 2x2 edge blend arrangement. The 1st number adjust the horizontal blend's gamma value, whereas the 2nd controls the vertical blend's gamma value.

Note that it may not be possible to completely remove a bright patch – this is because some projectors can not actually output completely black images, with some light always leaking through. However, the next adjustment is designed specifically for this.

13.11 Brightness compensation

If you find it impossible to completely remove the centre overlap for all images (i.e. dark images and bright images being projected), then two extra compensation adjustments are provided to help with this.

The compensation is needed because most projectors cannot output pure black – there's always some light 'leaking' to the projection screen. Thus when you're trying to output black, there will be a 'hot area' where the two projectors are now overlapping, of twice the projector's 'black level' output.

The solution is to adjust the 'Eb comp cent' value (the first in the 'Eb comp cent/side' menu) to compensate for this centre brightness error. By increasing this value, it will increase the brightness of the non-overlap area.

To get this value right, you must first make sure that the units connected to the projectors are outputting black – e.g. in the Adjust windows menu you can disable the output. Then increase the 'Eb comp cent' value until the non-overlap area's brightness has increased to be the same as the overlap (centre) area.

The 2nd value ('Eg comp side') is for where horizontal and vertical edge blending is being performed – e.g. a 2x2 arrangement. This value increases the brightness of the overlapping areas, with the exception of the centre 'square' where all projectors overlap.

13.12 Aspect ratio adjustment

Since your original video source is probably 16:9 (or a similar aspect ratio), it will also be necessary to change your vertical zoom value differently to the horizontal one. This is best done after projector alignment by performing the following:

1. Go to the 'Adjust windows' menu and change 'Aspect adjust' to 'Advanced'. This enables separate H & V zoom adjustments.
2. Go to 'Adjust windows' for Output 1 (1A) and you will now be able to adjust the vertical zoom independently of the horizontal zoom. H zoom should be left as it is, so adjust the V zoom until the correct aspect ratio of your output is achieved.
3. Go to 'Adjust windows' for Output 2 (2B) and adjust the V zoom to the same value as Output 1 (1A).

13.13 Locking both outputs together

If your video source contains live (moving) video then it is worthwhile locking one channels' output to the other's – this will eliminate any line or frame drift, which may cause frame-rate conversion problems. This is best done by locking Output 2 to Output 1.

For dual-channel units such as the C2-7000 series, perform the following:

1. Go to 'Adjust outputs'
2. Ensure that '2B' is selected – press Toggle 1 / 2 (Shift-1) if not.
3. Where 'Lock [Off] RGB1' is seen (where RGB1 is the default Lock source), change the Lock source to 'OUT1'.
4. Then change the Lock method from 'Off' to 'Genlock'.

For single-channel units (such as the C2-1000 and C2-2000 series) you can probably only perform locking if RGB1 is available for use (i.e. you are using CV1 or YC1 as your video source). If so, perform the following:

1. Either use a 2nd output from the unit with Output 1, or a distribution amplifier to generate a 2nd identical signal. Feed this into RGB1 on the unit handling Output 2.
2. Go to 'Adjust outputs' for Output 2
3. Where 'Lock [Off] RGB1' is seen (where RGB1 is the default Lock source), change the Lock source to 'OUT1'.
4. Then change the Lock method from 'Off' to 'Genlock'.

13.14 Other setup approaches

The previous setup method relies on your projectors being moved and aligned to the 190% zoom factor. Other setup approaches are also used where the zoom factor is adjusted to the projectors' current position – for instance if they are already fixed into their final positions.

Assuming your projectors are in fixed positions and you can't move them, you will need to adjust the 'E.blnd' H-size for both Outputs 1 and 2 to be the same values such that they overlap, creating the yellow lines mentioned earlier. You will then need to adjust the zoom values according to the formula given earlier. For various zoom and output resolutions, the following values for the edge blending H-size can be used:

Table showing Zoom% values for various Horizontal resolutions and edge blend H size overlaps.

C2-3300 SERIES OPERATION MANUAL

E.blnd H	640x480	800x600	1024x768	1280x720	1280x1024	1600x1200	1920x1080i
50	192	194	195	196	196	197	197
55	191	193	195	196	196	197	197
60	191	193	194	195	195	196	197
65	190	192	194	195	195	196	197
70	189	191	193	195	195	196	196
75	188	191	193	194	194	195	196
80	188	190	192	194	194	195	196
85	187	189	192	193	193	195	196
90	186	189	191	193	193	194	195
95	185	188	191	193	193	194	195
100	184	188	190	192	192	194	195
105	184	187	190	192	192	193	195
110	183	186	189	191	191	193	194
115	182	186	189	191	191	193	194
120	181	185	188	191	191	193	194
125	180	184	188	190	190	192	193
130	180	184	187	190	190	192	193
135	179	183	187	189	189	192	193
140	178	183	186	189	189	191	193
145	177	182	186	189	189	191	192
150	177	181	185	188	188	191	192
155	176	181	185	188	188	190	192
160	175	180	184	188	188	190	192
165	174	179	184	187	187	190	191
170	173	179	183	187	187	189	191
175	173	178	183	186	186	189	191
180	172	178	182	186	186	189	191
185	171	177	182	186	186	188	190
190	170	176	181	185	185	188	190
195	170	176	181	185	185	188	190
200	169	175	180	184	184	188	190
205	168	174	180	184	184	187	189
210	167	174	179	184	184	187	189
215	166	173	179	183	183	187	189
220	166	173	179	183	183	186	189
225	165	172	178	182	182	186	188
230	164	171	178	182	182	186	188
235	163	171	177	182	182	185	188
240	163	170	177	181	181	185	188
245	162	169	176	181	181	185	187
250	161	169	176	180	180	184	187
255	160	168	175	180	180	184	187
260	159	168	175	180	180	184	186
265	159	167	174	179	179	183	186
270	158	166	174	179	179	183	186
275	157	166	173	179	179	183	186
280	156	165	173	178	178	183	185
285	155	164	172	178	178	182	185
290	155	164	172	177	177	182	185
295	154	163	171	177	177	182	185
300	153	163	171	177	177	181	184
305	152	162	170	176	176	181	184

C2-3300 SERIES OPERATION MANUAL

14 WINDOWS CONTROL PANEL

A powerful utility is available for the C2 product range and can be downloaded from our support web site or found on the Product CD (where supplied). To install the application click on the setup file and follow the on screen instructions.

Once installed you will be able to control your unit via either Ethernet or Serial (RS232) and be able to change and store all the settings of the unit.

14.1 Opening screens

When you start the application you will be presented with a splash screen showing the product version number and then the main screen. The toolbar menu for communications allows you to change the communications method that the application will use.

14.1.1 Selecting a serial port connection

Select the **Communications** item from the Communications toolbar. Then click the “Serial” option on the popup window.

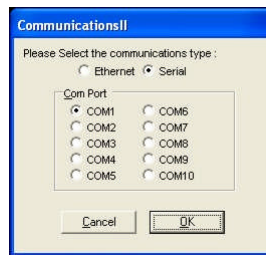

Figure 1 Communications – Serial

The application will support up-to 10 serial ports, all other parameters normally associated with serial communications such as the baud rate are already configured. The application works with a baud rate of 57600 baud only, you should ensure that the baud rate is correctly set in the unit (System menu on the unit – see 9.12) before trying to connect.

14.1.2 Selecting an Ethernet connection

For units where an Ethernet port is provided, select the **Communications** item from the Toolbar Communications. Then select the “Ethernet” option on the popup window, the following options will be shown.

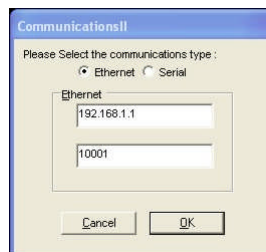

Figure 2 Communications - Ethernet

In the Ethernet section be sure to set the IP address to the same as the address you have set on the unit (units Ethernet menu). The port number used should also reflect the port number on the unit.

If there are multiple units on the network then this port number should be the same for all units, only the IP address must be unique.

14.2 Connecting to a unit

This main screen allows you to operate the application in one of two modes, firstly “Demo” mode which allows you to familiarize yourself with the unit control without having a unit connected. To use demo mode select the product to demo from the dropdown box and then press **Demo mode**.

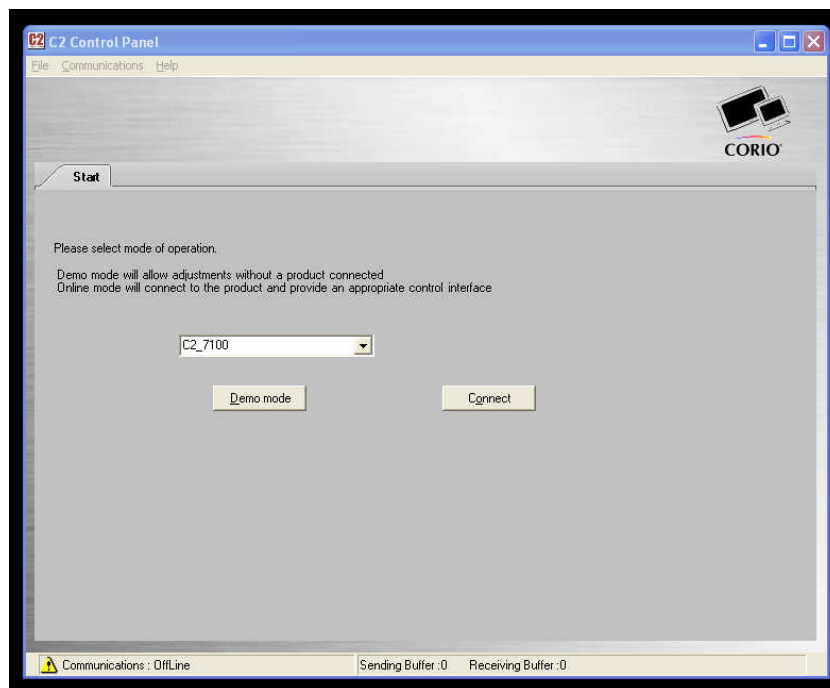

Figure 3 Main screen

Secondly “Connect” mode which connects to a device that you have attached via Ethernet or Serial. On pressing the **Connect** button, the software will detect the unit connected and show the appropriate controls and features.

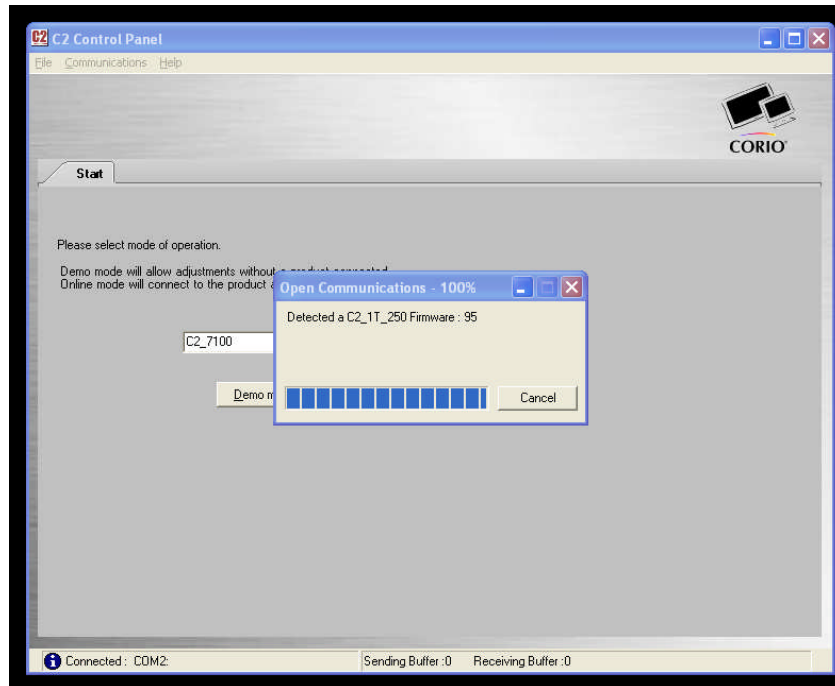

Figure 4 Detecting a unit

Once the application detects and connects to a unit you will be asked if you wish to “synchronize with the unit”, this will read all the settings from the connected unit and update the application.

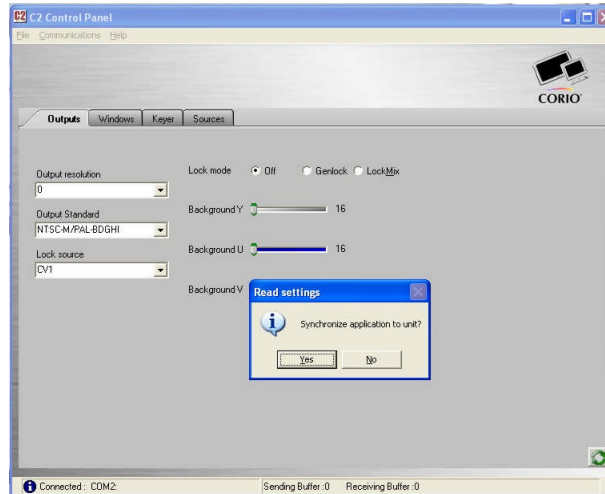

Figure 5 Synchronize application

Once synchronized any changes made on the unit or on the application will be reflected on the unit and the application.

14.3 Application menu's

14.3.1 File menu

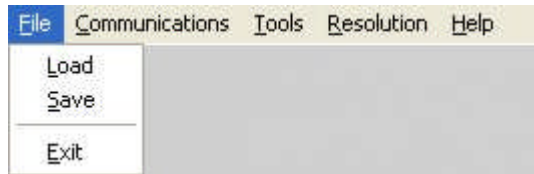

Figure 6 File menu

Across the top of the application are the toolbar menu options. The first menu item is **File** within this menu you can **Save** and **Load** previous setups into the application, these setups contain all the settings of the unit. Following a Load the application will ask if you would like to synchronize the unit, if you do not synchronize then the unit and the application will show different values.

14.3.2 Communications menu

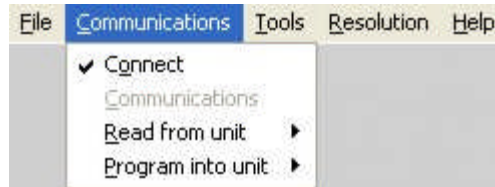

Figure 7 Communications menu

The communications menu provides the **Connect** item which provides a means to disconnect from the unit and return to the main screen. **Read from unit** is very important as it allows selective or all of the settings to be read from the unit. Depending on your unit some of the following **Read from unit** menu items are not available.

- The **Read All** option will read each of the setting sections from the unit and update the application. This item should be selected following connecting to a unit as it will synchronize the unit and the application.
- The **Read Macros** will read the macros that are stored within the unit.
- The **Read Buttons** will read the button assignments from the unit and update the buttons and the buttons tab within the application.
- The **Read Resolutions** will read the complete resolution database that is currently stored in the unit. This step must be performed in order to select resolutions by name and to be able to edit resolutions.
- The **Read Parameters** will read the all of the adjustments from the unit and update the applications.

The last menu available in Communications is **Program into unit** this allows selective or all the settings to be programmed into the unit.

- The **Program All** menu will program each of the settings sections into the scaler.
- The **Program Macros** menu will program only previously read or loaded macros into the unit.

- The **Program Buttons** menu will program the button assignments into the unit
- The **Program Resolutions** menu will program the resolutions into the unit as defined on the resolutions Tab.
- The **Program Settings** menu will program all adjustments into the unit

14.3.3 Tools menu

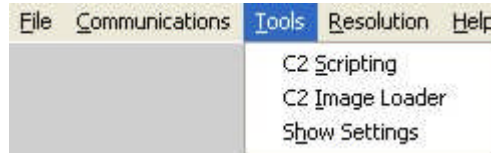

Figure 8 Tools menu

The tools menu provides access to the scripting tool, image loader and show settings. The **Scripting tool** provides the ability to create complex scripts, which can be used to instruct the unit to perform multiple operations with just a single button click.

The **Image Loader** provides the ability to program Logos and Still Images / Testcards into the unit. The source image can be in JPG, BMP or GIF format which is then compressed and downloaded to the unit. For Logos the Image Loader provides the ability to set two key colours that will appear transparent when downloaded into the unit.

Finally the **Show Settings** item will show all the settings that are currently active within the application.

14.3.4 Resolution menu

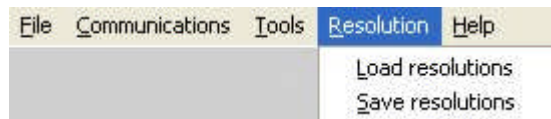

Figure 9 Resolution menu

The resolution menu provides the ability to Load previously saved or downloaded resolutions into the resolution editor. Once a resolution table has been modified then it can be saved to a resolution text file.

14.4 Scripting tool

The scripting tool is a very powerful feature of some units as it allows complex sequences of adjustments to be performed using a single button press.

C2-3300 SERIES OPERATION MANUAL

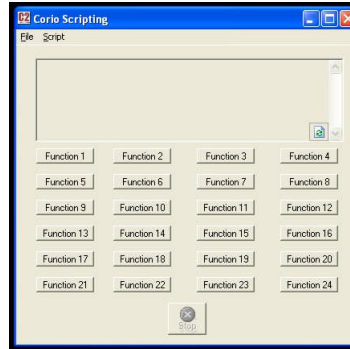

Figure 10 Scripting button screen

Up to 24 buttons/functions can be defined, and each of these buttons/functions can perform multiple actions.

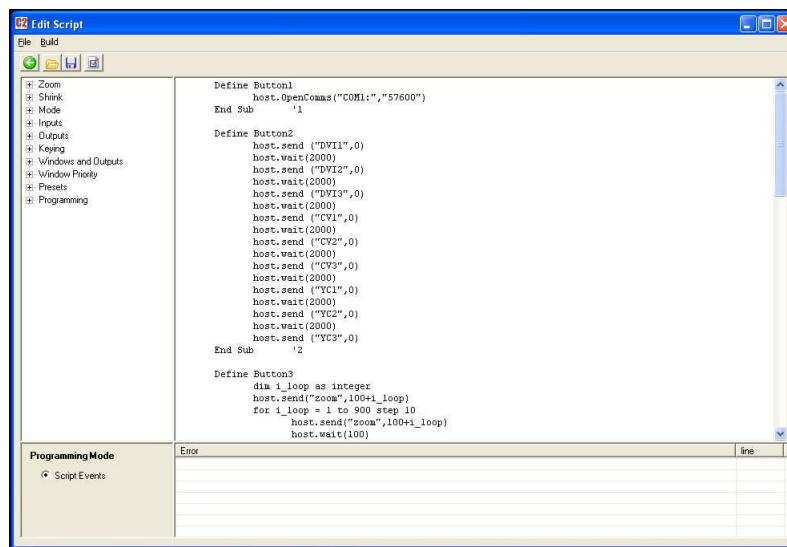

Figure 11 Script editor

In order to edit or create a script select **Script->Edit** from the menu, this will then present the script editor as shown above.

The script editor is based around a simple drag and drop interface, in order to create a button action you drag the required operations to the correct 'Define Button' section. As can be seen in the example above for Button2 we have multiple actions which are cycling sources and then waiting for 2000 milliseconds before selecting the next source.

14.5 Image Loader

On some units it is possible to store Logos and/or Still Images / Testcards. Still Images / Testcards are full screen images that operate much as another input source so they can be shrunk, zoomed, faded, keyed, blended and positioned anywhere on the screen. The Logos are pre keyed and of a fixed size on the unit. The Image loader provides the ability to key out a range of two separate colours, and set the logo size.

14.5.1 Loading Still Images / Testcards

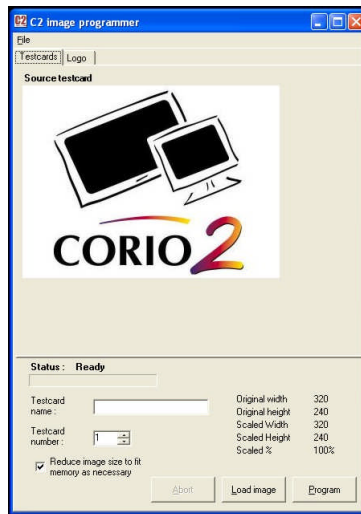

Figure 12 Image loader

To program a Still Image / Testcard into the unit select the 'Testcards' tab from the image programmer screen and then press **Load Image**.

You can select JPEG, BMP and GIF images. The image will be loaded and shown on the screen. You should then enter a name for the image – this name, limited to 24 characters, will be shown on the unit when it is selected as a source.

The image number is the 'slot' that the image will be loaded into within the unit, there are between 10 and 15 'slots' available depending on the unit type.

Pressing program will convert the image into its raw RGB values and then compress it, if the image is too large once compressed then the programming sequence will stop and report that the image is too large / complex.

Selecting the 'Reduce image size to fit memory' option will cause the application to automatically shrink the image and then recompress until the image will fit into the units memory. This will reduce the quality and detail in the image, but make it fit into the unit. If the resizing of the image is unacceptable then the complexity of the image may need to be reduced. You should refer to 14.5.3 for a guide to producing an image that will be suitable for the memory space available in the unit.

14.5.2 Loading Logos



Figure 13 Logo Loader

To program a logo into the unit select the 'Logos' tab from the image programmer screen and then press **Load Image**.

You can select JPEG, BMP and GIF images. The image will be loaded and shown on the screen. You should then enter a name for the Logo – this name, limited to 24 characters, will be shown on the unit when it is selected.

The Logo number is the 'slot' that the Logo will be loaded into within the unit, there are between 10 and 15 'slots' available depending on the unit type.

If you do not need to key out any part of the logo then simply press 'Program' Pressing program will convert the image into its raw RGB values and then compress it, if the image is too large once compressed then the programming sequence will stop and report that the image is too large / complex.

To key part of the image select the 'Keyer' checkbox. You can now use the mouse right and left click to select up to two colours to key from the image. Pressing 'preview key' effects will refresh the image showing the keyed areas as transparent. The 'Invert preview background' checkbox will for preview purposes add a background to keyed image to allow for easier key adjustments.

Should the edges of the keyed portions of the image still show shades of the Key colour then the softness adjustment should be altered until the required key effect is reached. If the softness adjustment is not sufficient then selecting the 'Edge filter' option will detect edges of the key areas and apply further softness.

Once programmed if the logo is too large on the unit output then adjust the 'Logo shrink' and reprogram the logo.

14.5.3 Maximum Image size – how large can my Logo / Still Image / Testcard be?

The image size for a Logo or Still Image / Testcard is limited by the amount of memory available in the unit; this is approximately 128kbytes of compressed image for a Still Image / Testcard and approximately 32kbytes for a Logo. The compression used by the Image loader is Run Length Compression.

This provides excellent compression for simple images with well defined contiguous blocks of colour such as logos. However the effectiveness of the compression is reduced when images are anti-aliased, for example:

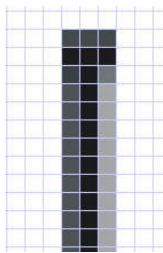

If we take a single line of pixels and look at them closely we will see for a non aliased image solid pixels of one colour .If we look at a line when anti-aliased we can see that no longer is the leg made of solid pixels but of varying shades this will cause an increase in complexity and reduction in compression.

So how large can the source logo / image be? The size of the original image is a minor factor; the most important factor is the complexity and amount of anti-aliasing that is present.

14.6 Resolution Editor

On some units it is possible to modify the resolutions that can be output and input; where this is available a Resolutions tab will be shown on the main screen. This tab will show the resolution database editor, and creation tool.

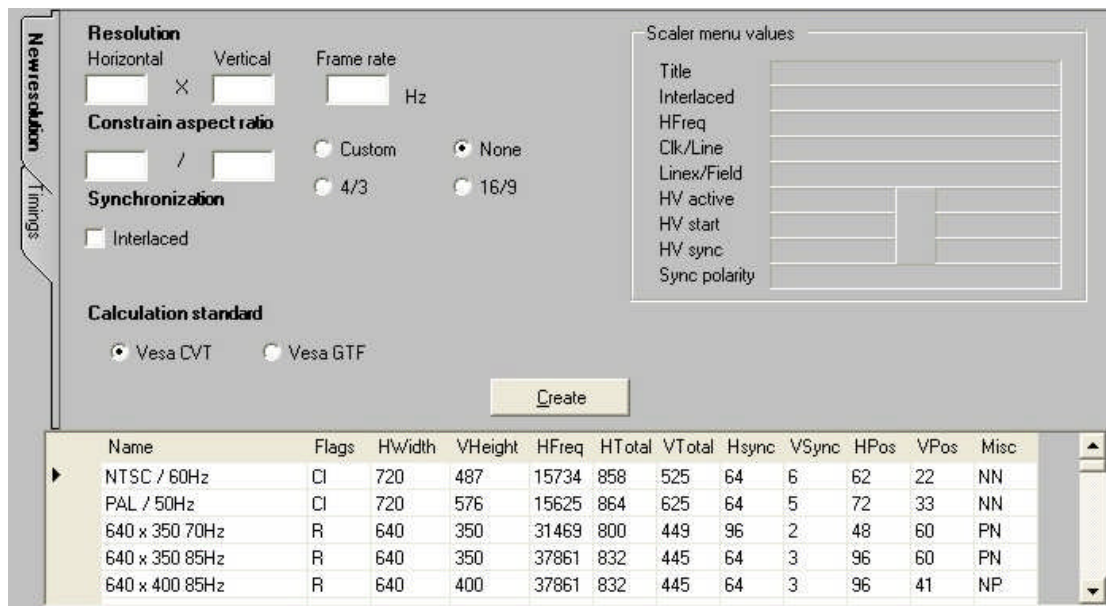

Figure 14 Resolution editor

C2-3300 SERIES OPERATION MANUAL

There are 2 ways to create a resolution using this tool. The easiest, shown on the New resolution tab at the side, allows you to create a new resolution using the minimum information of Horizontal and Vertical size and the desired refresh rate. It's also possible to constrain the Vertical size of the resolution by selecting a custom, 4:3 or 16/9 aspect ratio and then left clicking your mouse on the Vertical Resolution box which will then automatically calculate the Vertical Resolution for the given Horizontal Resolution and Aspect Ratio.

Once you have entered the required information it's simply a matter of pressing the 'Create' button. The resolutions are created using one of two VESA® standards, Coordinated Video Timings (CVT) or Generalized Timing Formula (GTF) in order to make the created resolutions as compatible as possible with standard video equipment. If you find your created resolution does not work effectively try the calculation using GTF.

Once you press the Create, you're asked if you want to add this new entry to the resolution table. If you select No, the resolution can only be added to the table using the Advanced Create and edit screen.

Once the new resolution is created the 'Scaler menu values' frame will show what the unit's on-screen values would be if you were in the 'Adjust Image Parameters' screen.

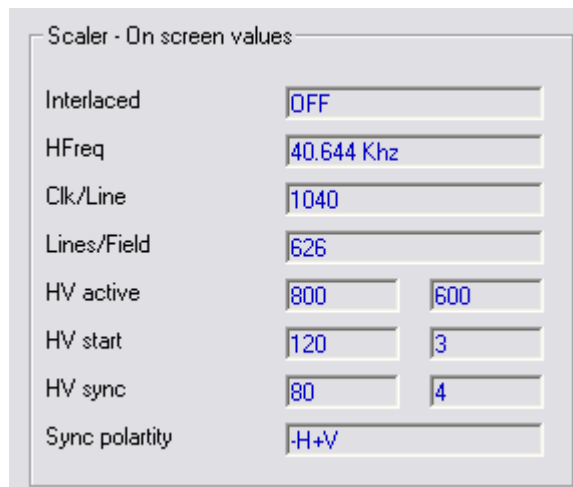

The image shows a dialog box titled "Scaler - On screen values". It contains several input fields for video timing parameters:

Parameter	Value
Interlaced	OFF
HFreq	40.644 Khz
Clk/Line	1040
Lines/Field	626
HV active	800 600
HV start	120 3
HV sync	80 4
Sync polarity	-H+V

Figure 15 Resolution editor - Unit on screen values

If the resolution was added to the resolution table, then the table at the bottom of the screen will update and show the newly created resolution and all its timing parameters. New resolutions are named using the resolution H and V size; refresh rate and the letter U to signify a user created resolution. Using the Timings tab you can alter this text.

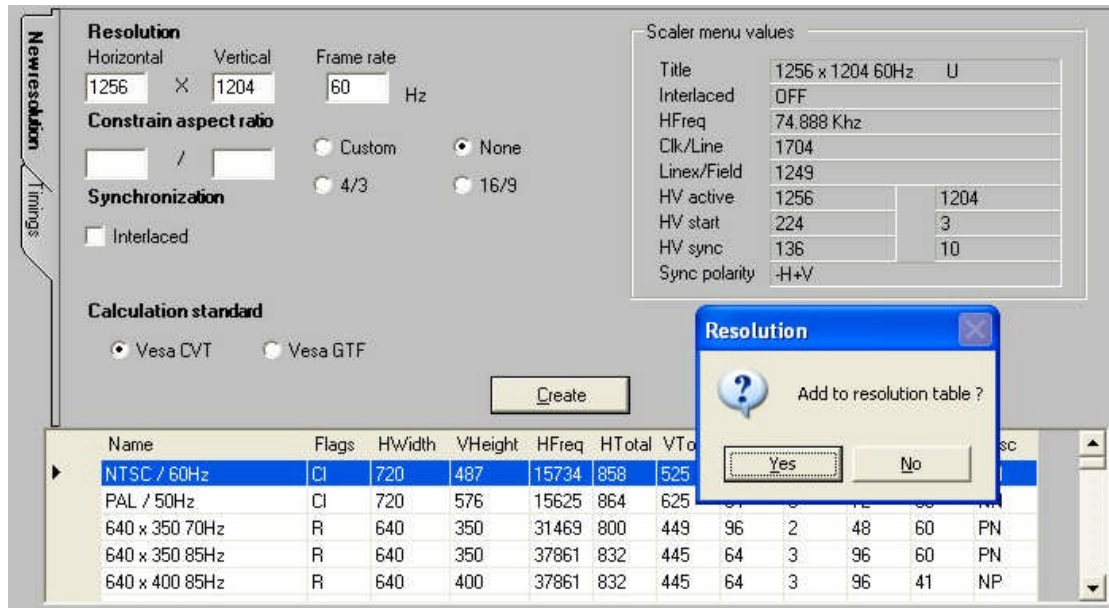

Figure 16 Add resolution to table

Once your new resolution is added, you can program the resolution into the Scaler using the **Communications** menu and then selecting **Program into unit** and then selecting **Program Resolutions**. The application will proceed to program all the resolutions on the list into the scaler.

Note that this will overwrite any resolutions currently in the scaler.

The second method of creating a resolution requires you to know all the detailed timing parameters. The timings tab allows all the detailed video timing information to be added and altered, including the title of the resolution entry (limited to 24 characters).

There are also along side the detailed timing parameters several flags that are used to specify the signal type these are interlaced – for interlaced video signals, CCIR for video that would normally be output on CV or YC connectors and RGB for video that would be output on RGB or Component type connections.

C2-3300 SERIES OPERATION MANUAL

Name	Flags	HWidth	VHeight	HFreq	HTotal	VTotat	Hsync	VSync	HPos	VPos	Misc
NTSC / 60Hz	CI	720	487	15734	858	525	64	6	62	22	NN
PAL / 50Hz	CI	720	576	15625	864	625	64	5	72	33	NN
640 x 350 70Hz	R	640	350	31469	800	449	96	2	48	60	PN
640 x 350 85Hz	R	640	350	37861	832	445	64	3	96	60	PN
640 x 400 85Hz	R	640	400	37861	832	445	64	3	96	41	NP

Figure 17 Resolution editor - advanced timings

In order to modify an existing resolution simply click on the resolution table at the bottom of the screen and its parameters will be editable within the Timings tab. Once the edits are complete click on Update to modify the settings for the selected resolution or Create New to keep the selected resolution and create a new resolution with modified parameters.

15 TROUBLESHOOTING AND TECHNICAL SUPPORT

If problems are experienced, please read through the symptom topics below in order to resolve the problem. After doing so, if you still need to, contact Technical Support at <http://www.tvone.com/support>. Please have the following details of the problem handy:

Whether the problem happens only at specific times or has only just started occurring (and what other things have changed at the same time).

Firmware revision numbers - found in the first item of the System menu:

If the problem relates to a specific source or resolution:

15.1 There is no picture on the Output.

If no LEDs are on, then ensure that the AC power adaptor is connected properly and the power switch is on at the AC outlet.

If the Standby/ON LED on the unit is off but another blue LED is active then check that the monitor output from the computer is connected at both the computer and the unit. Check that the output connector you are using from the unit is also connected at the unit and the display equipment.

Check that the display video equipment is set to the correct line input and format/standard as appropriate.

Check that the device connected to the output is on and can support the resolution set in the Adjust output menu, ensuring that the Sync type e.g. RGBHV, is also set correctly.

15.2 The image is shifted and not fully viewable

There are several ways to correct this, depending on the actual problem, although it's generally best to perform a Factory reset.

Try an AUTASET if the input is RGB or YUV/YCbCr. Next adjust the TL pos. adj. values in the Setup Program source menu until the incoming video signal is displayed correctly. You may also need to adjust the BR size adj. setting to ensure the incoming video signal is properly displayed.

15.3 The output resolutions no longer appear as expected.

Because any changes made in the Adjust resolutions menu are automatically stored, it may be that the resolution data has become altered or corrupted beyond the ability of a display to show it.

Either manually correct the resolution data, or restore the data to full factory conditions by doing a firmware update. The user should avoid altering the resolution parameter data unless absolutely necessary.

15.4 There is excessive flicker on the Output.

Try using a different Flicker reduction mode. Turning the contrast down and the brightness up on the output device can have a large effect on flicker. Or try adjusting the brightness and contrast of the source input by selecting the Input adjust menu.

15.5 The Output image is distorted.

This may occur where some of the areas of the image are very dark and others are very bright. The solution is to adjust the contrast and brightness settings on your Output device to rectify the problem.

Alternatively, if the Adjust resolutions menu has been used to the output resolution in question, a firmware update is recommended to perform a FULL factory reset.

15.6 Some colors appear to be incorrect on the CV/YC output

First try altering the color, contrast and brightness settings on your TV or video display. These are usually set up for a very different reason than viewing computer graphics and may need changing to suit. If you cannot achieve exactly what you desire then alter the inputs levels in Adjust sources until the correct colors are restored.

15.7 How can I reduce color smearing on CV connections?

Smearing usually occurs on Composite Video connections and is generally unavoidable - unless you can switch to using S-Video or RGB / YUV connections. It occurs because the brightness and color information is transmitted as one combined (composite) signal and the two parts have to be 'bandwidth-limited' to avoid them interfering with each other – which then reduces the quality.

15.8 I can no longer adjust the Output image resolution.

When the unit is in Lock mode, the output resolution is fixed to be the same as the Lock source input resolution. During this time the Output image menu item is not displayed.

15.9 The picture on the video display is black and white.

Ensure that all the cables are correctly connected. If you are using a PAL TV to display the output then the unit may be providing resolution set to NTSC mode, or vice versa.

15.10 The picture on the video display is green.

The Output type is probably incorrectly set to YUV mode, whereas you are connecting to an RGB monitor – see Adjust outputs menu.

15.11 The RGB input is selected but the image is rolling or pink.

Check the Adjust sources menu and confirm that the input type and sync method is set correctly. (Having YUV input selected, instead of RGBHV often causes this problem).

15.12 The video signal from my DVD player does not appear to work.

Some DVD players have a switch at the back that selects between 'Component' and 'S-Video' output, because most will not let you output both at the same time. Make sure it is in the right position for the output you want.

15.13 The output from the 1T-CT-464 is blue.

Please swap the Pb and Y connectors on the 1T-CT-464 so that the Y of the screen connects to Pb on the receiver and Pb on the screen connects to the Y of the receiver.

15.14 No video present from the UTP output.

Ensure that the receiver connected is supported, adjust the gain and offset adjustments to be minimum levels and ensure that a straight through UTP cable of at least Category 5 rating is being used.

The UTP output is not compatible with Ethernet network Hub's and Switches.

16 RETURN PROCEDURE

Before returning your unit for repair, there are several checks you can make yourself to make sure the problem is actually caused by a failure.

16.1 Are you sure there's a fault?

Many 'faults' are due to incorrect set-up or use so a simple checklist is provided below to help you identify potential problems.

Set the unit up with your equipment as described in this manual and run through the checklist. This will hopefully determine whether or not the unit is actually faulty and prevent units from being returned unnecessarily.

Check the Troubleshooting tips of this manual and check out the various FAQ (Frequently Asked Questions) listings on the support website, <http://www.tvone.com/support>, which shows the latest Hints, Tips and Solutions.

Don't presume it is the unit that is causing the problem. Check that the equipment being used with it is fully working and setup correctly – bypass the unit if possible by connecting the video source directly to the video display.

Check the AC power. Is it present and is the unit turned on? Check that all cables are properly plugged in and are not damaged and then make certain that all equipment connected to the unit is working properly.

Perhaps you have a "frozen" unit and you cannot change an input nor exit from the current task. In that case, a simple 'Factory Reset' of the product may sort the problem out. See earlier section on Front panel buttons to do this. Note that all user-settings will be lost following an engineering reset.

It is also worth ensuring that the latest firmware is installed in the unit – although, again, user settings are lost during a firmware update.

16.2 To return a unit for repair

First contact TV One using the <http://www.tvone.com/support> website. Support personnel will determine whether a return to the factory is the appropriate solution. If that's the case, a Return Authorization Number will be issued. You should provide the following information for each unit:

Product type

Serial number of the faulty unit (this is on the underside of the unit)

Full details of fault

Invoice number (if available)

Units should be returned via insured carrier or registered mail (thus allowing a trace to be made if the Processor is lost in transit), with shipping costs and insurance arranged at your own risk and expense. Goods in transit are the responsibility of the sender and the supplier will not be responsible for transit losses.

C2-3300 SERIES OPERATION MANUAL

Please clearly state the return number on the outside packaging and on any accompanying documentation. This will greatly speed up processing.

IMPORTANT: DO NOT return a unit for warranty repair without first obtaining a Return Authorization Number. No action will be taken on a unit returned in warranty for repair without a Return Authorization Number.

17 WARRANTY POLICY

LIMITED WARRANTY – With the exceptions noted in the next paragraph, TV One warrants the original purchaser that the equipment it manufactures or sells will be free from defects in materials and workmanship for a period of two years from the date of purchase. Should this product, in TV One's opinion, prove defective within this warranty period, TV One, at its option, will repair or replace this product without charge. Any defective parts replaced become the property of TV One. This warranty does not apply to those products which have been damaged due to accident, unauthorized alterations, improper repair, modifications, inadequate maintenance and care, or use in any manner for which the product was not originally intended.

Items integrated into TV One products that are made by other manufacturers, notably computer hard drives and liquid crystal display panels, are limited to the term of the warranty offered by the respective manufacturers. Such specific warranties are available upon request to TV One.

If repairs are necessary under this warranty policy, the original purchaser must obtain a Return Authorization Number from TV One and return the product to a location designated by TV One, freight prepaid. After repairs are complete, the product will be returned, freight prepaid.

LIMITATIONS - All products sold are "as is" and the above Limited Warranty is in lieu of all other warranties for this product, expressed or implied, and is strictly limited to two years from the date of purchase. TV One assumes no liability to distributors, resellers or end-users or any third parties for any loss of use, revenue or profit.

TV One makes no other representation of warranty as to fitness for the purpose or merchantability or otherwise in respect of any of the products sold. The liability of TV One with respect to any defective products will be limited to the repair or replacement of such products. In no event shall TV One be responsible or liable for any damage arising from the use of such defective products whether such damages be direct, indirect, consequential or otherwise, and whether such damages are incurred by the reseller, end-user or any third party.

18 CONNECTOR PINOUTS

18.1 DVI-I connector

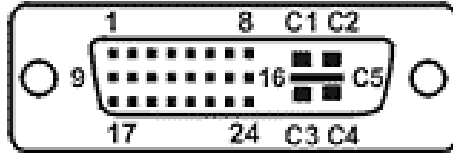

PIN#	SIGNAL	PIN#	SIGNAL
1	T.M.D.S DATA 2-	16	HOT PLUG DETECT
2	T.M.D.S DATA 2+	17	T.M.D.S DATA 0-
3	T.M.D.S DATA 2/4 SHIELD	18	T.M.D.S DATA 0+
4	Not used	19	T.M.D.S DATA 0/5 SHIELD
5	Not used	20	Not used
6	DDC CLOCK	21	Not used
7	DDC DATA	22	T.M.D.S CLOCK SHIELD
8	Not used	23	T.M.D.S CLOCK+
9	T.M.D.S DATA 1-	24	T.M.D.S CLOCK-
10	T.M.D.S DATA 1+		
11	T.M.D.S DATA 1/3 SHIELD	C1	Not Connected
12	Not used	C2	Not Connected
13	Not used	C3	Not Connected
14	+5V POWER	C4	Not Connected
15	GND	C5	GND

(DVI-D connectors do not have connections to pins C1 to C5 or pin 8.)

18.2 HD15 connector

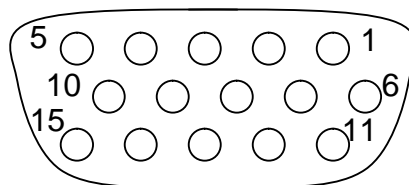

1. Red / Pr / V / Composite Video (CV)
2. Green / Y (including Y From YC Video)
3. Blue / Pb / U / C (From YC Video)
4. Not connected
5. GND
6. GND
7. GND
8. GND
9. No connection
10. GND
11. GND on input, pulled high on output (used for auto-termination)

12. Not Connected
13. H sync (or composite sync for RGBS)
14. V sync
15. Not Connected
(Note: EDID information is not supported).

18.3 RS232 / D9 socket

1. N/C
2. TX (Transmit data)
3. RX (Receive data)
4. N/C
5. GND (Signal return)
6. N/C
7. CTS (Clear to send)
8. RTS (Request to send)
9. N/C

18.4 4 Pin mini-DIN S-video connector (YC) input

1. Y (Luminance)
2. GND
3. GND
4. C (Chrominance)

18.5 Multi-way audio connector (balanced)

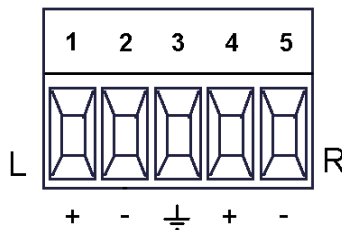

1. Left positive signal (hot)
2. Left negative signal (cold)
3. Signal ground (shared with left and right)
4. Right positive signal (hot)
5. Right negative signal (cold)

19 SPECIFICATIONS

See product front and rear diagrams for details of product I/O.

19.1 Universal Inputs

Analog RGB/YPbPr supporting RGBHV, RGBS, RGsB, YPbPr, auto-terminating into 75 Ohm

Digital sync (in RGBHV or RGBS mode): TTL Level, 10K termination, pos or negative

Analog sync (in RGsB, YPbPr, YUV modes): 0.3v negative.

Analog RGB Level Range: 0.5-2.0 Vp-p approx.

Scan Rate Detection: automatic

Analog PC Resolutions: any up to 2048x2048

Analog HDTV Resolutions: any up to 1080p

Analog max horizontal scan rate: 150kHz

Composite Video via adapter (or alternatively direct to pin 1 of HD15, GND to pin 6)

YC Video via adapter (or alternatively direct Y to pin 2, and C to pin 3 of HD15, associated GNDs to pins 7 and 8)

EDID is not supported on this model series.

19.2 Universal Outputs

Program:

DVI-D output on DVI-I connector, supporting up to 108MHz maximum clock/pixel rate (1280x1024 @ 60Hz) – higher pixel rates are sub-sampled to 108MHz.

Program:

Analog output impedance 75 Ohm

Analog RGBHV, RGBS, RGsB, YPbPr (0.7v RGB / 1.0v sync-tip to white, approx. 0.4v DC offset)

Connectors: HD-15

Analog PC Resolutions: any up to 2048x2048 (user adjustable)

Analog HDTV Resolutions: any up to 1080p

Vertical Refresh Rate: any to 250Hz

Composite Video via adapter (or alternatively direct from pin 1 of HD15, GND to pin 6)

YC Video via adapter (or alternatively direct Y from pin 2, and C pin 3 of HD15, associated GNDs pins 7 and 8)

Preview:

Analog output impedance 75 Ohm

Analog RGBHV

Analog PC Resolutions: any up to 2048x2048 (user adjustable)

19.3 Audio input/output (C2-3310 / C2-3360 only)

Inputs: 8 x balanced / unbalanced stereo via screw terminals
Output: 2 x balanced / unbalanced stereo via screw terminals
Full Program / Preview switching with fading.
Audio-follow-video or Audio break-away (user selectable)

19.4 Locking/Mixing (C2-3350 / C2-3360 only)

CV/YC SC/H phase adjustments: +/- 180 degrees
Keyer: chromakey (YUV) or lumakey (Y)
Mixer: PC / Video, foreground/background swappable
PIP: variable window size & position – single-button enabling
Unrestricted – any input over any other (Lock source determines video output resolution).

19.5 Scaling / sampling / memory

Size and position: automatic via AutoSet or Manual
Image size: user-definable presets
Image freeze: one video frame
Settings memory: non-Volatile
Zoom range: variable to 10x Zoom (1000%)
Shrink range: variable to 10%
Image mirroring: Horizontal and/or Vertical
Horizontal filtering: full digital
Conversion technology: proprietary
Color resolution: 24-bit (16.8 Million Colors)
Sampling rate: 108MHz maximum
Digital sampling: 24-bit, 4:4:4 format
Firmware memory: flash, upgradeable via RS-232

19.6 Warranty

See warranty policy for further details..

19.7 Regulatory Compliance

Main unit conforms to FCC, CE, RoHS

19.8 Environmental

Operating Temperature 0° to +45° C (+32° to +113° F)
Operating Humidity 10% to 85%, Non-condensing
Storage Temperature -10° to +70° C (+14° to +158° F)
Storage Humidity 10% to 85%, Non-condensing

19.9 Power Requirement

Mains supply: 100-240V ac (47-63 Hz).

Power consumption ~20W (but varies between units).

Internal over-voltage & over-current protection.

19.10 Control Methods

The unit can be controlled locally via the front panel buttons, multi-directional switch and Liquid Crystal Display. It can also be controlled remotely via the RS-232 interface using a D9 female connector or again remotely using Ethernet via a RJ45 Ethernet connector, or using an Infrared remote using the IRC-4 remote unit.

19.11 Accessories Included

2x composite and 1x YC (S-Video) adapters are supplied with each model.

19.12 Mechanical

Size (H x W x D): 1.725" x 17" x 7.92" (44 x 431 x 201mm)

Weight (Net): 7.0 lbs (3.2 kg)

19.13 Optional Accessories

Additional composite and YC (S-Video) adapters can be purchased as accessory items from TV One.

TV One part numbers:

ZCH3000-1 Composite Video to HD15 adapter

ZSH3000-1 YC Video to HD15 adapter

RM-110 Rear-rack support rails

20 CONTACT INFORMATION

Should you have any questions or require assistance with this product in areas not covered by this manual, please contact TV One at the appropriate location shown below:

TV One USA

2791 Circleport Drive
Erlanger, KY 41018
USA
Tel 859-282-7303
Fax 859-282-8225
sales@tvone.com
www.tvone.com

TV One Europe

Continental Approach
Westwood Industrial Estate
Margate, Kent CT9 4JG, UK
Tel +44 (0)1843 873311
Fax +44 (0)1843 873312
sales.europe@tvone.com
www.tvone.eu

TV One Asia

11F, No. 28, Sec. 2
San-Min Road, Panchiao City
Taipei Hsien 220
Taiwan ROC
Tel +886 2 8951-0674
Fax +886 2 8951-0675
sales.asia@tvone.com
www.tvoneasia.com

TV One China

Room 1007, Golden Peach Building
No.1900 Shangcheng Road
Pudong, Shanghai,
China 200120
Tel +86 21 5830-2960
Fax +86 21 5851-7949
sales.china@tvone.com
www.tvonechina.com

TV One Latin America

6991 NW 82 Ave # 8
Miami, FL 33166
USA
Tel 305-396-6275
Fax 305-418-9306
sales.latinoamerica@tvone.com
www.tvonela.com

TV One Mercosur

Honduras 5849 2nd Floor Office C
(C1414BNI) Capital Federal
Buenos Aires, Argentina
Tel +54 11 4771-5570
Fax +54 11 4771-5570
sales.latinoamerica@tvone.com
www.tvonela.com