

Mixing Console  
PMX124

AUDAC

PROFESSIONAL AUDIO EQUIPMENT

---

PMX124 12 Channel mixing console



# User Manual & Installation Guide

AUDAC PROFESSIONAL AUDIO EQUIPMENT

# User Manual & Installation Guide

---

© AUDAC  
<http://www.audac.eu>  
[info@audac.eu](mailto:info@audac.eu)

---

# Index

<b>INTRODUCTION</b> .....	<b>3</b>
<b>ENVIRONMENT</b> .....	<b>4</b>
<b>SAFETY REQUIREMENTS</b> .....	<b>5</b>
CAUTION – SERVICING .....	5
<b>FRONT PANEL CONTROLS</b> .....	<b>6</b>
CHANNEL CONTROL SECTION .....	6
MAIN CONTROL SECTION .....	8
<b>CONNECTIONS AND CONNECTORS</b> .....	<b>11</b>
FRONT PANEL CONNECTIONS .....	11
REAR PANEL CONNECTIONS .....	14
POINTS TO REMEMBER .....	15
CONNECTIONS .....	15
<b>APPLICATIONS</b> .....	<b>17</b>
SETUP PROCEDURE .....	17
HOME RECORDING .....	18
LIVE PERFORMANCE .....	19
<b>BLOCK DIAGRAM</b> .....	<b>20</b>
<b>ADDITIONAL INFORMATION</b> .....	<b>21</b>
TECHNICAL SPECIFICATIONS .....	21
<b>PERSONAL NOTES</b> .....	<b>23</b>

## Introduction

*This section briefly describes the possibilities of the PMX124 Mixing Console.*

**T**he PMX124 Mixing Console was developed as an easy to use, flexible solution for multifunctional use.

During the development of the PMX124, the AUDAC-engineers wanted to achieve four goals:

- Delivering a flexible audio solution to control multiple functions
- Easy to use
- Excellent sound quality
- Modern and advanced design

The AUDAC PMX124 is a 12 channel premium, high-headroom, easy to use analog mixer. It is designed as a versatile mixer with all the necessary controls and connections to be applied in a wide variation of applications, ranging from rehearsal rooms to home studio's and even on stage use. It has a modern design with various connection possibilities for all kinds of microphones and music sources, while guaranteeing an excellent sound quality .

The mixer has also a built-in 24-bit DSP with 100 presets, including effects such as Chorus, Flange, Delay, ... and many others, allowing each mix or vocal to be tuned as desired. In addition to this, all connections and controls required for connecting external effect modules are also provided.

Main features:

- 4 Mono & 4 Stereo channels input
- Stereo Main output & ALT 3/4 output.
- AUX Return and 2 x AUX Send
- 3 Band Equalizer
- PFL function for all channels
- 24bit DSP effect 100 presets, EFX on/off & EFX level
- Tape with PFL switch, Headphone / Control Room
- Foot switch connection
- Phantom Power (+48V)
- 19" Brackets included

## Environment

**Do not place this unit in an enclosed environment such as a bookshelf or closet. Ensure that there is adequate ventilation to cool the unit.**

**Do not place the unit in environments which contain high levels of dust, heat, moisture or vibration.**

**Do not use the unit near water or other liquids. Make sure no water or other liquids can be spilled, dripped or splashed on the unit.**

**This unit was developed for indoor use only. Do not use it outdoors.**

**Do not place objects on top of the unit.**

**Place the unit on a stable base or mount it in a stable 19" rack.**

## Safety Requirements

**Always handle the unit with care.**

**Only use a grounded socket outlet and a power cord with grounding plug to plug in the unit.**

**This unit is not a toy. It should not be operated by children.**

**Do not stick objects through ventilation openings.**

**Do not open the unit (risk for electrical shock).**



### CAUTION – SERVICING

This unit contains no user serviceable parts. Refer all servicing to qualified service personnel. Do not perform any servicing unless you are qualified to do so.

### Note

This product conforms to the following European Standards: EN 50081-1: 1992, EN 50082-1: 1992, EN 60065: 19

## Front Panel Controls Channel Control Section

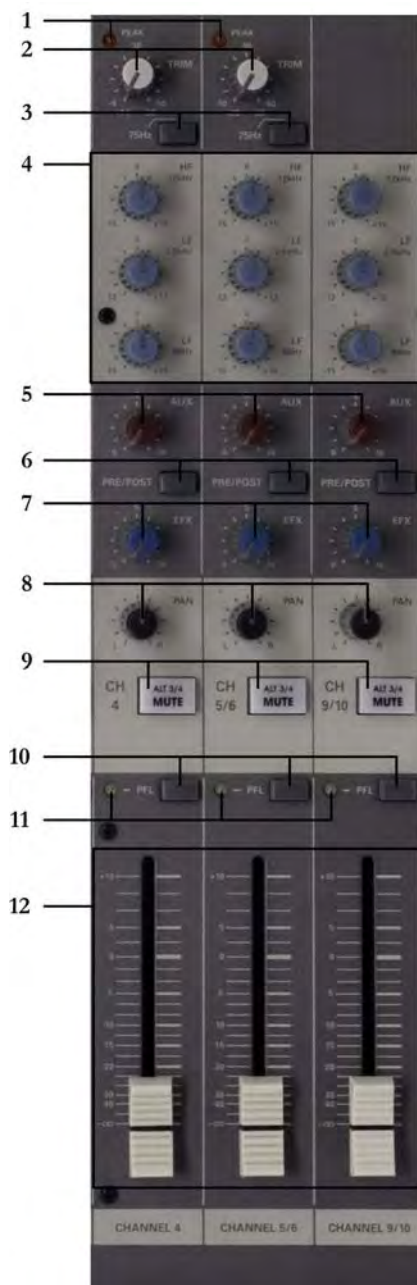

### 1. Peak LED indicator:

These LED indicators light-up when the level of the input signal reaches 5 dB below the channel's clipping point. It shows the level of the POST-EQ /PRE fader signal. When it lights up frequently, the 'Trim Control' potentiometer has to be used to decrease the input sensitivity of the channel. When this causes no improvement, the output level of the connected source has to be reduced.

### 2. Trim Control:

With this button, the level of the input signal can be adjusted to an appropriate level. The best signal/noise and dynamic range balance will be reached when you adjust the 'Trim Control' so that the 'Peak LED indicator' lights-up occasionally. The input sensitivity of a Mic channel can be set between -50 dB and -6 dB, the input sensitivity of a Line input can be set between -30 dB and +14dB and the sensitivity for a Mono/Stereo combination channel can be set between -20 dB and +20 dB.

### 3. HPF (High Pass Filter):

This switch toggles the HPF ON and OFF. To turn the HPF on, make sure the button is pushed-in. The HPF cuts frequencies below 75Hz.

### 4. 3-Band equalizer controls:

This is a 3-band equalizer whose center frequencies, range and type are shown in the table below. The frequency response is flat when the knob is set in the '0' position.

CONTROL	MAX BOOST/CUT	FREQUENCY	TYPE
HIGH	±15dB	12kHz	Shelving
MID	±12dB	2.5kHz	Peaking
LOW	±15dB	80Hz	Shelving

**5. Aux controls:**

The Aux knobs controls the level of the signals that are sent to the Aux bus.

**6. PRE / POST switch:**

This button determines whether the AUX signal is Pre Fader (signal level is not influenced by fader position) or Post fader (signal level is influenced by fader position).

**7. EFX controls:**

These knobs control the level of the signals sent to EFX bus. The signals mixed by this bus are sent to the EFX SEND jack located on the front, and the overall level of this bus can be set by the 'Master AFX Send Control'. Because of the control that is placed after the channel fader, the signal level will be influenced by the channel's fader setting.

**NOTE:** *The EFX bus signal is also fed into the internal digital signal processor (DSP).*

**8. PAN / Balance control:**

- **PAN (Mono Channel):** This control pans the channel signal across the master L and R outputs, therefore determining the ideal position of the sound from that channel. When the PAN control is set all the way to the left, the sound from that channel will only be heard from the left speaker. Same situation for the control being set all the way to the right. When this control is set in intermediate position, the sound will be played at both channels in a stereo sound application.

- **BALANCE (Stereo Channel):** This control adjusts the balance or the L/R position of the stereo input signal. Turning the BALANCE control to the left of center moves the source signal towards the MAIN MIX L bus, turning it to the right moves the source towards the MAIN MIX R bus.

**9. Mute / ALT 3-4 switch:**

When the 'Mute / ALT3/4' button is deactivated (depressed) the channel output will be sent to the 'ALT3/4' output and not to the 'MAIN L/R' output. The 'ALT3/4' bus gives you a second independent stereo sub mix with its own sub master stereo fader.

**10. PFL switch:**

This button allows you to monitor the 'Pre Fader Level' input signal through a 'Headphone' or the 'Control Room Outputs'. When the button is NOT pressed the channel signal will be sent to the PFL bus.

**11. PFL indicator:**

This indicator lights-up when the PFL switch is turned on.

**12. Channel fader:**

These faders are the main level control for the corresponding channels. It determines the level of the signal that is sent from the channel to the master mixing and effect busses. The settings of the faders determine the mix, balance and sound levels between the instruments or other sources connected to the inputs. When a channel is not used, it's fader should be set at the minimum position to prevent the addition of unwanted noise in the main program signal.



## Main Control Section

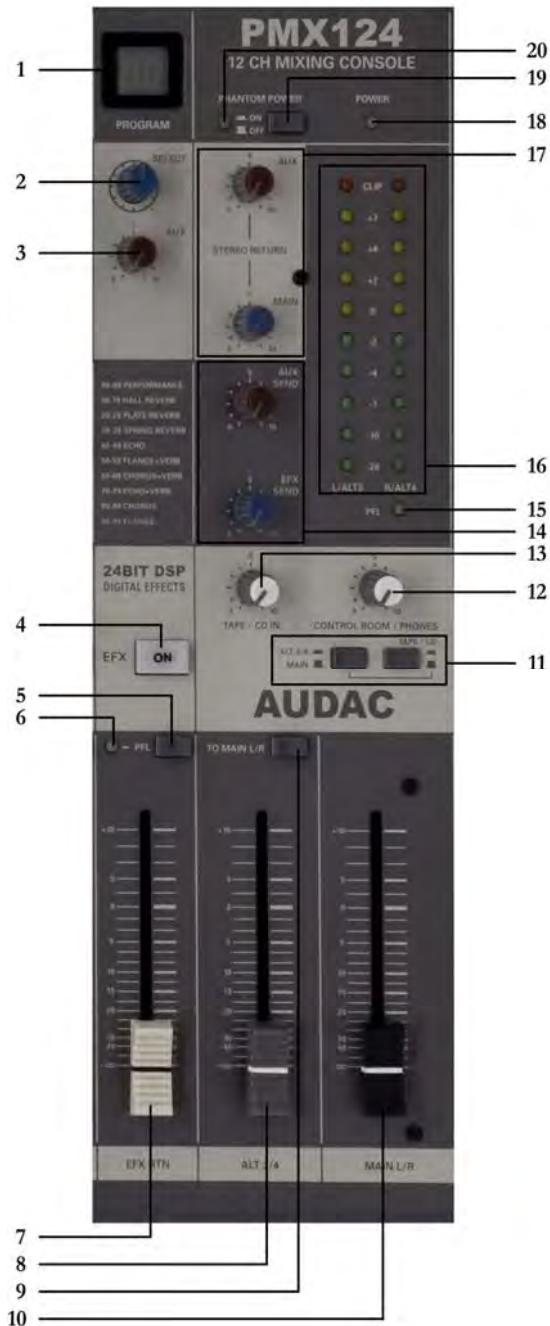

1. **DSP program display:**  
This display shows the program number of the selected effects program.
2. **DSP program select switch:**  
This program knob allows you to select one of the 100 digital effects of the built-in 24 bit, high quality, digital signal processor. Some of these effects are Delay, Chorus and Reverb.
3. **AUX PRE control:**  
Use this control to adjust the signal level that is sent from the internal digital effect to the AUX bus.
4. **DSP ON/OFF switch:**  
This switch allows you to turn the internal digital effect ON and OFF.
5. **PFL switch:**  
Pushing this button 'in' will send the effect signal to the PFL bus.
6. **PFL indicator:**  
This indicator lights-up when the PFL switch is turned on.
7. **EFX RTN fader:**  
With this fader, the signal level sent from the digital effect to the MAIN bus can be adjusted.
8. **ALT 3/4 output fader:**  
With this fader, you can adjust the final combined stereo signal level that is sent to the ALT 3/4 output jacks.
9. **To main switch:**  
When this button is pressed 'in', the mixer will send the signal from the 'ALT 3/4' to the 'MAIN L/R' outputs.

**10. Main L/R master fader:**

This fader adjusts the final signal level sent to the 'MAIN L/R' output.

**11. Level-Meter Signal Buttons:**

Use these buttons to determine the signal that is sent to the 'Control Room' and/or 'Headphone' outputs. The illustration below shows how the button settings correspond to the signal selection.

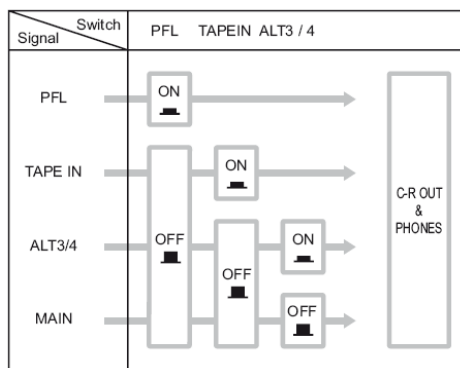

**12. Control room / Phones control:**

This knob controls the level of the signal that is sent to the 'Control Room' Jacks or the 'Headphone' Jack.

**13. Tape-IN control:**

This knob controls the level of the playback signal that is connected to the 'Tape-in' RCA Jacks.

**14. Master send:**

**- Master AUX Control:**

Use this control knob to adjust the signal level sent to the 'AUX' output jack.

**- Master EFX Control:**

Use this control knob to adjust the signal level from the 'Effect' bus sent to the 'Effect Output' Jack.

**15. PFL indicator:**

This indicator lights-up when the PFL switch is turned on.

**16. Output level meter:**

A vertical row of ten LED's continuously indicate the output level of the signal that is selected by the 'Level Meter Signal Buttons'. The 0 LED indicates an output level of +4 dB.

When the LED bar lights up red, the signal is coming close to clipping level.

**17. Stereo return control:**

**- AUX CONTROL:**

Use this control knob to adjust the level of the signal sent from the 'Return' Jack to the 'AUX' bus.

**- MAIN CONTROL:**

Use this control knob to adjust the level of the signal sent from the 'Return' Jack to the 'Main' bus.

**18. Power indicator:**

This indicator lights-up when the power switch is turned on.

**19. Phantom power switch:**

Use this switch to toggle the phantom power ON and OFF. When the switch is turned ON, the mixer supplies phantom power to all channels that contain XLR Mic input connectors. Turn this switch ON when using one or more condenser microphones, however the switch may be left on when connecting balanced dynamic microphones.

**NOTE:** *When this switch is on, the mixer supplies +48V DC power to pins 2 and 3 of all XLR-type 'Mic Input' connectors. We also recommend to turn all output controls to minimum settings before operating the switch, to avoid the risk of loud noises that could cause hearing loss or damage.*

**20. Phantom power indicator:**

This indicator lights-up when the phantom power switch is turned on.

## Connections and Connectors

### Front panel connections

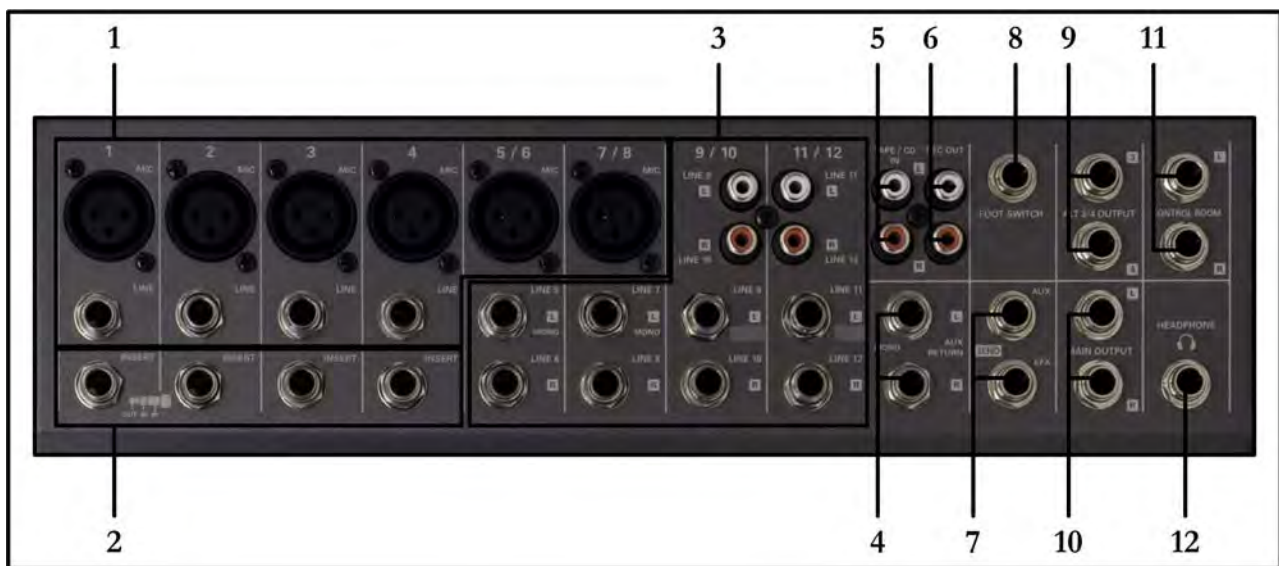

#### 1. Channel input jacks:

##### - MIC JACKS:

3-pin XLR connectors are used for the connection of balanced low impedance microphones.

##### - BALANCED LINE IN JACKS:

Standard 1/4" TRS (Tip, Ring, Sleeve) phone jacks are used for balanced or unbalanced line level signals. Some examples of line level equipment include most electronic keyboards, synthesizers, turntables (with appropriate preamps), tape decks and the line outputs from other mixers.

## 2. Channel insert I/O jack:

These are 1/4" TRS (Tip, Ring, Sleeve) phone Jacks which support bi-directional operation. These input/output jacks are located between the head-amplifier and the high pass filter. They can be used to connect these channels independently to your own graphic equalizers, compressors, noise filters, or other devices.

**NOTE:** Connection to an I/O Jack requires a special separately sold insertion cable. It is described in the illustration below.

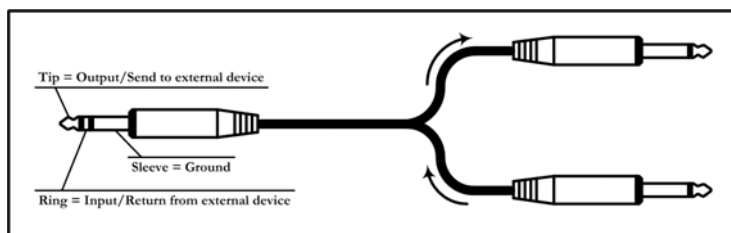

## 3. Channel input jacks:

These are unbalanced stereo line input jacks. There are two different types of jack's provided, phone type 1/4" TRS (Tip, Ring, Sleeve) Jacks and RCA pin type Jacks.

## 4. Stereo return L (mono), R jack:

These are unbalanced 1/4" TRS (Tip, Ring, Sleeve) phone-type line input jacks. The signal received by these jacks is sent to the 'MAIN' bus and 'AUX' bus. These jacks are typically used to receive a return signal from an external effect (reverb, delay, etc.).

**NOTE:** These jacks can also be used as an auxiliary stereo input. If you connect to the L (MONO) jack only, the mixer will recognize the signal as a mono signal and will propagate the identical signal on both L and R jacks.

## 5. Tape in jacks:

These RCA pin input jacks can be used to connect a stereo sound source. They are often used to connect a CD or DAT player for direct monitoring.

**NOTE:** You can adjust the signal level using the 'TAPE IN' control knob in the Master control section.

## 6. Rec out jacks:

At the 'REC OUT' connectors is the pre-fader signal from the master bus available to be connected with a recording device.

## 7. Send jacks:

### - AUX:

This is an unbalanced phone type output jack on which the output signal of the AUX bus is available. It can be used for connecting an effector, cue box or other monitoring system.

### - EFX:

This is an unbalanced phone type output jack on which the output signal of the EFX bus is available. It can be used for connecting an external effector.

## 8. Foot switch jack:

To this phone input jack, a foot switch can be connected. When a foot switch is connected, it can be used to toggle the digital effects ON and OFF.

**9. ALT 3/4 output jacks:**

These are unbalanced 1/4" phone type output jacks on which the output signal of the ALT 3/4 bus is available. These jacks can be used to connect to the input jack of an MTR, external mixer or other such device.

**10. Main L/R output jacks:**

On these jacks is the main stereo output signal available. These jacks can be used for connecting the power amplifier which is used to drive your main speaker system. This signal can also be used when recording the output signal influenced by the 'Main fader' level control in the 'Master Control' section. The connections are made by TRS (Tip, Ring, Sleeve) phone-type balanced output jacks.

**11. Control room output jacks:**

These stereo 1/4" phone-type output jacks can be used to send the mixed output signal to a monitoring system. Use the 'Control Room/Headphone Control' to adjust the output signal level.

**NOTE:** *The signal available on these jacks can be selected by the settings of the 'Main-ALT3/4' toggle switch, the 'Tape In' switch and the PFL switches on the input signals.*

**12. Phones jack:**

This is a stereo phone-type output jack which can be used for connecting Headphones to the mixing table.

**NOTE:** *The signal available on this connector can be selected by the settings of the 'Main-ALT3/4' toggle switch, the 'Tape In' switch and the PFL switches on the input signal.*

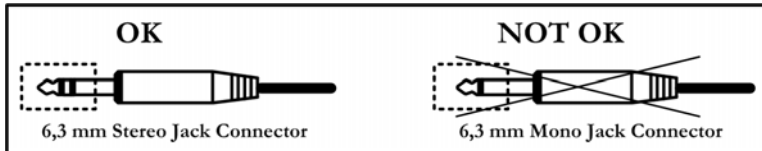

## Connections and Connectors

### Rear panel connections

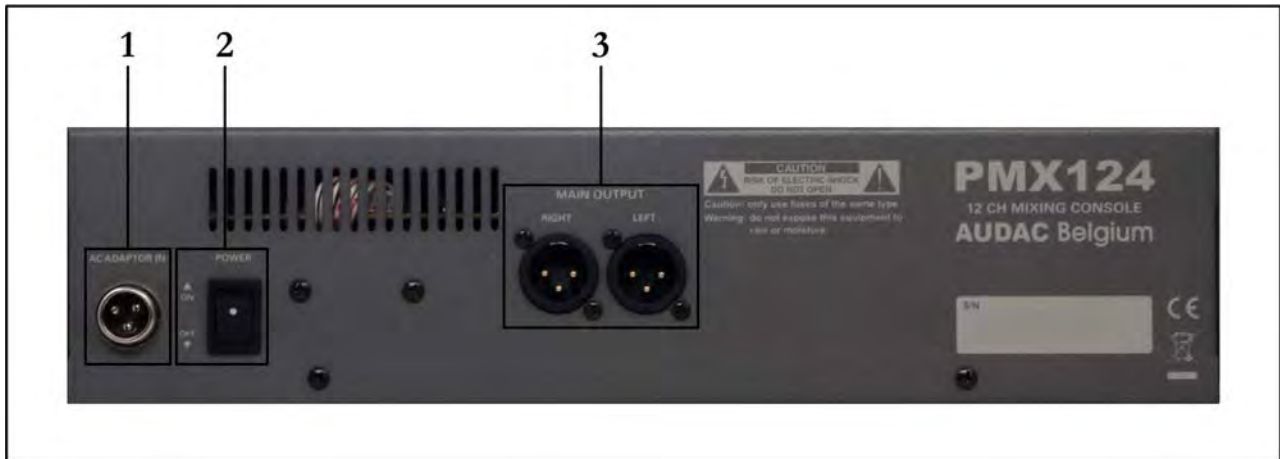

#### 1. AC adaptor in connector:

Connects to the included PA-M1224 power adaptor.

**NOTE:** Only use the original included PA-M1224 power adaptor. The use of a different power adaptor may cause damage to the appliance, or can even cause fire or electrical shocks.

#### 2. Power switch:

Use this switch to turn the mixer ON and OFF.

#### 3. Main balanced L/R output:

The main stereo output signal of the mixer is available on these 3-pin balanced XLR connectors. They can be used for connecting the main stereo output signal of the mixer to a power amplifier with balanced signal inputs, which is used to drive your main speaker system.

## Points to remember

- In all cases, always use high quality twin screened audio cable. Check for instability at the output.
- Always connect both conductors at both ends, and make sure that the shield is connected only at one end.
- Don't disconnect the mains earth from each piece of equipment. This is needed to provide both safety and screen returns to the system star point.
- Equipment which has balanced in- and outputs may need to be electrically isolated from the equipment rack and/or other equipment, to avoid earth loops.

It is important to remember that all equipment which is connected to the mains, is a potential source of hum and interference and may radiate both electrostatic and electromagnetic radiation. In addition, the mains will also act as a carrier for many forms of RF interference generated by electric motors, air-conditioning units, light dimmers, etc. Unless the earth system is clean, all attempts to improve hum noise levels will be ineffective. In extreme cases there will be no alternative but to provide a completely separate and independent 'technical earth' to replace the incoming 'noisy earth'. However, always consult your local electricity supply authority to ensure that safety regulations are not being infringed.

## Connections

The in- and output connections of AUDAC audio equipment are performed corresponding to international wiring standards for professional audio equipment.

Balanced XLR connectors are wired as described:

- Pin #1: Shield
- Pin #2: Positive
- Pin #3: Negative

Balanced 1/4" TRS (Jack) connectors are wired as described:

- Tip: Positive
- Ring: Negative
- Sleeve: Shield

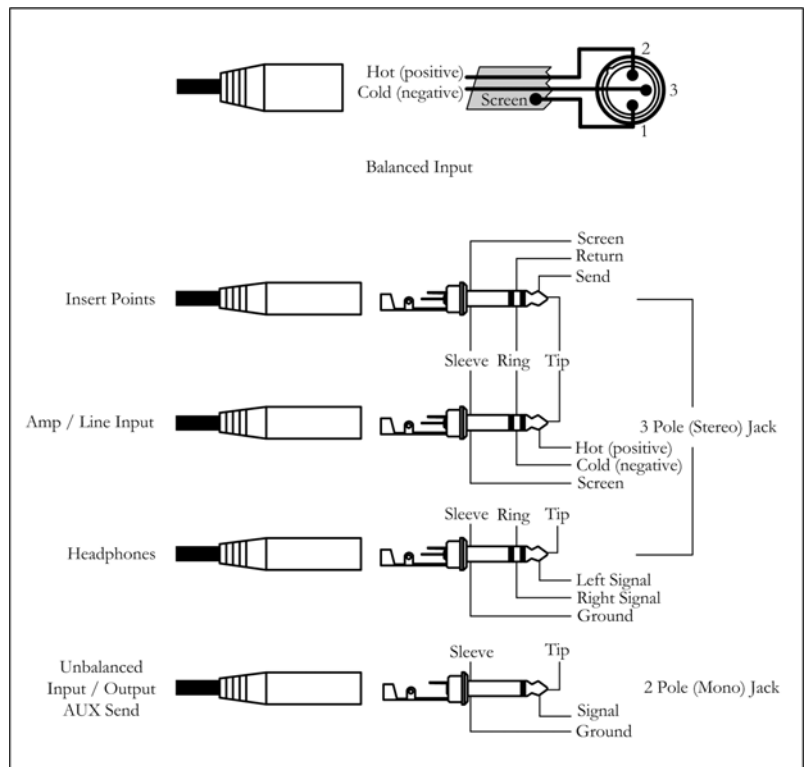



REMOTE DEVICE DESCRIPTION	CABLE	REMOTE SIDE OF CABLE (TYPE OF CONNECTOR)
A. XLR		XLR male
Floating or Balanced low impedance : most professional line in and line out equipment, microphones.		
B. TRS PHONE		XLR male
C. STANDARD PHONE		XLR male
Unbalanced low impedance : some professional equipment and microphones		
D. STANDARD PHONE		XLR male
Unbalanced high impedance : most HiFi equipment		
E. SHIELD/GND PHONE		6,3mm Mono Jack
Unbalanced high impedance : most HiFi equipment		

## Applications

### Setup procedure

1. Before connecting the microphones and instruments, be sure that all devices are turned off. Also be sure that all of the mixer's channel faders and master control faders are set all the way down.
2. For each connection, connect one end of the cable to the relevant microphone or instrument, and connect the other end to the appropriate input jack on the mixer.

**NOTE:** *Where an input channel contains both a 'Mic Input' and a 'Line Input' jack, you may use either one of these jack's but don't use both at the same time.*

3. To avoid damage to the speakers, power-up the devices in the following order:  
Peripheral devices → Mixer → Power amps (or powered speakers).

**NOTE:** *When shutting the system down, turn off the power in the opposite order:  
Power amps (or powered speakers) → Mixer → Peripheral devices.*

# Home Recording

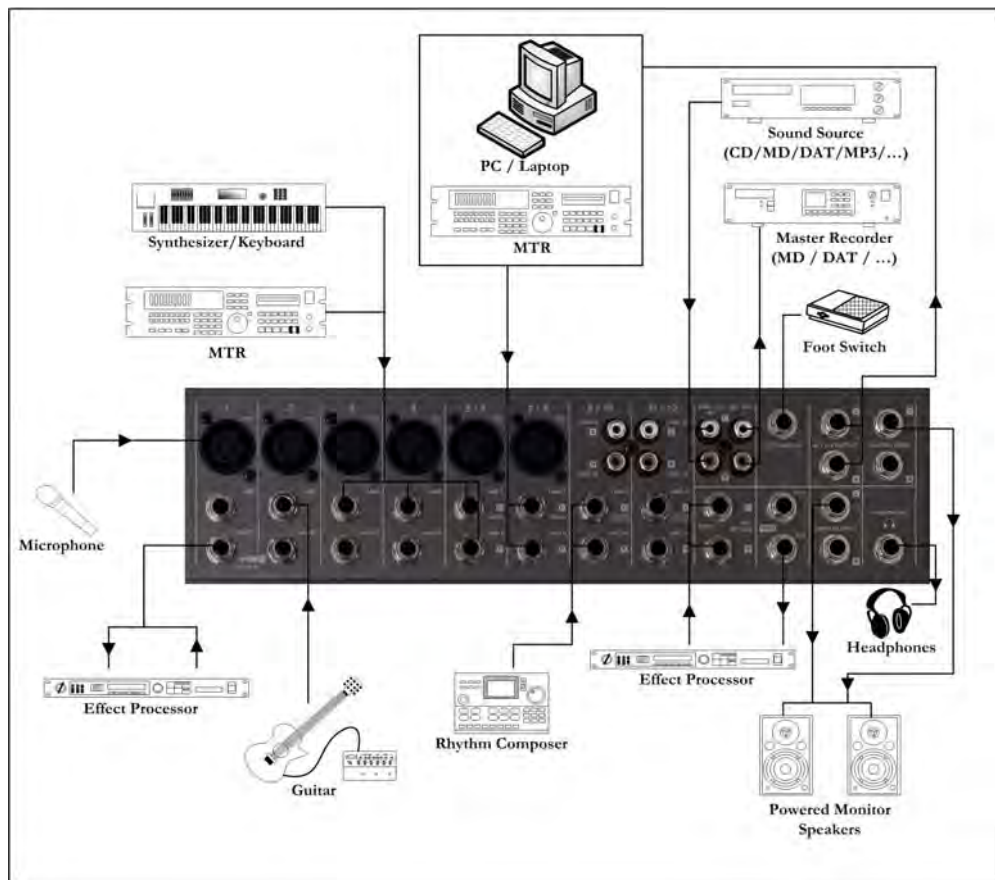

# Live Performance

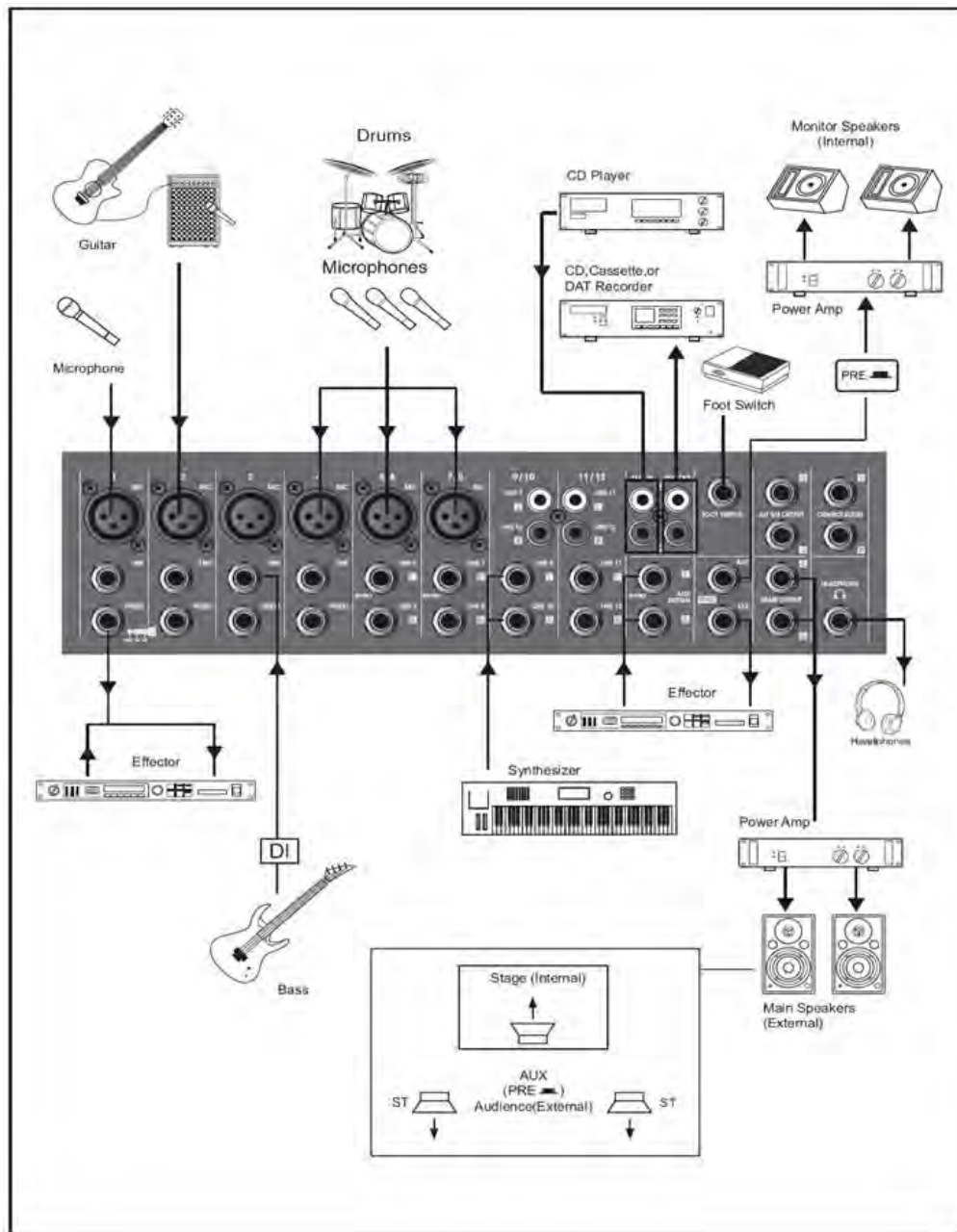

Block Diagram

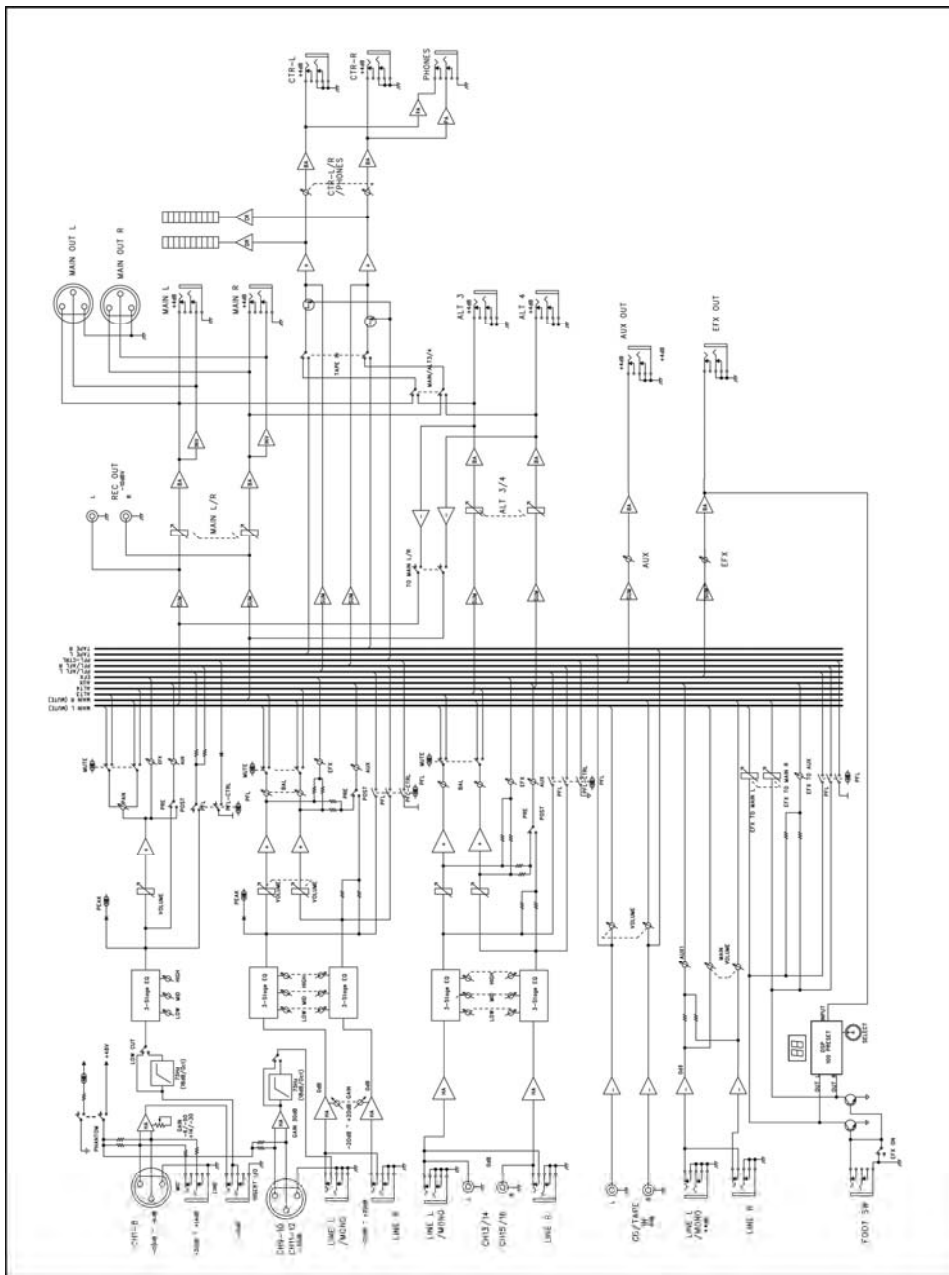

## Additional Information PMX124

## Technical specifications

0 dB = 0.0775 Vrms, 0 dBV = 1 Vrms

Maximum Output Level (0.5% T.H.D. at 1kHz)	+26 dB (Main L/R), +20 dB (ALT 3/4, Aux/EFX & Control Room) +20 dB (Insert), More than 100 mW (Headphones) @ 33 Ohm	
Frequency Response	20 Hz – 20 kHz, +1/+2 dB (Mix L/R, ALT 3/4, Aux/EFX Send & Control Room)	
Hum and Noise (Average RS = 150 Ohm)	-127 dB equivalent noise input, -95 dB residual noise (MIX L/R, ALT 3/4, Aux/EFX SEND, Control Room out) -88 dB (MIX L/R, ALT 3/4, Aux/EFX SEND, Control Room out)	
T.H.D. (Total Harmonic Distortion)	< 0.1% @ +14 dB, 20 Hz – 20 kHz (Mix L/R, ALT 3/4, Aux/EFX Send & Control Room)	
Maximum Voltage Gain	MIC IN to MAIN L/R: MIC IN to ALT 3/4: MIC IN to AUX (PRE): MIC IN to AUX (POST): MIC IN to EFX (REV): MIC IN to CONTROL ROOM L/R: MIC IN to REC L/R: LINE IN to MAIN L/R: LINE IN to ALT 3/4: LINE IN to AUX (PRE): LINE IN to AUX (POST): LINE IN to EFX (REV): LINE IN to CONTROL ROOM L/R: STEREO IN to MAIN L/R: STEREO IN to ALT 3/4: AUX RETURN IN to MAIN L/R: TAPE IN to MAIN L/R:	74 dB 74 dB 66 dB 76 dB 76 dB 80 dB 52 dB 54 dB 54 dB 46 dB 56 dB 56 dB 60 dB 44 dB 44 dB 16 dB 20 dB
Crosstalk (at 1kHz)	-70 dB between input channels -70 dB between input/output channels	
Gain Control (Mono input channel)	44 dB variable (-50 dB ~-6 dB), (-30 dB ~14 dB)	
Gain Control (Mono/Stereo Combo)	40 dB variable (-20 dB ~+20 dB)	
Input Channel Equalization	High: 12 kHz Shelving Mid: 2.5 kHz Peaking Low: 80 Hz Shelving	
LED Meters	10 Segment LED x 2 (MAIN L/R, ALT 3/4, PFL, TAPE IN)	
Internal Digital Effect	100 selectable presets FOOT switch (ON/OFF)	
Channel Indicators	Peak: An indicator for each channel turns on when the pre channel fader is 5 dB below clipping	
Phantom Power	+48 V DC (Supplied when phantom power switch is turned ON)	
Included accessory	Power adapter PA-M1224	
Power supply	115 ~230 V AC / 50 ~60 Hz	
Power consumption	36 W	
Weight	4.6 Kg	
Dimensions	420 x 328 x 90 mm	

Input

<b>Input Connector</b>	<b>Input Impedance</b>	<b>Nominal Impedance</b>	<b>Rated Input Level</b>	<b>Connector Type</b>
CH Mic	4 k Ohm	50 – 600 Ohm	-50 dB	XLR 3-31 Type Balanced
CH Line	10 k Ohm	600 Ohm	-30 dB	Phone Jack (TRS)
Stereo Input Mic	3 k Ohm	600 Ohm	-44 dB	XLR 3-31 Type Balanced
Stereo Input	5 k Ohm	600 Ohm	-20 dB	Unbalanced Phone Jack
Mono Channel Insert Input	10 k Ohm	600 Ohm	0 dB	Phone Jack (TRS)
Tape in	10 k Ohm	600 Ohm	-10 dBV	RCA pin Jack

Output

<b>Output Connector</b>	<b>Output Impedance</b>	<b>Nominal Impedance</b>	<b>Rated Input Level</b>	<b>Connector Type</b>
MIX OUT L/R	240 Ohm	20 k Ohm	+4 dB	Balanced Phone Jack
ALT 3/4	75 Ohm	10 k Ohm	+4 dB	Unbalanced Phone Jack
Control Room Out	75 Ohm	10 k Ohm	+4 dB	Unbalanced Phone Jack
Aux Send	75 Ohm	600 Ohm	+4 dB	Unbalanced Phone Jack
Mono Channel Insert Output	600 Ohm	10 k Ohm	0 dB	Phone Jack (TRS)
Rec Out	600 Ohm	10 k Ohm	-10 dBV	RCA pin Jack
Phones Out	100 Ohm	33 Ohm	3 mW	Stereo Phone Jack

Personal notes