

PFI 3015

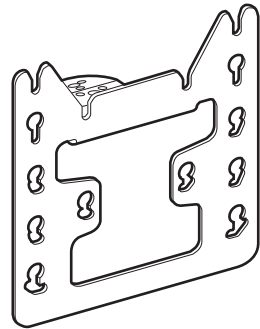

PFI 3045

EN Mounting instructions	IT Istruzioni di montaggio	RU Инструкция по сборке и установке	RO Instrucțiuni de montaj
DE Montageanleitung	PT Manual de montagem	CZE Návod k montáži	UK Вказівки по монтажі
FR Consignes d'installation	EL Οδηγίες συναρμολόγησης	BG Инструкции за монтаж	JA 設置の説明書
NL Montagevoorschrift	SV Montageföreskrifter	HU Szerelési előírás	ZH 装配说明
ES Instrucciones de montaje	PL Instrukcja montażu	TR Montaj kılavuzu	



PFI 3015 / PFI 3045 max. 30 kg / 66 lbs

PFI 3015

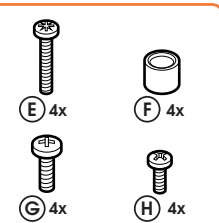
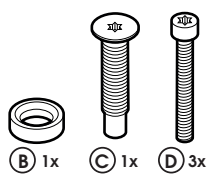
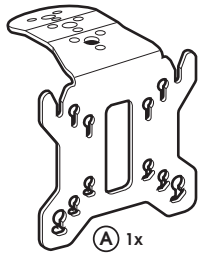

PFI 3045

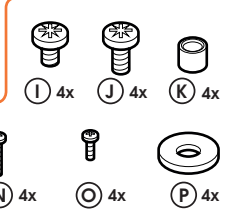
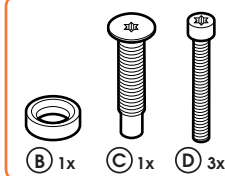

(GB) Subject to printing errors and technical amendments.
 (NL) Drukfouten en technische wijzigingen voorbehouden.
 (F) Sous réserve de fautes d'impression et de modifications techniques.
 (D) Für Druckfehler übernehmen wir keine Verantwortung. Technische Änderungen vorbehalten.
 (E) Reservados errores de imprenta y sujeta a modificaciones.
 (I) Con riserva di modifiche tecniche e di eventuali errori di stampa.
 (P) Reserva-se a ocorrência de gralhas e de modificações técnicas.
 (H) Nyomdahibák és technikai változtatások joga fenntartva.
 (PL) Zastrzeżenie się możliwość występowania błędów drukarskich i zmian technicznych.
 (RUS) Возможны ошибки при печати и технические модификации.

Designed and engineered in the Netherlands
 More information on: www.vogels.com

VOGEL'S PRODUCTS BV, HONDSRUGLAAN 93, 5628 DB EINDHOVEN, THE NETHERLANDS

1 PUC 21XX

MOUNTING TO PUC 21XX OR 23XX

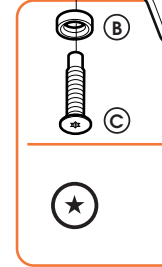
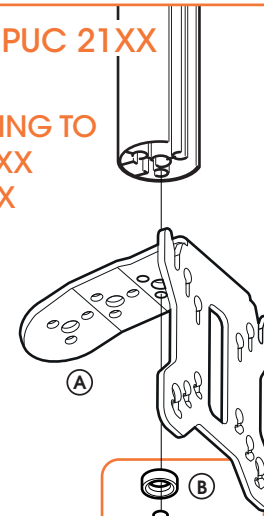

PUC 24XX

MOUNTING TO PUC 24XX

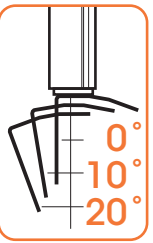
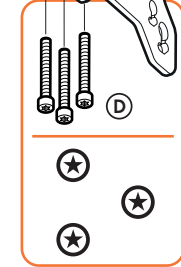
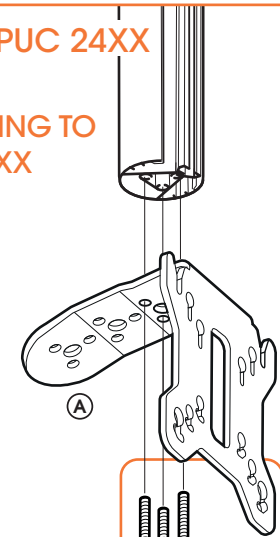

2

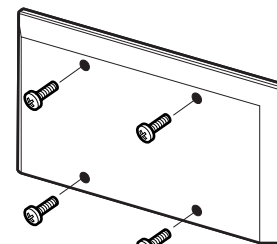

I J M8

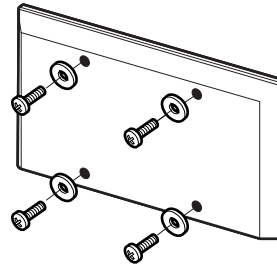

E F G H K
L M N O P
M4-M6

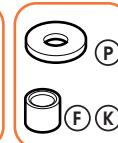
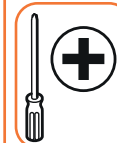

OPTIONAL

3

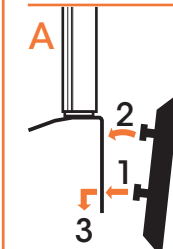
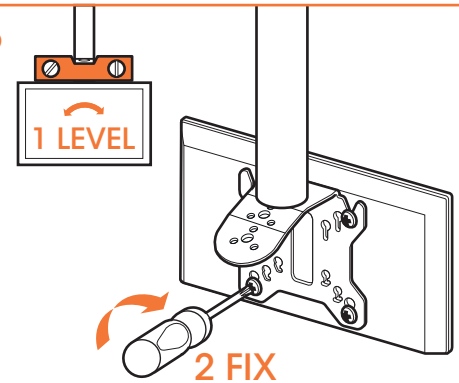

M8

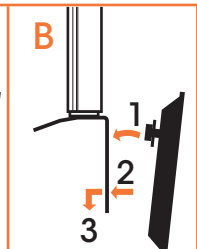

M4/M6

