



CHA530

2-Way horn loudspeaker 5"

Highlights:

- IP66 Ingress protection
- 30 Watt RMS power
- Multi-tapping 100V line transformer
- 5" Low frequency loudspeaker
- 1" HF Horn tweeter

The CHA530 is a 2-way horn loaded loudspeaker which is designed for long-throw, full range reproduction of music and speech in a wide variety of indoor and outdoor applications.

The construction is composed of a 1" high frequency compression driver and a 5" mid/low frequency driver. The selection of high-quality components and acoustic engineering craftsmanship makes the CHA530 significantly better performing than other traditional horn speakers. A smooth frequency response and high efficiency ensures an extraordinary clarity of speech and extended frequency response for music.

It features an RMS power handling of 30 Watt and a max power handling of 60 Watt. The sensitivity measures 98 dB while a maximum continuous SPL of 113 dB can be achieved. The frequency response (± 3 dB) starts from 110 Hz up to 16 kHz.

A multi-tapping line transformer allows the speaker to be used in 100 Volt and 70 Volt public address systems. It is connected using a waterproof rotatable AWX-5 connector whereby the desired power tap is selected depending on the rotation of the connector. Various power tapings for 30 Watt, 15 Watt, 7.5 Watt and 3.75 Watt are available.

The enclosure is constructed using high quality UV and impact resistant ABS materials and an included stainless steel mounting bracket allows secure mounting and tilting for perfect directional placement. This makes it comply with IP66 ingress protection requirements, resulting in a weatherproof solution for permanent outdoor installation.

Connection of the loudspeaker is done using a screw terminal block connector located in a waterproof connection box on the rear of the speaker.

Applications:

- Retail
- Public facilities
- Corporate spaces
- Sport facilities



Properties:



Voltage:

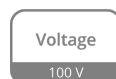

Usage:



System specifications:

Speaker type		2-way horn speaker
Max. Power		60 W
RMS Power		30 W
Line Transformer Tappings	1	30 W / 333 Ω
	2	15 W / 667 Ω
	3	7.5 W / 1330 Ω
	4	3.75 W / 2660 Ω
Sensitivity (1W/1m)		98 dB
Sound Pressure (Max. W/1m)	@ 100 V	113 dB
Frequency	Response (\pm 3 dB)	110 Hz - 16 kHz
Crossover	Type	Passive built-in
Dispersion	Horizontal	110°
	Vertical	60°
Ingress Protection rating		IP66
Drivers		5" MF / LF Woofer
	HF	1" HF Horn tweeter
Connection		AWX5™ waterproof

Product Features:

Dimensions		310 x 215 x 330 mm (W x H x D)
Weight		4.7 kg
Construction		Impact & UV resistant ABS
Colours		Light grey (RAL7035)
Mounting & handling		Powder coated steel
Accessories	Included	Mounting bracket

Shipping & Ordering:

Packaging	Cardboard box
Shipping weight & volume	6 kg - 0.04 Cbm

Architects' and Engineers' Specifications:

The loudspeaker shall be a 2-way horn loaded system, providing a long-throw full range sound projection of music and speech. The construction shall be composed of a 1" HF compression driver and a 5" mid/low frequency driver which are housed in a impact and UV resistant ABS housing. It shall have an RMS power handling of 30 Watt with a maximum power handling of 60 Watt and the frequency response (± 3 dB) shall range from 110 Hz to 16 kHz. The sensitivity shall be 98 dB when measuring with an input signal of 1 Watt at a distance of 1 meter, while the maximum continuous sound pressure level shall achieve 113 dB. The loudspeaker shall contain a passive built-in crossover network. For use in public address systems, a multi-tapping 100 Volt built-in line transformer with power taps for 30 Watt, 15 Watt, 7.5 Watt and 3.75 Watt shall be provided. Connecting the loudspeaker is done through a screw terminal block connector in a waterproof connection box on the rear of the speaker. An included steel mounting bracket allows a secure mounting and optimal directional placement. A truly weatherproof construction complying with IP66 Ingress protection requirements shall be met. The system's enclosure shall be 215 mm high, 310 mm wide and 330 mm deep and the weight shall not exceed 4.7 Kg.

Acoustical data graphs:

Horizontal Polars:

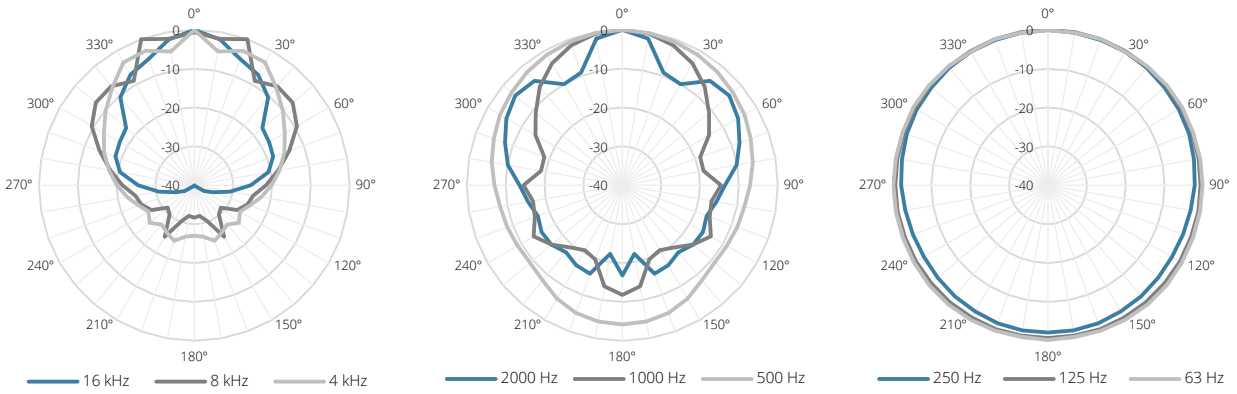

Vertical Polars:

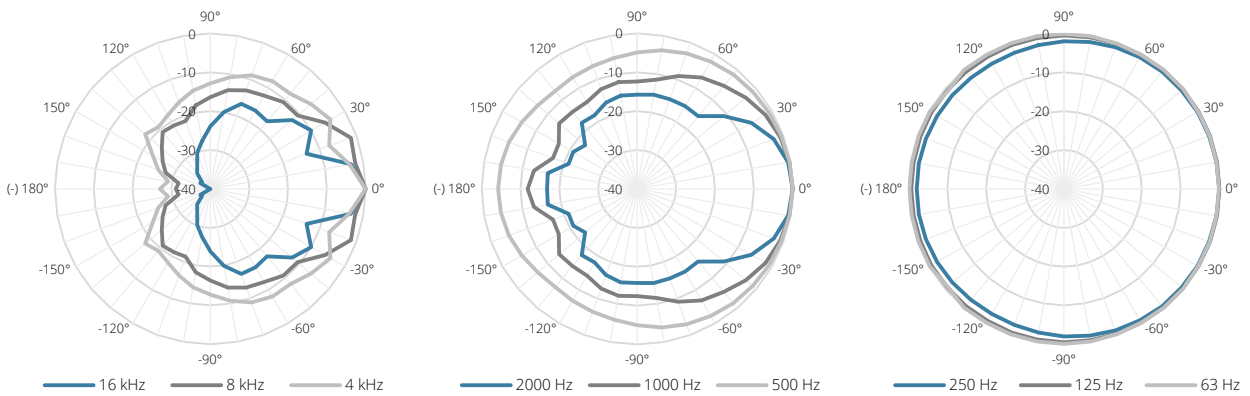

Sensitivity:

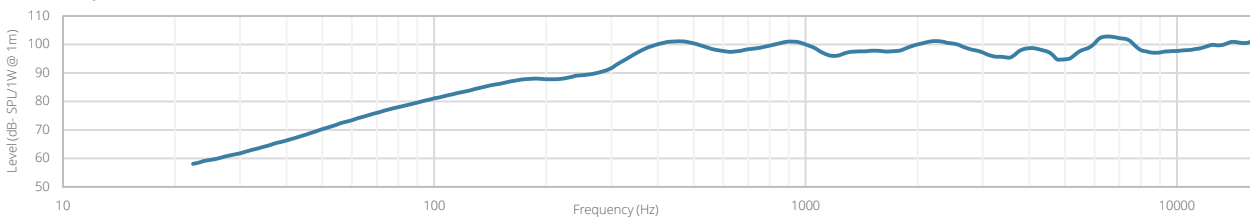

Beamwidth (-3dB):

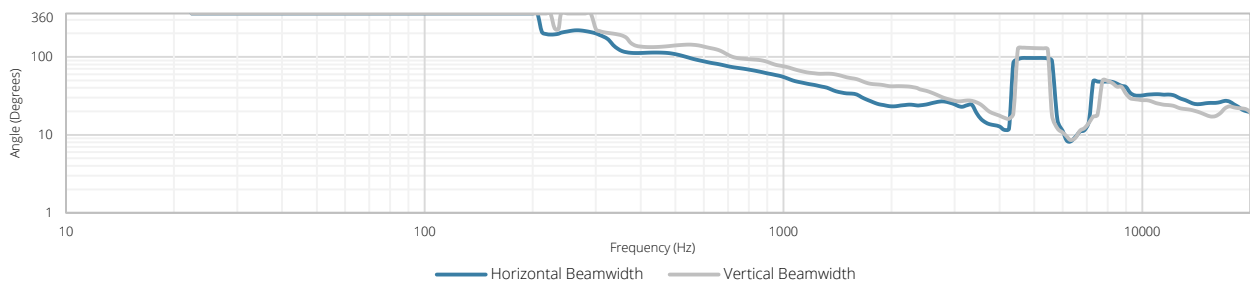

Directivity index:

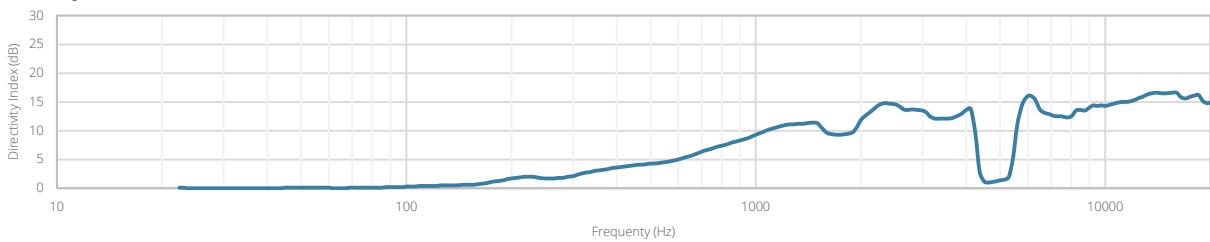

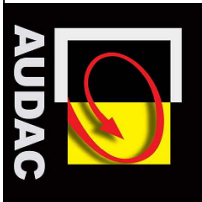
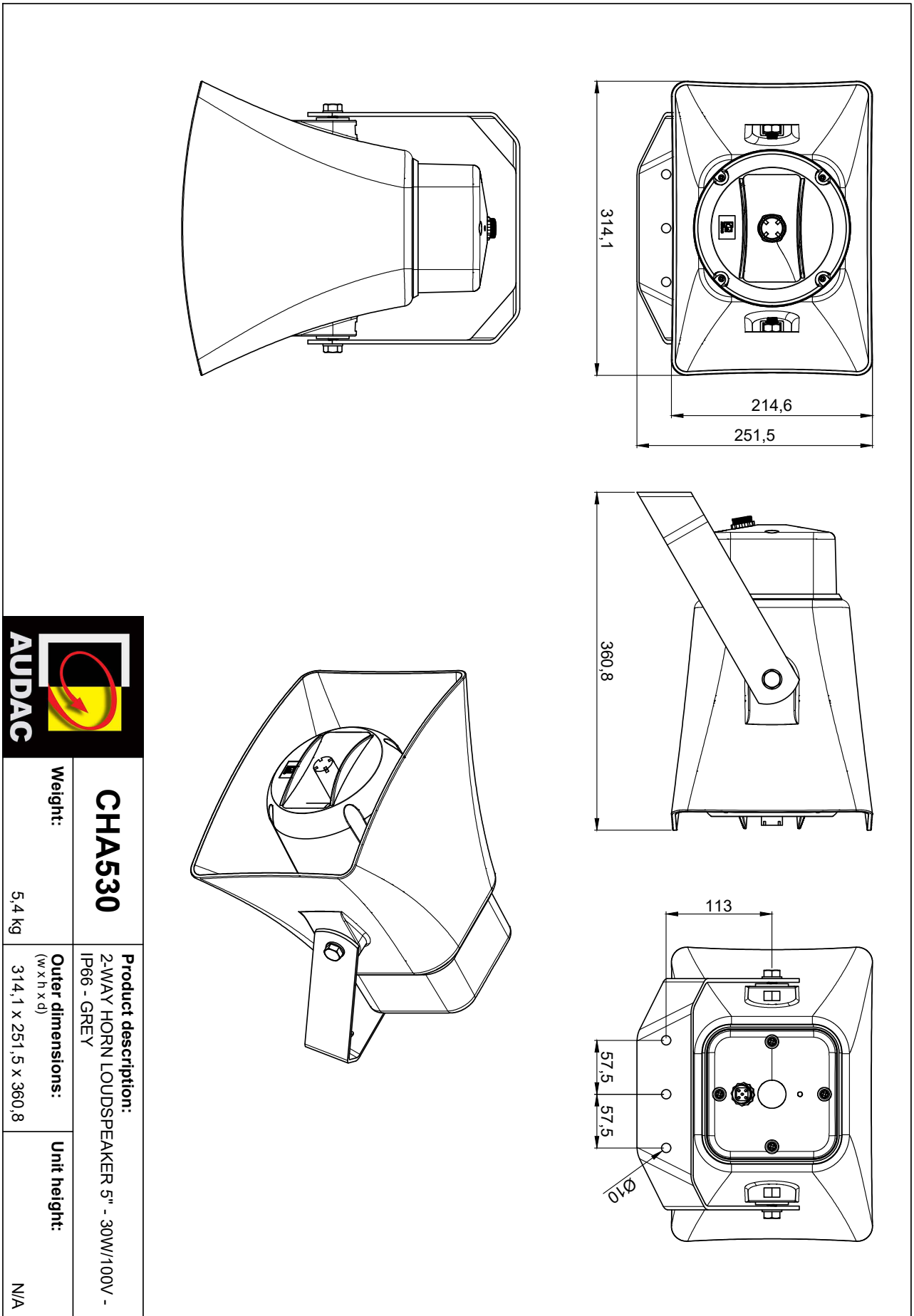

CHA530

Weight:

5,4 kg

Product description:
2-WAY HORN LOUDSPEAKER 5" - 30W/100V -
IP66 - GREY

Outer dimensions:
(w x h x d)

314,1 x 251,5 x 360,8

Unit height:

N/A