



MBK112

Mounting bracket for PX112 speaker

The MBK112 series mounting brackets are especially designed for the mounting of the AUDAC PX series speakers. These black brackets allow mounting the speakers in any possible situation. For the mounting of the PX series speaker with the corresponding bracket, the pole flange adapter in the bottom of the speaker has to be replaced with a screw flange adapter, which is included. They are constructed of solid steel, and come with all the necessary parts for safe mounting, such as 2 M10 bolts and a safety cable with M10 eye bolt mounting. This bracket is also available in white, MBK112/W



Product Features:

Dimensions	50 x 670 x 345 mm (W x H x D)	
Weight	3.220 kg	
Construction	Steel	
Colours	Black (MBK112) White (MBK112W)	
Accessories	Included	screw flange adapter, M10 bolts, M10 eye bolt, safety cable

Variants:

- MBK112 - Black version
- MBK112W - White version

Shipping & Ordering:

Compatible with	PX112
Packaging	Cardboard box
Shipping weight	3.450 kg

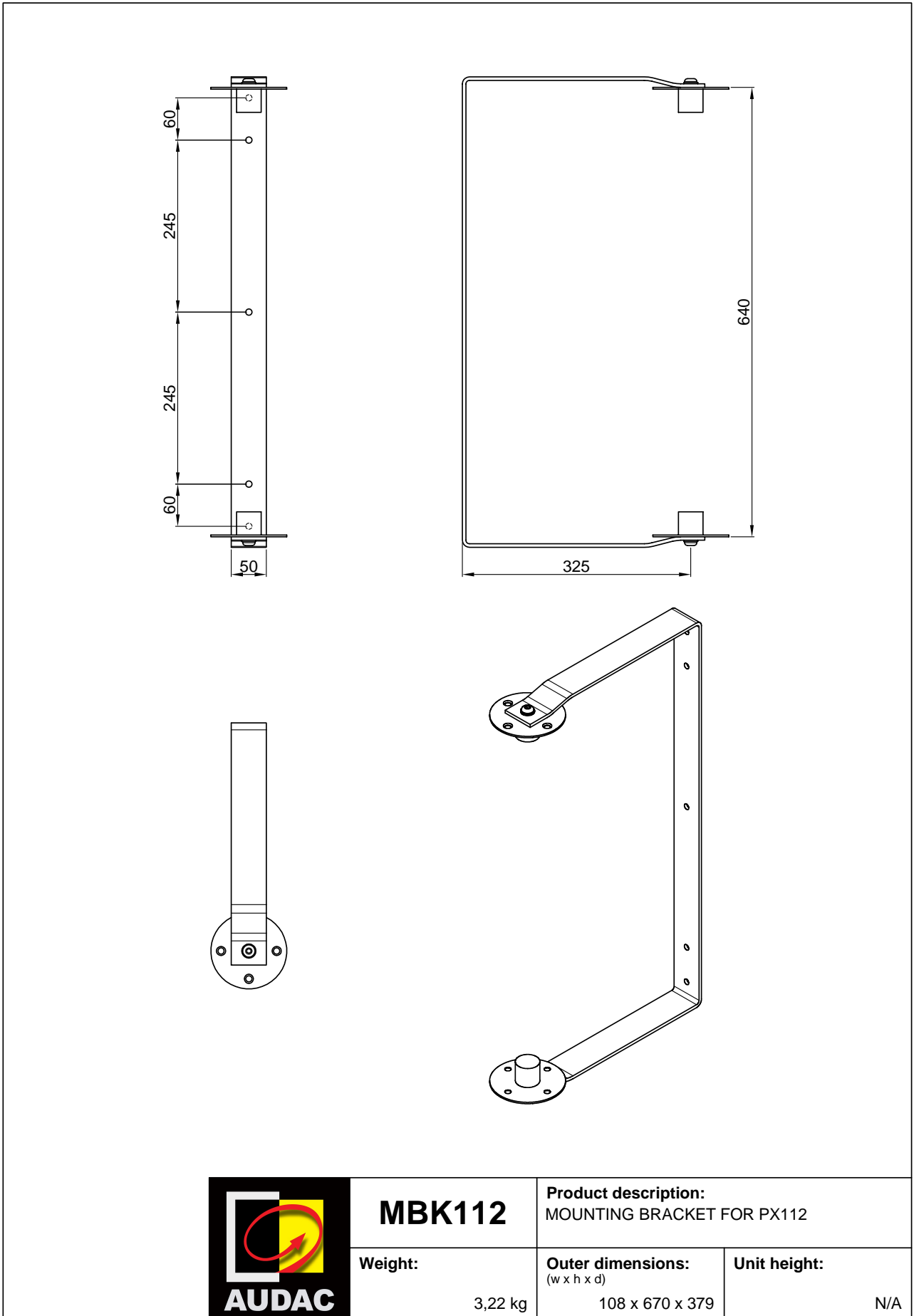

MBK112	Product description: MOUNTING BRACKET FOR PX112		
	Weight: 3,22 kg	Outer dimensions: (w x h x d) 108 x 670 x 379	Unit height: N/A