



# KRAMER

## RK-3T

19-Inch Rack Adapter for TOOLS™

---

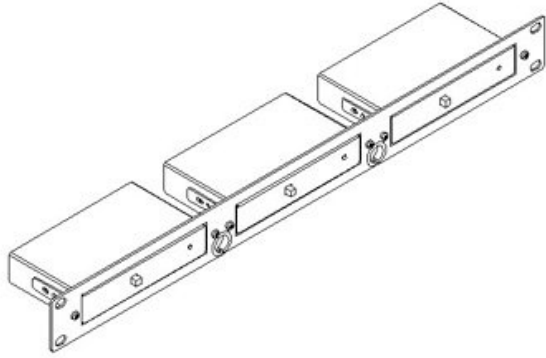

19-inch rack adapter for mounting 3 Kramer TOOLS™ into a 1U rack space

### FEATURES

---

**Compatibility** - Models compatible with the RK-3T are also compatible with racks: RK-6T, RK-9T, RK-1T2PT, RK-2T1PT & RK-T2SB



# KRAMER

## TECHNICAL SPECIFICATIONS

---

PRODUCT DIMENSION: 19" x 1.85 x 1U (43.6cm x 4.70cm 4.40cm) W, D, H

PRODUCT WEIGHT: 0.2kg (0.5lbs) approx

SHIPPING DIMENSION: 48.90cm x 9.50cm x 2.30cm (19.25" x 3.74" x 0.91" ) W, D, H

SHIPPING WEIGHT: 0.6kg (1.2lbs) approx