

STX660(P) STX660L



Display size
39"-90"



Max load
150lb (68kg)

SMARTMOUNT XT

Universal Tilt Wall Mount

FOR 39" TO 90" DISPLAYS

Limitless placement opportunities are delivered with speed and ease with both horizontal and vertical adjustment capability. Its slim, open wall plate architecture delivers display placement flexibility and enables hands-free behind-the-display access along with cable management. Quick and easy installation and optional IncreLok™ Tilt technology complete the ultimate secure, low profile display installation.

STX660's pre-tensioned universal tilt adaptor brackets offer up to +15/-5° of One-Touch™ tilt adjustment in one easy motion.



Additional Features

- ✓ Open wall plate design allows for total wall access, increasing electrical and cable management options
- ✓ Optional IncreLok™ feature offers fixed tilt lock in 5° increments
- ✓ Easy-Glide™ design ensures that the display is securely attached to the wall plate
- ✓ 5° of back tilt offers 3" of space for hands-free, behind the display access
- ✓ Up to 23" (584mm) of horizontal adjustment for centering display on wall
- ✓ Up to 1" (25mm) of vertical adjustment on each universal display adaptor bracket for post-installation leveling and height adjustment fine-tuning
- ✓ Universal tilt adaptor brackets easily hook onto wall plate for fast installation
- ✓ Low profile design holds display 1.69" (43mm) from the wall
- ✓ Fits displays with mounting hole patterns from 100 x 100mm (3.94"W x 3.94"H) to 805 x 405mm (31.71"W x 15.95"H)

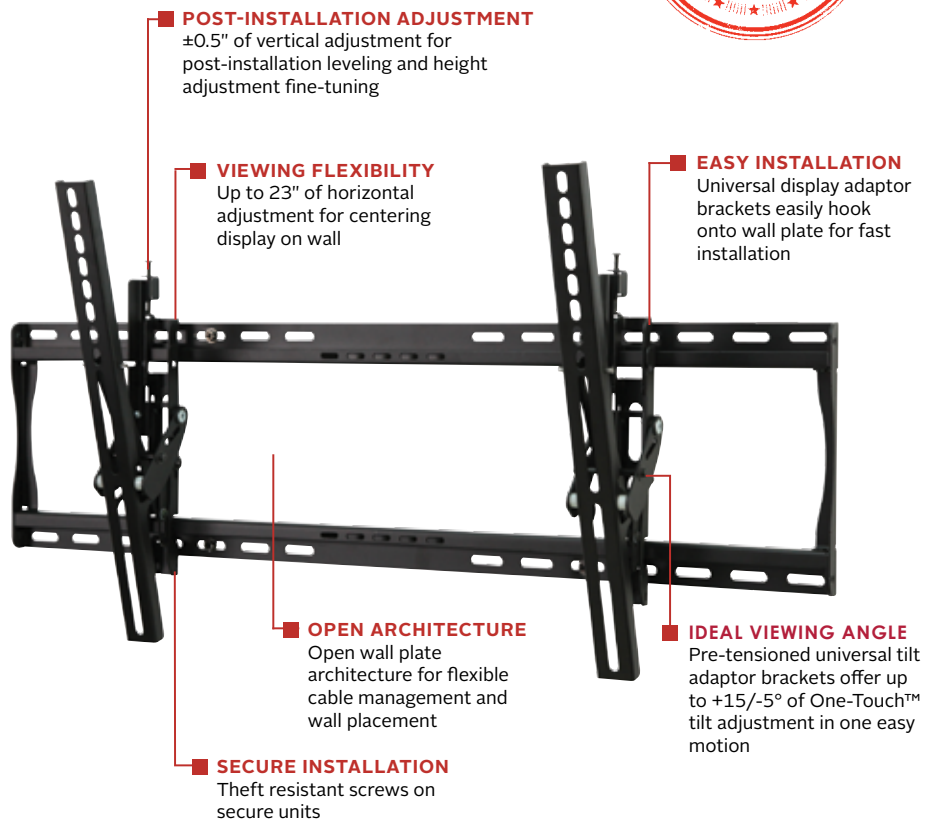

Patented. Design Patent No. D659.689.
Utility Patent No. 8,313,073; 8,348,212; 8,282,059; 8,517,322.



INTEGRATED
PARTNER
PROGRAM

Contact your Peerless-AV sales representative for more information



Increased security with included Master Lock 510KAD keyed-alike padlock on locking model

STX660	SmartMountXT™ Universal Tilt Wall Mount for 39" to 90" Displays - security models
STX660L	SmartMountXT™ Universal Tilt Wall Mount for 39" to 90" Displays - security locking model
STX660P	SmartMountXT™ Universal Tilt Wall Mount for 39" to 90" Displays - standard models

Product Specifications

	DIMENSIONS (W x H x D)	PRODUCT WEIGHT	LOAD CAPACITY	FINISH	AVAILABLE COLORS
STX660(P)	34.12" x 16.89" x 1.69"-6.55" (867 x 429 x 43-166mm)	8.63lb (3.91kg)	150lb (68kg)	Powder coat	Black
STX660L		9.13lb (4.14kg)			

Package Specifications

	PACKAGE SIZE (W x H x D)	PACKAGE SHIP WEIGHT	PACKAGE UPC CODE	PACKAGE CONTENTS	UNITS IN PACKAGE
STX660(P)	10.125" x 3.5" x 35.875" (257 x 89 x 991mm)	11.7lb (5.31kg)	STX660: 735029278979	Universal Tilt Wall Mount, attachment hardware, installation instructions	1
STX660L		12.2lb (5.53kg)	STX660L: 735029278986		
			STX660P: 735029279396		

Accessories

- ACCXT302:** SmartMountXT™ Video Conferencing Shelf accessory
- ACCXT400:** In-Wall Cable and Power Management Accessory with AC Surge Suppressor

All dimensions = inch (mm)

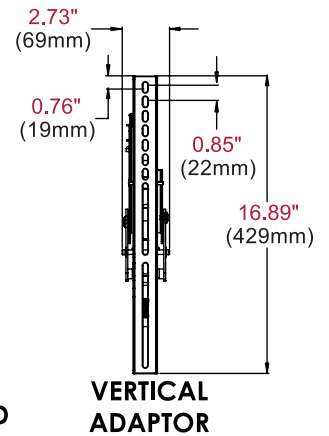
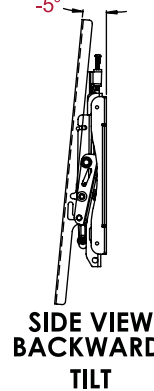
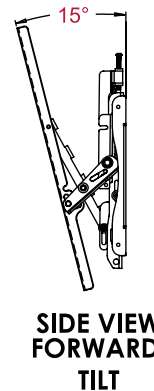
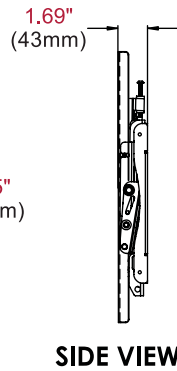
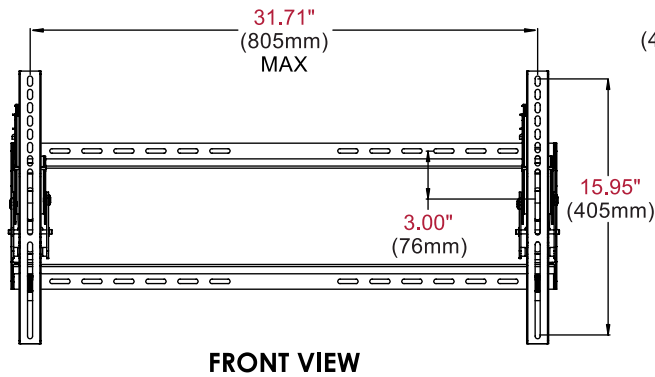
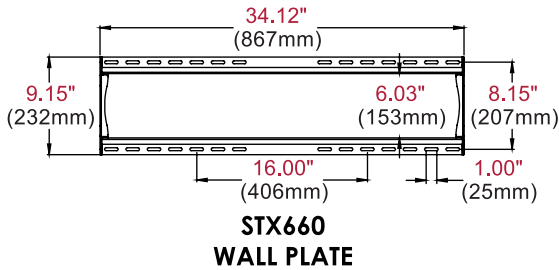

Architect Specifications

The SmartmountXT™ Universal Tilt Wall Mount shall be a Peerless-AV® model STX660, STX660L or STX660P and shall be located where indicated on the plans. Assembly and installation shall be done according to instructions provided by the manufacturer.

Visit peerless-av.com to see the complete line of AV solutions from Peerless-AV, including outdoor displays, wireless, kiosks, digital audio, display mounts, projector mounts, carts/stands, and a full assortment of accessories.

Peerless-AV
2300 White Oak Circle
Aurora, IL 60502 USA
(800) 865-2112
(630) 375-5100
Fax: (800) 359-6500

Peerless-AV Europe
Unit 3 Watford Interchange
Colonial Way, Watford
Herts, WD24 4WP
United Kingdom
+44 (0) 1923 200100
Fax: +44 (0) 1923 200101

Peerless-AV de México
Ave de las Industrias 413
Parque Industrial Escobedo
Escobedo, N.L.,
Mexico 66050
+52 (81) 8384-8300
Fax: +52 (81) 8384-8360

