

Kramer Electronics, Ltd.

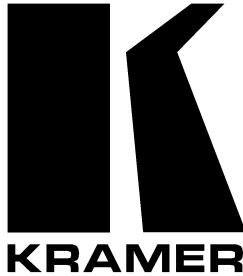

USER MANUAL

Model:

VM-9T

Video-Audio Line Amplifier / CAT5 Transmitter

Contents

1	Introduction	1
2	Getting Started	1
2.1	Quick Start	1
3	Overview	3
3.1	About the VM-9T	3
3.2	About the Power Connect Feature	3
3.3	Shielded Twisted Pair (STP) / Unshielded Twisted Pair (UTP)	4
3.4	Recommendations for Achieving the Best Performance	4
4	Your VM-9T Video-Audio Line Amplifier / CAT5 Transmitter	5
5	Connecting the VM-9T	7
6	Technical Specifications	9

Figures

Figure 1: VM-9T Video-Audio Line Amplifier / CAT5 Transmitter	5
Figure 2: VM-9T Underside	6
Figure 3: Connecting the VM-9T Unit	8

Tables

Table 1: VM-9T Video-Audio Line Amplifier / CAT5 Transmitter Features	5
Table 2: VM-9T Underside Feature	6
Table 3: Technical Specifications of the VM-9T	9

1 Introduction

Welcome to Kramer Electronics (since 1981): a world of unique, creative and affordable solutions to the infinite range of problems that confront the video, audio and presentation professional on a daily basis. In recent years, we have redesigned and upgraded most of our line, making the best even better! Our 500-plus different models now appear in 8 Groups¹, which are clearly defined by function.

Congratulations on purchasing your **VM-9T Video-Audio Line Amplifier / CAT5 Transmitter**, which is ideal for the following typical applications:

- Video signal distribution
- Video duplication studios

The package includes the following items:

- **VM-9T** Video-Audio Line Amplifier / CAT5 Transmitter
- Power cord
- This user manual²

2 Getting Started

We recommend that you:

- Unpack the equipment carefully and save the original box and packaging materials for possible future shipment
- Review the contents of this user manual
- Use Kramer high performance high resolution cables³

2.1 Quick Start

The quick start chart summarizes the basic setup and operation.

1 GROUP 1: Distribution Amplifiers; GROUP 2: Video and Audio Switchers, Matrix Switchers and Controllers; GROUP 3: Video, Audio, VGA/XGA Processors; GROUP 4: Interfaces and Sync Processors; GROUP 5: Twisted Pair Interfaces; GROUP 6: Accessories and Rack Adapters; GROUP 7: Scan Converters and Scalers; and GROUP 8: Cables and Connectors

2 Download up-to-date Kramer user manuals from the Internet at this URL: <http://www.kramerelectronics.com>

3 The complete list of Kramer cables is on our Web site at <http://www.kramerelectronics.com>

Step 1: Mount the machine

Rack-mount the machine using a 19" rack adapter, RK-1, or stick the 4 rubber feet to the underside

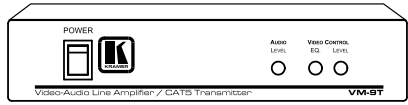

Step 2: Connect the VM-9T - see section 5

- 1 Connect the input and the output to the VM-9T
- 2 Connect the audio and video outputs of the VM-9T to the 712N
- 3 Connect the VM-9T to the 712N via the CAT5 cable

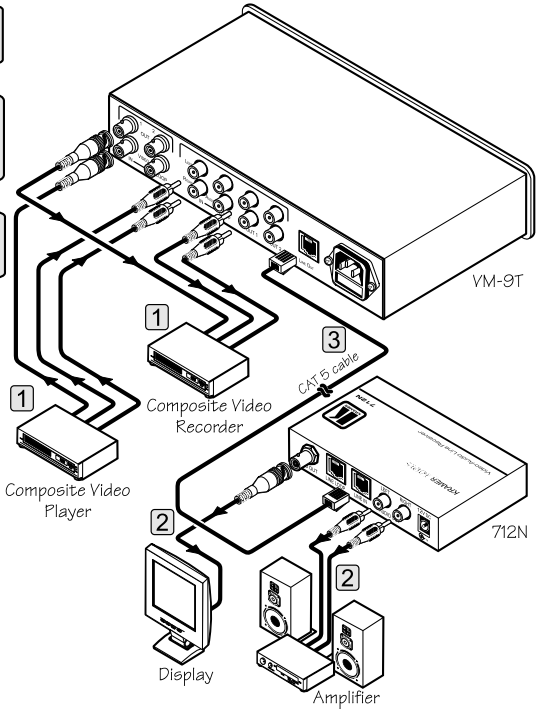

Step 3: Turn the power ON

Step 4: If required:

- Set the video termination button (on the underside)
- Adjust the front panel controls for audio level, video output level and video cable equalization

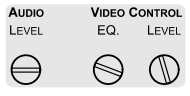

3 Overview

This section describes:

- The **VM-9T**, see section 3.1
- The power connect feature, see section 3.2
- Using shielded twisted pair (STP) / unshielded twisted pair (UTP), see section 3.3
- Recommendations for achieving the best performance, see section 3.4

3.1 About the VM-9T

The Kramer **VM-9T** is a high quality video audio line amplifier / CAT5 transmitter. It has looping inputs with selectable video input signal termination, and distributes the signals to two identical outputs. The composite video signals are on BNC connectors and the audio signals on RCA connectors. In particular, the **VM-9T**:

- Transmits the video and audio signal over CAT5 UTP cable to the appropriate receiver with a transmission range of well beyond 1600 ft. (more than 500 meters) over UTP cabling
- Has a video bandwidth that exceeds 350MHz, ensuring transparency even when operating at the highest resolution
- Features front panel controls for audio level, video output level and video cable equalization
- Is housed in a desktop sized enclosure and is fed from a 100-240 VAC universal switching power supply

3.2 About the Power Connect Feature

The Power Connect feature lets you power a transmitter / receiver system by connecting just one power adapter—to either the transmitter or the receiver. The other unit is fed via the cable connecting between the transmitter/receiver. The Power Connect feature applies as long as the cable can carry power. The distance does not exceed 50 meters on standard CAT5 cable, for longer distances, heavy gauge cable should be used¹.

For a CAT5 cable exceeding a distance of 50 meters, separate power supplies should be connected to the transmitter and to the receiver simultaneously.

The power connect feature applies to the **VM-9T**. The **VM-9T** can power, for example, the **712N** receiver (see the example illustrated in Figure 3). **However, the 712N cannot power the VM-9T.**

¹ CAT5 cable is still suitable for the video/audio transmission, but not for feeding the power at these distances

3.3 Shielded Twisted Pair (STP) / Unshielded Twisted Pair (UTP)

The decision whether to use shielded twisted pair (STP) cable or unshielded twisted pair (UTP) cable depends on the nature of the application.

It is recommended that in applications with high interference, shielded twisted pair (STP) cable is used. However, the shield itself does create a capacitance that degrades the frequency response of the machines. For shorter distances, of 50m or so, shielded twisted pair (STP) cable is preferred because it provides protection from interference (degradation is not apparent).

For long range applications, unshielded twisted pair (UTP) cable is preferred. However, the unshielded twisted pair (UTP) cable should be installed far away from electric cables, motors and so on, which are prone to create electrical interference.

3.4 Recommendations for Achieving the Best Performance

To achieve the best performance:

- Connect only good quality connection cables, thus avoiding interference, deterioration in signal quality due to poor matching, and elevated noise- levels (often associated with low quality cables)
- Avoid interference from neighboring electrical appliances that may adversely influence signal quality and position your **Kramer VM-9T** away from moisture, excessive sunlight and dust

4 Your VM-9T Video-Audio Line Amplifier / CAT5 Transmitter

Figure 1 and Table 1 define the **VM-9T**:

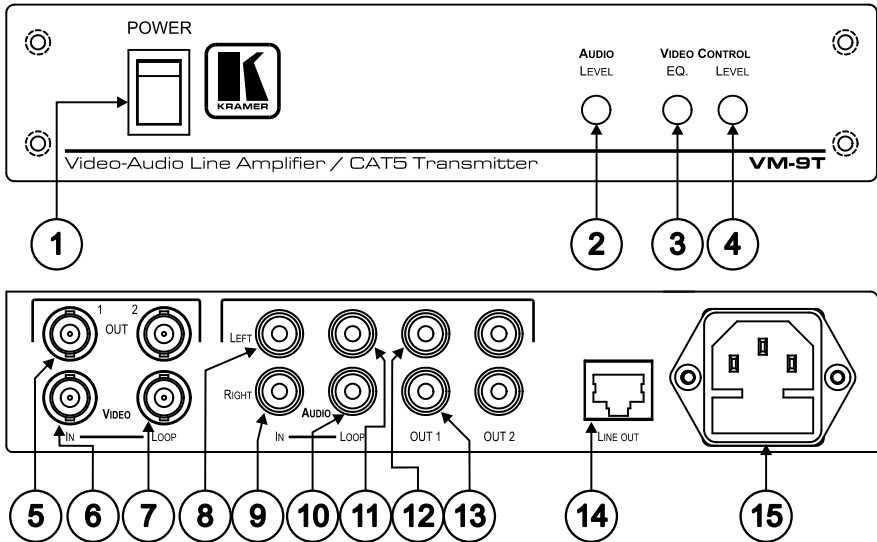

Figure 1: VM-9T Video-Audio Line Amplifier / CAT5 Transmitter

Table 1: VM-9T Video-Audio Line Amplifier / CAT5 Transmitter Features

#	Feature	Function
1	POWER Switch	Illuminated switch for turning the unit ON or OFF
2	AUDIO LEVEL Control	Adjust ¹ the audio signal output level
3	VIDEO EQ. Control	Adjust the cable compensation equalization level
4	VIDEO LEVEL Control	Adjust the output signal level
5	VIDEO OUT BNC Connector	Connects to the video acceptor (from 1 to 2)
6	VIDEO IN BNC Connector	Connects to the video source
7	VIDEO LOOP BNC Connector	For looping the input (if required)
8	LEFT AUDIO IN RCA Connector	Connects to the left audio source
9	RIGHT AUDIO IN RCA Connector	Connects to the right audio source
10	LEFT AUDIO LOOP RCA Connector	For looping the input (if required)
11	RIGHT AUDIO LOOP RCA Connector	For looping the input (if required)
12	LEFT AUDIO OUT RCA Connector	Connects to the audio acceptor (from 1 to 2)
13	RIGHT AUDIO OUT RCA Connector	Connects to the audio acceptor (from 1 to 2)
14	LINE OUT RJ-45 CAT5 Connector	Connect to a line input on a receiver
15	Power Connector with FUSE	AC connector for supplying power to the unit

¹ Rotate carefully to adjust the appropriate level

Figure 2 and Table 2 define the underside panel:

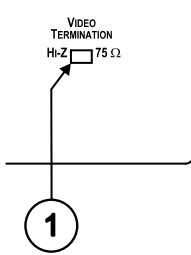

Table 2: VM-9T Underside Feature

#	Feature	Function
1	VIDEO TERMINATION Switch	Set to 75Ω ¹ to terminate with 75Ω , or move to Hi-Z for looping

Figure 2: VM-9T Underside

¹ The factory default

5 Connecting the VM-9T

To connect a **VM-9T** with the **712N**, as illustrated in the example in Figure 3, do the following¹:

1. On the **VM-9T Video-Audio Line Amplifier / CAT5 Transmitter**, connect:
 - A composite video source (for example, a composite video player) to the VIDEO IN BNC connector and to the AUDIO IN RIGHT and LEFT RCA connectors
 - Up to two² VIDEO OUT BNC connectors, and the two pairs of AUDIO RIGHT and LEFT RCA connectors, to up to two acceptors (for example, composite video recorders)
 - The VIDEO LOOP BNC connector, and the AUDIO LOOP RIGHT and LEFT RCA connectors, to the units of an additional unit (optional)
 - The LINE OUT connector to the LINE IN connector of the receiver, for example, the **712N**, via UTP cabling
 - The power cord to the mains electricity
2. On the **712N Video-Audio Line Receiver**, connect:
 - The VIDEO OUT BNC connector to a composite video acceptor (for example, a display)
 - An additional output, if required (optional), by connecting the LINE LOOP connector to the LINE IN connector of another **712N** unit, via UTP cabling
 - A 12V DC power adapter to the power socket and connect the adapter to the mains electricity. Alternatively, the **712N** can be powered via the **VM-9T** (see the power connect feature in section 3.2)
 - If required, adjust the VIDEO GAIN and EQ. levels, by inserting a screwdriver into each of the small holes and carefully rotating them

¹ Switch OFF the power on each device before connecting it to your VM-9T. After connecting your VM-9T, switch on its power and then switch on the power on each device

² When only one output is required, connect only that output, and leave the other output unconnected, as in Figure 3

Connecting the VM-9T

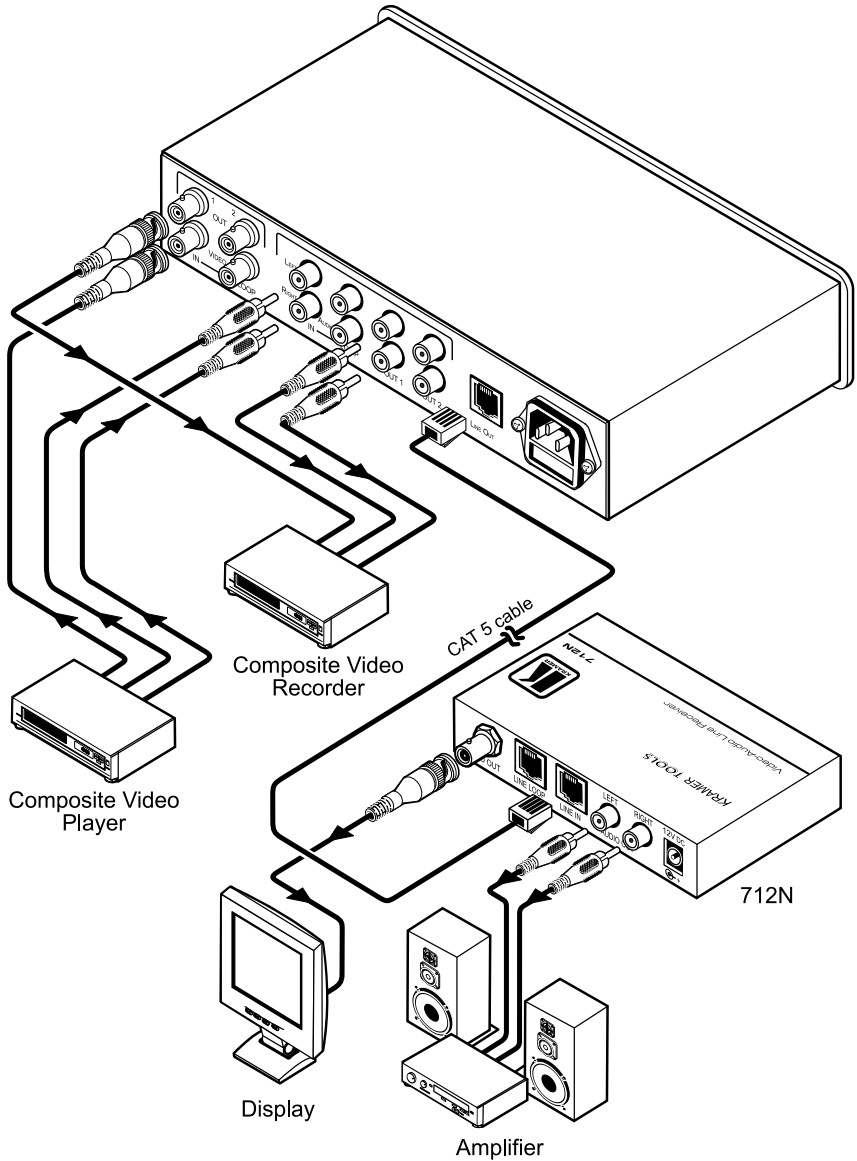

Figure 3: Connecting the VM-9T Unit

6 Technical Specifications

Table 3 includes the technical specifications:

Table 3: Technical Specifications¹ of the VM-9T

INPUTS:	1 looping composite video 1 Vpp/75Ω on a BNC connector 1 looping stereo audio +4dBm, on RCA connectors	
OUTPUTS:	2 composite video 1 Vpp/75Ω on BNC connectors 2 stereo audio +4dBm, on RCA connectors 1 CAT5 on an RJ-45 connector	
MAX. OUTPUT LEVEL:	VIDEO: 2.4Vpp	AUDIO: +21dBm
BANDWIDTH (-3dB):	VIDEO: 350MHz	AUDIO: 43kHz
DIFF. GAIN:	0.04%	
DIFF. PHASE:	0.06 Deg.	
K-FACTOR:	<0.05%	
S/N RATIO:	76MHz	
CROSSTALK (all hostile):	-67dB	
CONTROLS:	VIDEO: Level: -0.4dB to +6dB EQ.: 0dB to +10dB @ 50MHz	AUDIO: Level: -12dB to +12dB
COUPLING:	VIDEO: DC	AUDIO: AC
AUDIO THD + NOISE:	0.02%	
AUDIO 2nd HARMONIC:	0.005%	
POWER SOURCE:	100-240 VAC, 50/60Hz 12 VA	
DIMENSIONS:	21.46cm x 16.25cm x 4.36cm (8.45" x 6.39" x 1.72", W, D, H)	
WEIGHT:	1.4 kg (3.3 lbs.) approx.	
ACCESSORIES:	Power cord	

¹ Specifications are subject to change without notice

LIMITED WARRANTY

Kramer Electronics (hereafter *Kramer*) warrants this product free from defects in material and workmanship under the following terms.

HOW LONG IS THE WARRANTY

Labor and parts are warranted for seven years from the date of the first customer purchase.

WHO IS PROTECTED?

Only the first purchase customer may enforce this warranty.

WHAT IS COVERED AND WHAT IS NOT COVERED

Except as below, this warranty covers all defects in material or workmanship in this product. The following are not covered by the warranty:

1. Any product which is not distributed by Kramer, or which is not purchased from an authorized Kramer dealer. If you are uncertain as to whether a dealer is authorized, please contact Kramer at one of the agents listed in the Web site www.kramerelectronics.com.
2. Any product, on which the serial number has been defaced, modified or removed.
3. Damage, deterioration or malfunction resulting from:
 - i) Accident, misuse, abuse, neglect, fire, water, lightning or other acts of nature
 - ii) Product modification, or failure to follow instructions supplied with the product
 - iii) Repair or attempted repair by anyone not authorized by Kramer
 - iv) Any shipment of the product (claims must be presented to the carrier)
 - v) Removal or installation of the product
 - vi) Any other cause, which does not relate to a product defect
 - vii) Cartons, equipment enclosures, cables or accessories used in conjunction with the product

WHAT WE WILL PAY FOR AND WHAT WE WILL NOT PAY FOR

We will pay labor and material expenses for covered items. We will not pay for the following:

1. Removal or installations charges.
2. Costs of initial technical adjustments (set-up), including adjustment of user controls or programming. These costs are the responsibility of the Kramer dealer from whom the product was purchased.
3. Shipping charges.

HOW YOU CAN GET WARRANTY SERVICE

1. To obtain service on you product, you must take or ship it prepaid to any authorized Kramer service center.
2. Whenever warranty service is required, the original dated invoice (or a copy) must be presented as proof of warranty coverage, and should be included in any shipment of the product. Please also include in any mailing a contact name, company, address, and a description of the problem(s).
3. For the name of the nearest Kramer authorized service center, consult your authorized dealer.

LIMITATION OF IMPLIED WARRANTIES

All implied warranties, including warranties of merchantability and fitness for a particular purpose, are limited in duration to the length of this warranty.

EXCLUSION OF DAMAGES

The liability of Kramer for any effective products is limited to the repair or replacement of the product at our option. Kramer shall not be liable for:

1. Damage to other property caused by defects in this product, damages based upon inconvenience, loss of use of the product, loss of time, commercial loss; or:
2. Any other damages, whether incidental, consequential or otherwise. Some countries may not allow limitations on how long an implied warranty lasts and/or do not allow the exclusion or limitation of incidental or consequential damages, so the above limitations and exclusions may not apply to you.

This warranty gives you specific legal rights, and you may also have other rights, which vary from place to place.

NOTE: All products returned to Kramer for service must have prior approval. This may be obtained from your dealer.

This equipment has been tested to determine compliance with the requirements of:

- EN-50081: "Electromagnetic compatibility (EMC);
generic emission standard.
Part 1: Residential, commercial and light industry"
- EN-50082: "Electromagnetic compatibility (EMC) generic immunity standard.
Part 1: Residential, commercial and light industry environment".
- CFR-47: FCC Rules and Regulations;
Part 15: "Radio frequency devices
Subpart B Unintentional radiators"

CAUTION!

- ⊗ Servicing the machines can only be done by an authorized Kramer technician. Any user who makes changes or modifications to the unit without the expressed approval of the manufacturer will void user authority to operate the equipment.
- ⊗ Use the supplied DC power supply to feed power to the machine.
- ⊗ Please use recommended interconnection cables to connect the machine to other components.



For the latest information on our products and a list of Kramer distributors, visit our Web site: www.kramerelectronics.com, where updates to this user manual may be found. We welcome your questions, comments and feedback.



Caution

Safety Warning:

Disconnect the unit from the power supply before opening/servicing.



Kramer Electronics, Ltd.

Web site: www.kramerelectronics.com

E-mail: info@kramerel.com

P/N: 2900-000265 REV 1