

Kramer Electronics, Ltd.

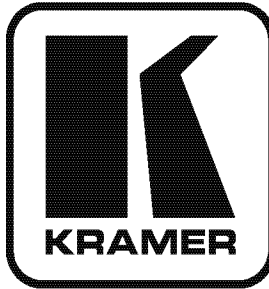

USER MANUAL

Model:

VP-418xl

Video to HDMI Scaler

Contents

| | | |
|----------|---|----------|
| 1 | Introduction | 1 |
| 2 | Getting Started | 1 |
| 2.1 | Quick Start | 1 |
| 3 | Overview | 3 |
| 3.1 | About HDMI | 3 |
| 3.2 | Recommendations for Best Performance | 4 |
| 4 | Your VP-418xl Video to HDMI Scaler | 5 |
| 5 | Connecting the VP-418xl Video to HDMI Scaler | 6 |
| 5.1 | Connecting the Contact Closure Remote Control PINs | 8 |
| 6 | Technical Specifications | 8 |

Figures

| | | |
|-----------|--|---|
| Figure 1: | VP-418xl Video to HDMI Scaler | 5 |
| Figure 2: | Connecting the VP-418xl Video to HDMI Scaler | 7 |
| Figure 3: | Connecting the Contact Closure Remote Control PINs | 8 |

Tables

| | | |
|----------|---|---|
| Table 1: | Features and Functions of the VP-418xl Video to HDMI Scaler | 5 |
| Table 2: | Technical Specifications of the VP-418xl Video to HDMI Scaler | 8 |

1 Introduction

Welcome to Kramer Electronics! Since 1981, Kramer Electronics has been providing a world of unique, creative, and affordable solutions to the vast range of problems that confront the video, audio, presentation, and broadcasting professional on a daily basis. In recent years, we have redesigned and upgraded most of our line, making the best even better! Our 1,000-plus different models now appear in 11 groups¹ that are clearly defined by function.

Congratulations on purchasing your Kramer **VP-418xl Video to HDMI Scaler**. This product is ideal for:

- Projection systems in conference rooms, boardrooms, hotels and churches
- Home theater up-scaling

The package includes the following items:

- **VP-418xl Video to HDMI Scaler**
- Power adapter (5V DC input)
- This user manual²

2 Getting Started

We recommend that you:

- Unpack the equipment carefully and save the original box and packaging materials for possible future shipment
- Review the contents of this user manual
- Use Kramer high performance high resolution cables³

2.1 Quick Start

This quick start chart summarizes the basic setup and operation steps.

1 GROUP 1: Distribution Amplifiers; GROUP 2: Switchers and Matrix Switchers; GROUP 3: Control Systems; GROUP 4: Format/Standards Converters; GROUP 5: Range Extenders and Repeaters; GROUP 6: Specialty AV Products; GROUP 7: Scan Converters and Scalers; GROUP 8: Cables and Connectors; GROUP 9: Room Connectivity; GROUP 10: Accessories and Rack Adapters; GROUP 11: Sierra Products

2 Download up-to-date Kramer user manuals from the Internet at this URL: <http://www.kramerelectronics.com>

3 The complete list of Kramer cables is on our Web site at <http://www.kramerelectronics.com>

Step 1: Connect the input and the outputs - see section 5

- 1 Connect the video and the audio signals of an s-Video Camcorder to the Y/C input.
- 2 Connect the video and the audio signals of a DVD player to the CV input.
- 3 Connect the HDMI output to a plasma display.

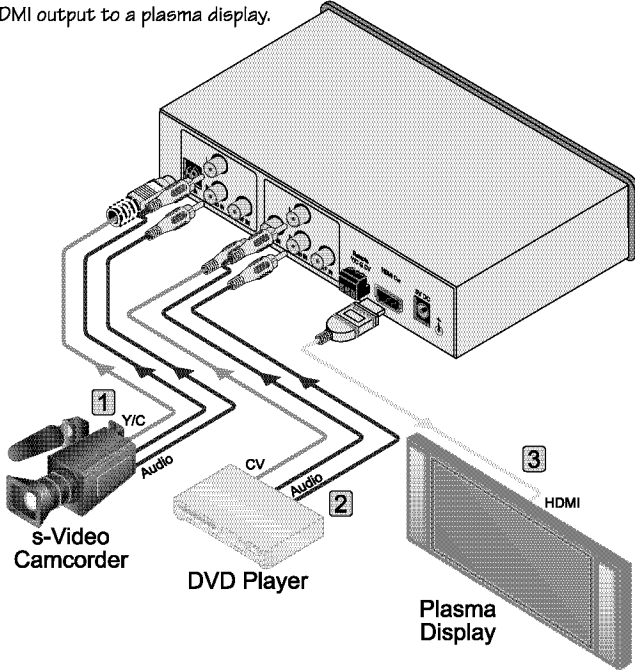

Step 2: Connect the power

Step 3: Operate the machine - see section 5

Select the input signal via the Input button

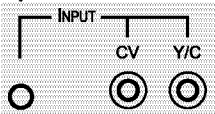

Select the output resolution via the Resolution button

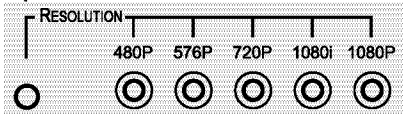

Switch between inputs by momentarily connecting the appropriate input (Y/C or CV) to the G (Ground) PIN
DO NOT connect more than one PIN to the G PIN at the same time

3 Overview

The Kramer **VP-418xl** is a high quality video to HDMI scaler. It accepts one of two inputs: either s-Video on a 4-pin connector, or composite video on an RCA connector (selected via a front panel selector button or via the remote contact closure connector), as well as their corresponding sets of digital audio (S/PDIF) or analog unbalanced stereo audio signals on RCA connectors. It scales the video, embeds the audio, and outputs the signal to the HDMI output.

The **VP-418xl** *Video to HDMI Scaler*:

- Is HDTV compatible and the resolution can be scaled up to 480p, 576p, 720p, 1080i or 1080p via a front panel selector button
- Has both analog and digital (S/PDIF) audio inputs for each video input
- Automatically detects and selects the analog/digital audio source. Default selection is S/PDIF – if this is not present, then the machine uses the audio from the analog inputs
- Has a non-volatile memory that retains the last settings used
- Is housed in a desktop sized enclosure and is 5V DC fed

Control your **VP-418xl**:

- Directly, via the front panel push buttons
- Remotely, from the remote contact closure connector

3.1 About HDMI

High-Definition Multimedia Interface (HDMI) is an uncompressed all-digital¹ audio/video interface, widely supported in the entertainment and home cinema industry. It delivers the highest high-definition image and sound quality.

In particular, HDMI²:

- Provides a simple³ interface between any audio/video source, such as a set-top box, DVD player, or A/V receiver and video monitor, such as a digital flat LCD / plasma television (DTV), over a single lengthy⁴ cable

1 Ensuring an all-digital rendering of video without the losses associated with analog interfaces and their unnecessary digital-to-analog conversions

2 HDMI, the HDMI logo and High-Definition Multimedia Interface are trademarks or registered trademarks of HDMI licensing LLC

3 With video and multi-channel audio combined into a single cable, the cost, complexity, and confusion of multiple cables currently used in A/V systems is reduced

4 HDMI technology has been designed to use standard copper cable construction at up to 15m

- Supports standard, enhanced, high-definition video, and multi-channel digital audio¹ on a single cable
- Transmits all ATSC HDTV standards and supports 8-channel digital audio, with bandwidth to spare to accommodate future enhancements and requirements
- Benefits consumers by providing superior, uncompressed digital video quality via a single cable², and user-friendly connector
- Is backward-compatible with DVI (Digital Visual Interface)
- Supports two-way communication between the video source (such as a DVD player) and the digital television, enabling new functionality such as automatic configuration and one-button play

HDMI has the capacity to support:

- Existing high-definition video formats (720p, 1080i, and 1080p/60), as well as standard definition formats such as NTSC or PAL

3.2 Recommendations for Best Performance

To achieve the best performance:

- Connect only good quality connection cables, thus avoiding interference, deterioration in signal quality due to poor matching, and elevated noise-levels (often associated with low quality cables)
- Avoid interference from neighboring electrical appliances and position your Kramer **VP-418xl** away from moisture, excessive sunlight and dust



Caution – No operator-serviceable parts inside unit.

Warning – Use only the Kramer Electronics input power wall adapter that is provided with this unit³.

Warning – Disconnect power and unplug unit from wall before installing or removing device or servicing unit.

¹ HDMI supports multiple audio formats, from standard stereo to multi-channel surround-sound. HDMI has the capacity to support Dolby 5.1 audio and high-resolution audio formats

² HDMI provides the quality and functionality of a digital interface while also supporting uncompressed video formats in a simple, cost-effective manner

³ For example, part number 2535-052002

4 Your VP-418xl Video to HDMI Scaler

Figure 1 and Table 1 define the **VP-418xl Video to HDMI Scaler**:

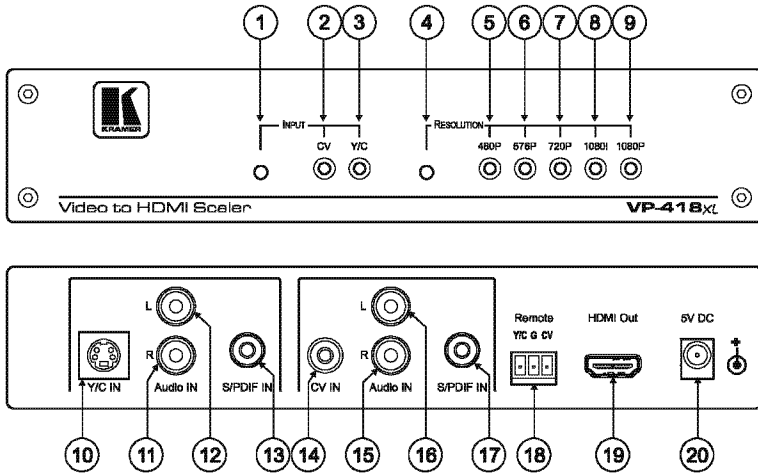

Figure 1: VP-418xl Video to HDMI Scaler

Table 1: Features and Functions of the VP-418xl Video to HDMI Scaler

| # | | Feature | Function |
|----|------------|------------------------------|---|
| 1 | INPUT | Selector Button ¹ | Press ² to select the CV input or the Y/C input |
| 2 | | CV Indicator LED | Lights when the CV input is selected |
| 3 | | Y/C Indicator LED | Lights when the Y/C input is selected |
| 4 | RESOLUTION | Selector Button | Press ² to select the resolution: 480p, 576p, 720p, 1080i or 1080p |
| 5 | | 480p Indicator LED | Lights when the 480p resolution is selected |
| 6 | | 576p Indicator LED | Lights when the 576p resolution is selected |
| 7 | | 720p Indicator LED | Lights when the 720p resolution is selected |
| 8 | | 1080i Indicator LED | Lights when the 1080i resolution is selected |
| 9 | | 1080p Indicator LED | Lights when the 1080p resolution is selected |
| 10 | Y/C | Y/C IN 4-pin Connector | Connect to the s-Video source |
| 11 | | Audio IN RCA Connector | R L Connect to the right and left analog unbalanced stereo audio source (of the Y/C source) |
| 12 | | S/PDIF IN RCA Connector | |
| 13 | CV | CV IN RCA Connector | Connect to the composite video source |
| 14 | | Audio IN RCA Connector | R L Connect to the right and left analog unbalanced stereo audio source (of the CV source) |
| 15 | | Audio IN RCA Connector | |
| 16 | | S/PDIF IN RCA Connector | Connect to the digital audio source (of the CV source) |
| 17 | | Remote Terminal Block | Connects to a contact closure switch (see section 5.1) |
| 18 | | HDMI Out Connector | Connects to the HDMI acceptor |
| 19 | | 5V DC | +5V DC connector for powering the unit |

1 Push in the selector button, using a small screwdriver

2 Pressing will scroll to the next selection

5 Connecting the VP-418xl Video to HDMI Scaler

To connect your **VP-418xl**, as the example in Figure 2 illustrates¹, do the following²:

1. Connect an s-Video source (for example, an s-Video camcorder) to the Y/C IN 4-pin connector.
2. Connect the analog unbalanced stereo audio signal of the s-video source to the L and R RCA connectors in the Y/C area³.
3. Connect a composite video source (for example, a DVD player) to the CV IN RCA connector.
4. Connect the analog unbalanced stereo audio signal of the CV source to the L and R RCA connectors in the CV area³.
5. Connect the HDMI Out connector to an HDMI acceptor⁴ (for example, a plasma display).
6. Connect the 5V DC power adapter to the power socket and connect the adapter to the mains electricity (not shown in Figure 2).

¹ You do not have to connect both inputs

² Switch OFF the power on each device before connecting it to your VP-418xl. After connecting your VP-418xl, switch on its power and then switch on the power on each device

³ Alternatively, you can connect the digital audio source to the S/PDIF RCA connector

⁴ After connecting the power, if required, press the RESOLUTION button to set the scaled output resolution

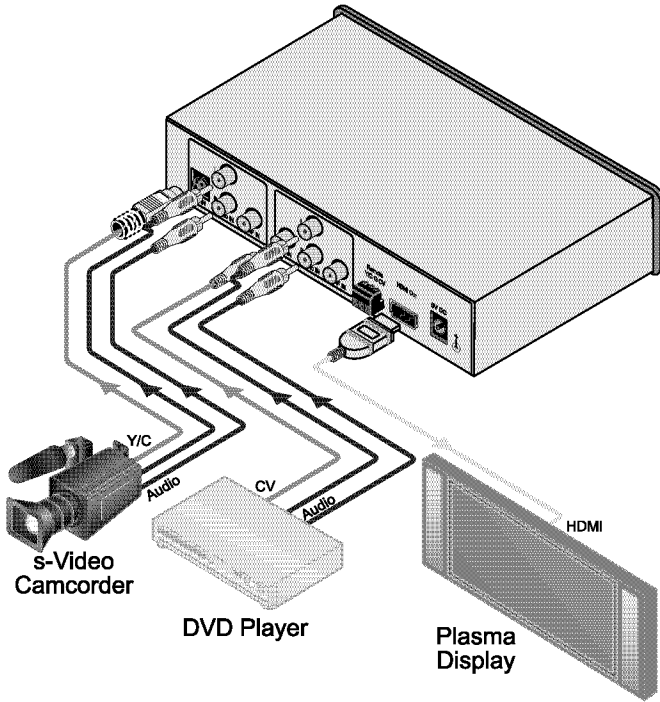

Figure 2: Connecting the VP-418xl Video to HDMI Scaler

5.1 Connecting the Contact Closure Remote Control PINs

The contact closure remote control pins operate in a similar way to the Input selector button. Using the contact closure remote control you can select the Y/C or the CV input. To do so, connect the required input¹ pin on the REMOTE terminal block connector to the G (Ground) pin, as Figure 3 illustrates.

DO NOT Connect more than one PIN to the Ground PIN at the same time

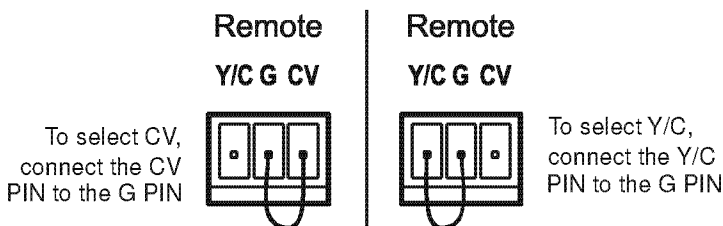

Figure 3: Connecting the Contact Closure Remote Control PINs

6 Technical Specifications

Table 2: Technical Specifications² of the VP-418xl Video to HDMI Scaler

| | |
|----------------------|---|
| INPUTS: | 1 CV on an RCA connector 1Vpp/75Ω 1 s-Video on a 4-pin connector 1Vpp/75Ω (Y); 0.3Vpp/75Ω (C) 2 analog unbalanced stereo audio (left and right) on RCA connectors, 1 Vpp/24kΩ 2 S/PDIF digital audio on RCA connectors |
| OUTPUT: | 1 HDMI connector (HDMI version 1.2, HDCP version 1.1) |
| OUTPUT RESOLUTIONS: | 480p ³ , 576p ⁴ , 720p, 1080i, 1080p |
| OUTPUT REFRESH RATE: | 50/60Hz ⁵ |
| CONTROLS: | Input selector button, resolution selector button, contact closure |
| POWER SOURCE: | 5VDC, 700mA @ 1080i/1080p |
| DIMENSIONS: | 21.46cm x 16.25cm x 4.36cm (8.45" x 6.4" x 1.72") W, D, H |
| WEIGHT: | 1.1kg (2.4lb) approx. |
| ACCESSORIES: | Power supply |
| OPTIONS: | Rack adapter |

¹ Y/C or CV

² Specifications are subject to change without notice

³ For NTSC input only

⁴ For PAL input only

⁵ Follows input

LIMITED WARRANTY

Kramer Electronics (hereafter *Kramer*) warrants this product free from defects in material and workmanship under the following terms.

HOW LONG IS THE WARRANTY

Labor and parts are warranted for seven years from the date of the first customer purchase.

WHO IS PROTECTED?

Only the first purchase customer may enforce this warranty.

WHAT IS COVERED AND WHAT IS NOT COVERED

Except as below, this warranty covers all defects in material or workmanship in this product. The following are not covered by the warranty:

1. Any product which is not distributed by Kramer, or which is not purchased from an authorized Kramer dealer. If you are uncertain as to whether a dealer is authorized, please contact Kramer at one of the agents listed in the Web site www.kramerelectronics.com.
2. Any product, on which the serial number has been defaced, modified or removed, or on which the WARRANTY VOID IF TAMPERED sticker has been torn, reattached, removed or otherwise interfered with.
3. Damage, deterioration or malfunction resulting from:
 - i) Accident, misuse, abuse, neglect, fire, water, lightning or other acts of nature
 - ii) Product modification, or failure to follow instructions supplied with the product
 - iii) Repair or attempted repair by anyone not authorized by Kramer
 - iv) Any shipment of the product (claims must be presented to the carrier)
 - v) Removal or installation of the product
 - vi) Any other cause, which does not relate to a product defect
 - vii) Cartons, equipment enclosures, cables or accessories used in conjunction with the product

WHAT WE WILL PAY FOR AND WHAT WE WILL NOT PAY FOR

We will pay labor and material expenses for covered items. We will not pay for the following:

1. Removal or installations charges.
2. Costs of initial technical adjustments (set-up), including adjustment of user controls or programming. These costs are the responsibility of the Kramer dealer from whom the product was purchased.
3. Shipping charges.

HOW YOU CAN GET WARRANTY SERVICE

1. To obtain service on you product, you must take or ship it prepaid to any authorized Kramer service center.
2. Whenever warranty service is required, the original dated invoice (or a copy) must be presented as proof of warranty coverage, and should be included in any shipment of the product. Please also include in any mailing a contact name, company, address, and a description of the problem(s).
3. For the name of the nearest Kramer authorized service center, consult your authorized dealer.

LIMITATION OF IMPLIED WARRANTIES

All implied warranties, including warranties of merchantability and fitness for a particular purpose, are limited in duration to the length of this warranty.

EXCLUSION OF DAMAGES

The liability of Kramer for any effective products is limited to the repair or replacement of the product at our option. Kramer shall not be liable for:

1. Damage to other property caused by defects in this product, damages based upon inconvenience, loss of use of the product, loss of time, commercial loss; or:
2. Any other damages, whether incidental, consequential or otherwise. Some countries may not allow limitations on how long an implied warranty lasts and/or do not allow the exclusion or limitation of incidental or consequential damages, so the above limitations and exclusions may not apply to you.

This warranty gives you specific legal rights, and you may also have other rights, which vary from place to place.

NOTE: All products returned to Kramer for service must have prior approval. This may be obtained from your dealer.

This equipment has been tested to determine compliance with the requirements of:

- EN-50081: "Electromagnetic compatibility (EMC);
generic emission standard.
Part 1: Residential, commercial and light industry"
- EN-50082: "Electromagnetic compatibility (EMC) generic immunity standard.
Part 1: Residential, commercial and light industry environment".
- CFR-47: FCC® Rules and Regulations:
Part 15: "Radio frequency devices
Subpart B Unintentional radiators"

CAUTION!

- Servicing the machines can only be done by an authorized Kramer technician. Any user who makes changes or modifications to the unit without the expressed approval of the manufacturer will void user authority to operate the equipment.
- Use the supplied DC power supply to feed power to the machine.
- Please use recommended interconnection cables to connect the machine to other components.
* FCC and CE approved using STP cable (for twisted pair products)





For the latest information on our products and a list of Kramer distributors, visit our Web site: www.kramerelectronics.com, where updates to this user manual may be found. We welcome your questions, comments and feedback.



Caution

Safety Warning:

Disconnect the unit from the power supply before opening/servicing.



Kramer Electronics, Ltd.

Web site: www.kramerelectronics.com

E-mail: info@kramerel.com

P/N: 2900-000507 REV 1