



KRAMER ELECTRONICS LTD.

# USER MANUAL

MODEL:

**VP-4x4K**  
4x4 UXGA/Audio Matrix  
Switcher

---

P/N: 2900-000386 Rev 7



# VP-4x4K Quick Start Guide

This guide helps you install and use your product for the first time. For more detailed information, go to <http://www.kramerav.com/manual/VP-4x4K> to download the latest manual or scan the QR code on the left.

## Step 1: Check what's in the box

- ✓ **VP-4x4K** 4x4 UXGA/Audio Matrix Switcher
- ✓ 1 Power cord
- ✓ 1 Set of rack "ears"
- ✓ Kramer RC-IR3 Infrared Remote Control Transmitter with batteries and user manual
- ✓ 4 Rubber feet
- ✓ 1 Quick Start sheet

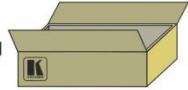

Save the original box and packaging in case your product needs to be returned to the factory for service.

## Step 2: Install the VP-4x4K

Mount the machine in a rack (using the included rack "ears") or attach the rubber feet and place on a table.

## Step 3: Connect the inputs and outputs

Always switch off the power on each device before connecting it to your VP-4x4K.

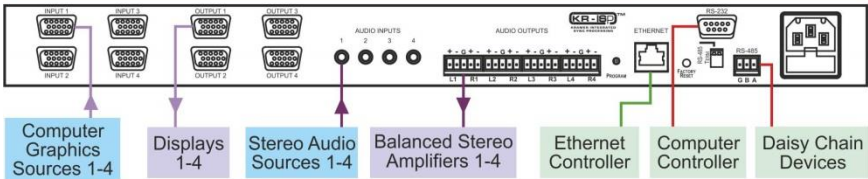

Always use Kramer high-performance cables for connecting AV equipment to the VP-4x4K.

## Step 4: Connect the power

Connect the power cord to the VP-4x4K and plug into the mains electricity.



## Step 5: Operate the VP-4x4K

Set the parameters using the OSD and the front panel buttons.

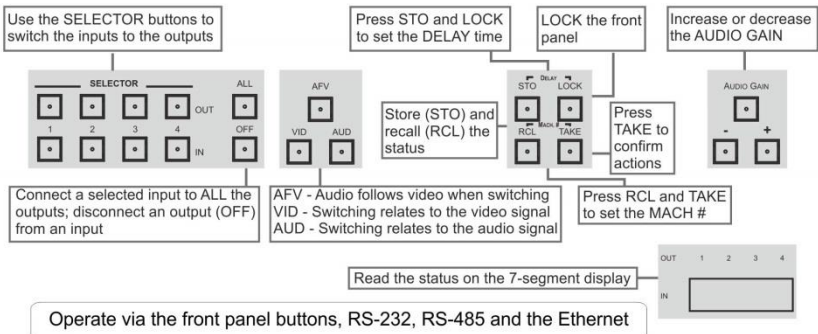

Operate via the front panel buttons, RS-232, RS-485 and the Ethernet

# Contents

<b>1</b>	<b>Introduction</b>	<b>1</b>
<b>2</b>	<b>Getting Started</b>	<b>2</b>
2.1	Achieving the Best Performance	2
<b>3</b>	<b>Overview</b>	<b>3</b>
3.1	Defining the VP-4x4K 4x4 UXGA/Audio Matrix Switcher	4
<b>4</b>	<b>Installing in a Rack</b>	<b>7</b>
<b>5</b>	<b>Connecting the VP-4x4K</b>	<b>8</b>
5.1	Connecting the VP-4x4K Rear Panel	8
5.2	Connecting the Balanced/Unbalanced Stereo Audio Output	10
5.3	Connecting to the VP-4x4K via RS-232	10
5.4	Cascading Machines	11
5.5	Configuring the Ethernet Port	12
5.6	DIP-switch Settings	16
<b>6</b>	<b>Operating Your Audio Matrix Switcher</b>	<b>17</b>
6.1	Displaying Unit Characteristics	17
6.2	Adjusting the Audio Gain	18
6.3	Setting the Switching Delay Time	19
6.4	Setting the Machine Number	20
6.5	Choosing the Audio-Follow-Video or Breakaway Option	20
6.6	Switching OUT-IN Combinations	21
6.7	Confirming Settings	22
6.8	Storing/Recalling Input/Output Configurations	24
6.9	Locking the Front Panel	25
<b>7</b>	<b>Flash Memory Upgrade</b>	<b>26</b>
<b>8</b>	<b>Controlling via the Embedded Web Pages</b>	<b>27</b>
8.1	Connecting to the VP-4x4K via your Browser	27
8.2	The VP-4x4K Switching Matrix Page	29
8.3	Audio Gain Page	34
8.4	The CONFIGURATIONS Page	34
<b>9</b>	<b>Communication Parameters</b>	<b>36</b>
<b>10</b>	<b>Technical Specifications</b>	<b>37</b>
<b>11</b>	<b>Table of ASCII Codes for Serial Communication (Protocol 3000)</b>	<b>38</b>
<b>12</b>	<b>Hex Codes for Serial Communication (Protocol 2000)</b>	<b>40</b>
<b>13</b>	<b>Kramer Protocol</b>	<b>42</b>
13.1	Switching Protocols	42
13.2	Kramer Protocol 3000	43
13.3	Kramer Protocol 2000	52

# Figures

Figure 1: VP-4x4K 4x4 UXGA/Audio Matrix Switcher	4
Figure 2: Connecting the VP-4x4K 4x4 UXGA/Audio Matrix Switcher	9
Figure 3: Connecting the Balanced Stereo Audio Output	10
Figure 4: Connecting the Unbalanced Stereo Audio Output	10
Figure 5: Control Configuration via RS-232 and RS-485	12
Figure 6: Local Area Connection Properties Window	13
Figure 7: Internet Protocol (TCP/IP) Properties Window	14
Figure 8: Connect Screen	15
Figure 9: Device Properties Screen	16
Figure 10: VP-4x4K DIP-Switches	16
Figure 11: SELECTOR Buttons	24
Figure 12: Java Test Page Success Message	27
Figure 13: Entering the IP Number in the Address Bar	28
Figure 14: Loading the Embedded Web Pages	28
Figure 15: First Time Security Warning	28
Figure 16: VP-4x4K Embedded Web Page	29
Figure 17: Switching an Input to an Output	30
Figure 18: Switching an Input to an Output	31
Figure 19: Exiting Offline Warning	31
Figure 20: Selecting a preset	32
Figure 21: Save Preset Message	32
Figure 22: Load Preset Message	33
Figure 23: Recalling a Preset in the Confirm Mode	33
Figure 24: Audio Gain Page	34
Figure 25: CONFIGURATIONS Embedded Web Page	35

---

# 1 Introduction

Welcome to Kramer Electronics! Since 1981, Kramer Electronics has been providing a world of unique, creative, and affordable solutions to the vast range of problems that confront the video, audio, presentation, and broadcasting professional on a daily basis. In recent years, we have redesigned and upgraded most of our line, making the best even better!

Our 1,000-plus different models now appear in 14 groups that are clearly defined by function: GROUP 1: Distribution Amplifiers; GROUP 2: Switchers and Routers; GROUP 3: Control Systems; GROUP 4: Format/Standards Converters; GROUP 5: Range Extenders and Repeaters; GROUP 6: Specialty AV Products; GROUP 7: Scan Converters and Scalers; GROUP 8: Cables and Connectors; GROUP 9: Room Connectivity; GROUP 10: Accessories and Rack Adapters; GROUP 11: Sierra Video Products; GROUP 12: Digital Signage; GROUP 13: Audio; and GROUP 14: Collaboration.

Congratulations on purchasing your Kramer **VP-4x4K** 4x4 *UXGA/Audio Matrix Switcher*, which is ideal for the following typical applications:

- Professional display systems requiring true 4x4 matrix operation
- Multimedia and presentation source and acceptor selection
- Remote monitoring of computer activity in schools and businesses
- Rental/staging applications

---

## 2 Getting Started

We recommend that you:

- Unpack the equipment carefully and save the original box and packaging materials for possible future shipment
- Review the contents of this user manual
  - Use Kramer high performance high resolution cables
  - Use only the power cord that is supplied with this machine



Go to <http://www.kramerelectronics.com> to check for up-to-date user manuals, application programs, and to check if firmware upgrades are available (where appropriate).

### 2.1 Safety Instructions



**Caution:** There are no operator serviceable parts inside the unit

**Warning:** Use only the power cord that is supplied with the unit

**Warning:** Do not open the unit. High voltages can cause electrical shock! Servicing by qualified personnel only

**Warning:** In case of static electricity discharge, the device may freeze and require restarting. The product then returns to normal operation in its pre-freeze state

### 2.2 Achieving the Best Performance

To achieve the best performance:

- Use only good quality connection cables to avoid interference, deterioration in signal quality due to poor matching, and elevated noise levels (often associated with low quality cables)
- Avoid interference from neighboring electrical appliances that may adversely influence signal quality
- Position your Kramer **VP-4x4K** away from moisture, excessive sunlight and dust

---

## 3 Overview

The **VP-4x4K** is a true 4x4 matrix switcher for computer graphics (up to and exceeding UXGA) signals and balanced stereo audio signals. The **VP-4x4K** lets you simultaneously route any or all of the four inputs to any or all of the four outputs.

In addition, the **VP-4x4K** features:

- A video bandwidth of 400MHz that ensures transparent UXGA performance
- DC coupled inputs and outputs
- A selectable delayed switching mode (ranging from 0 to 3.5sec, in increments of 0.5sec) for clean transitions (seamless switching) when switching between non-genlocked sources
- Audio gain control for the inputs and the outputs
- Audio-follow-video and breakaway options
- Storing and recalling setup options
- A TAKE button for precise switch control that lets you execute multiple switches all at once
- A LOCK button to prevent tampering with the front panel
- The ability to automatically detect connected input signals (the respective button illuminates in green)
- Our innovative integrated sync processing; KRISP™ technology that lets you achieve a sharp, stable image when the sync level is too low, by restoring the sync signal waveform

Control the **VP-4x4K** using the front panel buttons, or remotely via:

- RS-485 or RS-232 serial commands transmitted by a touch screen system, PC, or other serial controller
- The Kramer **RC-IR3** infrared remote control transmitter
- The Ethernet

### 3.1 Defining the VP-4x4K 4x4 UXGA/Audio Matrix Switcher

This section defines the **VP-4x4K**.

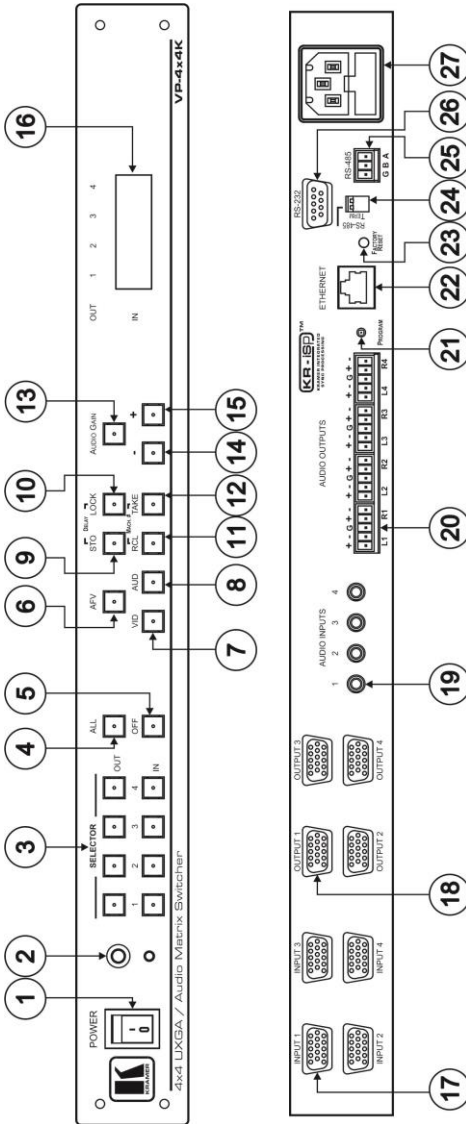

Figure 1: VP-4x4K 4x4 UXGA/Audio Matrix Switcher



#	Feature	Function	
1	<i>POWER</i> Switch	Illuminated switch for turning the unit ON or OFF	
2	IR Receiver	Signals from the remote control transmitter illuminate the LED	
3	<i>SELECTOR</i> Buttons	<i>OUT</i>	Select the output to which the input is switched
		<i>IN</i>	Select the input to switch to the output When a signal is detected, the input button illuminates in green  The <i>SELECTOR IN</i> and <i>OUT</i> buttons also store/recall the input/output configurations (see <a href="#">Section 6.8</a> )
4	<i>ALL</i> Button	Pressing <i>ALL</i> before pressing an input button connects that input to all outputs  For example, press <i>ALL</i> and then Input button # 2 to connect input # 2 to all the outputs	
5	<i>OFF</i> Button	Pressing <i>OFF</i> after pressing an output button disconnects that output from the inputs. To disconnect all the outputs, press the <i>ALL</i> button and then the <i>OFF</i> button	
6	<i>AFV</i> Button	When illuminated, the audio channels follow the video channels. The button is illuminated when the <i>AFV</i> mode is selected  If the <i>AUDIO</i> differs from the <i>VIDEO</i> , the <i>TAKE</i> button will flash, and you have to press the <i>TAKE</i> button to confirm the modification	
7	<i>VID</i> Button	When illuminated, actions relate to video  The <i>VID</i> button is illuminated when in breakaway mode and actions relate to video	
8	<i>AUD</i> Button	When illuminated, actions relate to audio  The <i>AUD</i> button is illuminated when in breakaway mode and actions relate to audio	
9	<i>STO</i> Button	Pressing <i>STO</i> ( <i>STORE</i> ) followed by an output or an input button stores the current setting  Press the <i>STO</i> and <i>LOCK</i> buttons simultaneously to set the delay time (see <a href="#">Section 6.3</a> )  For example, press <i>STO</i> and then the Output button # 3 to store in Setup # 3	
10	<i>LOCK</i> Button	Disengages the front panel switches	
11	<i>RCL</i> Button	Pressing <i>RCL</i> ( <i>RECALL</i> ) followed by an output or an input button displays a stored setup	
12	<i>TAKE</i> Button	Pressing <i>TAKE</i> toggles the mode between the <i>CONFIRM</i> mode and the <i>AT ONCE</i> mode (user confirmation per action is unnecessary). When in <i>CONFIRM</i> mode, actions are confirmed by pressing the <i>TAKE</i> key  For example, press <i>STO</i> and then the Output button # 3 to store in Setup # 3  When in the <i>CONFIRM</i> mode, the <i>TAKE</i> button illuminates	
13	<i>AUDIO GAIN</i> Button	Press to adjust the audio input or output gain (see <a href="#">Section 6.2</a> )	
14	- Button	Press to decrease the numerical value  By pressing the + or - buttons continuously, you can speed up their response. For step-by-step response, press and release these buttons as many times as needed  Gain, switching delay time and machine number	

#	Feature	Function
15	+ Button	Press to increase the numerical value
16	<i>STATUS</i> 7-segment Display	Displays the selected input switched to the output (marked above each input)  Also displays the number of IN and OUT ports, the firmware version number, the MACHINE # and the audio gain level. Refer to <a href="#">Section 6.1</a>
17	<i>INPUT</i> 15-pin HD Connectors	Connect to the video sources (from 1 to 4)
18	<i>OUTPUT</i> 15-pin HD Connectors	Connect to the acceptors (from 1 to 4)
19	<i>AUDIO INPUTS</i> 3.5mm Mini Plug Connectors	Connect to the unbalanced stereo audio sources (from 1 to 4)
20	<i>AUDIO OUTPUTS</i> Terminal block connectors	Connect to the balanced stereo audio acceptors (from 1 to 4)
21	<i>PROGRAM</i> Button	Not used (for technical staff use only)
22	<i>Ethernet</i> Connector	Connects to the PC or other Serial Controller through computer networking
23	<i>Factory Reset</i> Button	Press to reset to the factory default definitions: IP number – 192.168.1.39 Mask – 255.255.0.0 Gateway – 0.0.0.0 UDP port – 50000 TCP port – 5000 Protocol 3000 commands All 8 Presets deleted All audio channels set to 0dB Machine name – the last four digits of the machine's serial number DHCP disabled  Turn the POWER switch OFF and then ON again while pressing the Factory Reset button. The unit will power up and load its memory with the factory default definitions
24	<i>RS-485 TERM</i> DIP-switch	DIP 1 is for RS-485 Termination, DIP 2 is not used
25	<i>RS-485</i> Terminal Block Port	Pins B (-) and A (+) are for RS-485; Pin G (Ground) may be connected to the shield of the cable if desired
26	<i>RS-232</i> 9-pin D-sub Connector	Connects to the PC or the Remote Controller
27	Power Connector with Fuse	AC connector enabling power supply to the unit

## 4 Installing in a Rack

This section provides instructions for rack mounting the unit.

**Before installing in a rack**, be sure that the environment is within the recommended range:

OPERATING TEMPERATURE:	0° to +40°C (32° to 104°F)
STORAGE TEMPERATURE:	-40° to +70°C (-40° to 158°F)
HUMIDITY:	10% to 90%, RHL non-condensing



### CAUTION!

When installing on a 19" rack, avoid hazards by taking care that:

1. It is located within the recommended environmental conditions, as the operating ambient temperature of a closed or multi unit rack assembly may exceed the room ambient temperature.
2. Once rack mounted, enough air will still flow around the machine.
3. The machine is placed straight in the correct horizontal position.
4. You do not overload the circuit(s). When connecting the machine to the supply circuit, overloading the circuits might have a detrimental effect on overcurrent protection and supply wiring. Refer to the appropriate nameplate ratings for information. For example, for fuse replacement, see the value printed on the product label.
5. The machine is earthed (grounded) in a reliable way and is connected only to an electricity socket with grounding. Pay particular attention to situations where electricity is supplied indirectly (when the power cord is not plugged directly into the socket in the wall), for example, when using an extension cable or a power strip, and that you use only the power cord that is supplied with the machine.

### To rack-mount a machine:

1. Attach both ear brackets to the machine. To do so, remove the screws from each side of the machine (3 on each side), and replace those screws through the ear brackets.

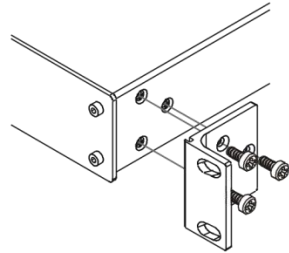

2. Place the ears of the machine against the rack rails, and insert the proper screws (not provided) through each of the four holes in the rack ears.

#### Note:

- In some models, the front panel may feature built-in rack ears
- Detachable rack ears can be removed for desktop use
- Always mount the machine in the rack before you attach any cables or connect the machine to the power
- If you are using a Kramer rack adapter kit (for a machine that is not 19"), see the Rack Adapters user manual for installation instructions available from our Web site

---

## 5 Connecting the VP-4x4K



Always switch off the power to each device before connecting it to your **VP-4x4K**. After connecting your **VP-4x4K**, connect its power and then switch on the power to each device.

This section describes how to:

- Connect the **VP-4x4K** rear panel (see [Section 5.1](#))
- Connect a balanced/unbalanced stereo audio output (see [Section 5.2](#))
- Connect the stereo audio output (see [Section 5.3](#))
- Connect several **VP-4x4K** machines (see [Section 5.4](#))
- Connect to the Ethernet (see [Section 5.5](#))
- Set the DIP-switches (see [Section 5.6](#))

### 5.1 Connecting the VP-4x4K Rear Panel

To connect the **VP-4x4K**, as illustrated in the example in [Figure 2](#), do the following:

1. Connect up to four computer graphics video sources to the 15-pin HD INPUT connectors (from INPUT 1 to INPUT 4).
2. Connect up to four unbalanced stereo audio sources (for example, the audio source of the computer) to the AUDIO INPUT 3.5mm mini-plug connectors (from 1 to 4).  
*Alternatively, you can connect a separate audio source (as shown for input 1 in [Figure 2](#)), or no source at all.*
3. Connect the four 15-pin HD OUTPUT connectors to up to four computer graphics video acceptors (for example, displays).
4. Connect the four AUDIO OUTPUT terminal block connectors to up to four balanced stereo audio acceptors (for example, balanced stereo audio amplifiers with speakers).  
*See [Section 5.2](#).*
5. Set the DIP-switches (see [Section 5.6](#)).

6. As an option, you can connect a PC and/or controller to the RS-232 port (see [Section 5.3](#)), the RS-485 port (see [Section 5.4](#)) and the Ethernet (see [Section 5.5](#)).
7. Connect the power cord.

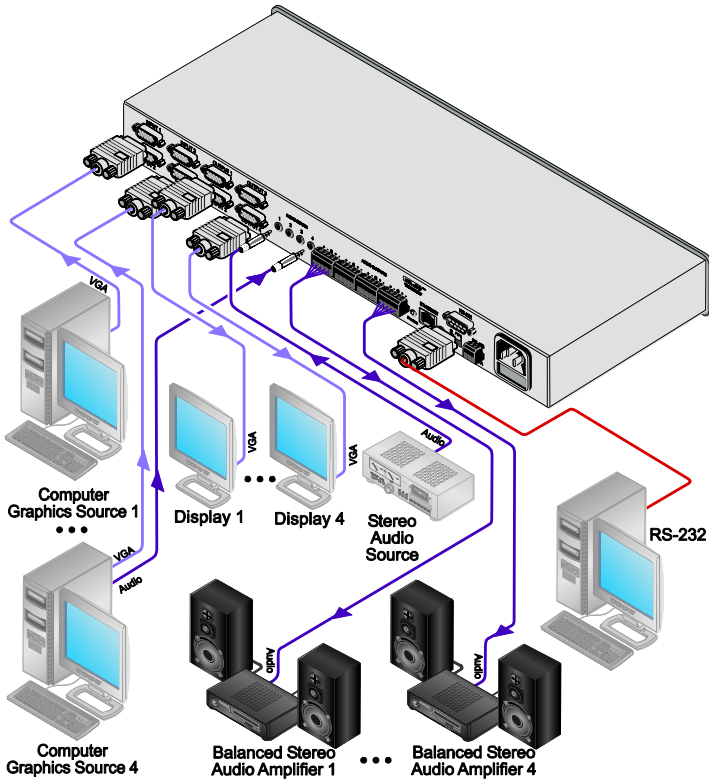

Figure 2: Connecting the VP-4x4K 4x4 UXGA/Audio Matrix Switcher

## 5.2 Connecting the Balanced/Unbalanced Stereo Audio Output

[Figure 3](#) illustrates how to connect a balanced stereo audio connection.

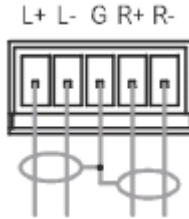

Figure 3: Connecting the Balanced Stereo Audio Output

[Figure 4](#) illustrates how to connect an unbalanced stereo audio connection.

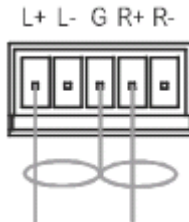

Figure 4: Connecting the Unbalanced Stereo Audio Output

## 5.3 Connecting to the VP-4x4K via RS-232

You can connect to the **VP-4x4K** via an RS-232 connection using, for example, a PC. Note that a null-modem adapter/connection is not required.

- To connect to the **VP-4x4K** via RS-232, connect the RS-232 9-pin D-sub rear panel port on the **VP-4x4K** unit via a 9-wire straight cable (pin 2 to pin 2, pin 3 to pin 3, pin 5 to pin 5) to the RS-232 9-pin D-sub port on your PC

## 5.4 Cascading Machines

You can cascade up to 16 **VP-4x4K** units with control from a PC or serial controller.

To cascade 16 individual **VP-4x4K** units via RS-485, as illustrated in the example in [Figure 5](#), do the following:

1. Connect the sources and acceptors (see [Section 5.1](#)).
2. Connect the RS-232 port of the first **VP-4x4K** unit to a PC.
3. Connect the RS-485 terminal block port on the first **VP-4x4K** unit to the RS-485 port on the second **VP-4x4K** unit and so on, connecting all the RS-485 ports.
4. Set the first **VP-4x4K** unit as Machine # 1 and the following **VP-4x4K** units as Machine # 2 to Machine # 16 (see [Section 6.4](#)).
5. On the first and last **VP-4x4K** units, set the RS-485 TERM DIP-switch to ON, terminating the RS-485 line at  $120\Omega$  (see [Section 5.6](#)), and set this DIP-switch to OFF on the other **VP-4x4K** units.

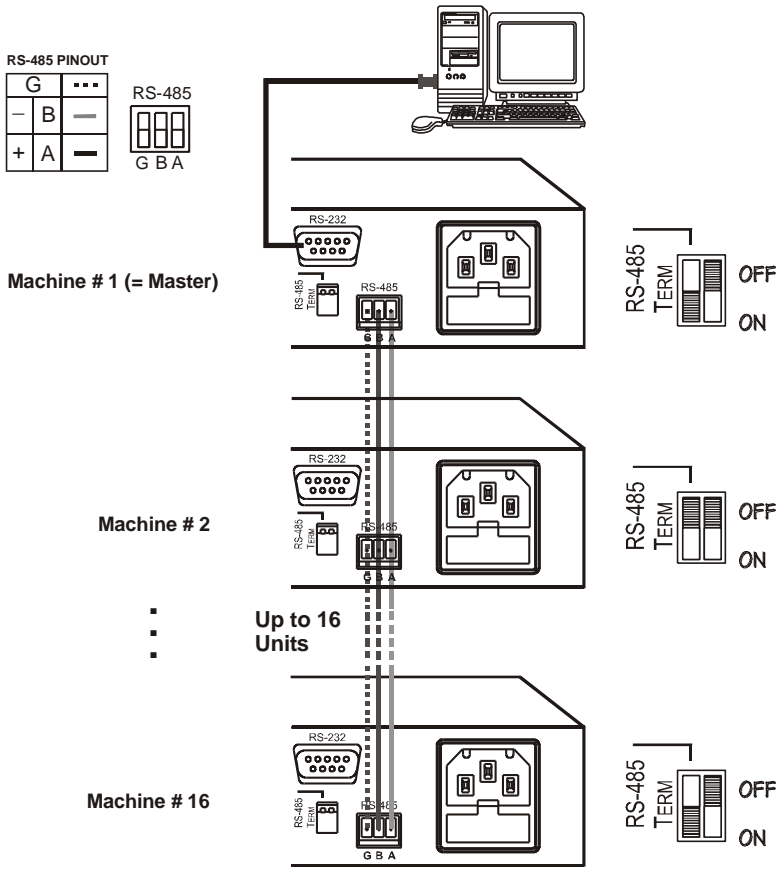

Figure 5: Control Configuration via RS-232 and RS-485

## 5.5 Configuring the Ethernet Port

To configure the Ethernet port, you have to connect your PC to the **VP-4x4K** either via the Ethernet or via a serial port (see [Section 5.3](#)). Once the machine is connected, you can configure the Ethernet port.

### 5.5.1 Connecting the Ethernet Port Directly to a PC (Crossover Cable)

You can connect the Ethernet port of the machine to the Ethernet port on your PC, via a crossover cable with RJ-45 connectors.





This type of connection is recommended for identification of the factory default IP Address of the **VP-4x4K** during the initial configuration. (The default IP address is 192.168.1.39).

After connecting the Ethernet port, configure your PC as follows:

1. Right-click the My Network Places icon on your desktop.
2. Select **Properties**.
3. Right-click Local Area Connection Properties.

4. Select **Properties**.

The Local Area Connection Properties window appears.

5. Select the Internet Protocol (TCP/IP) and click the **Properties** Button (see [Figure 6](#)).

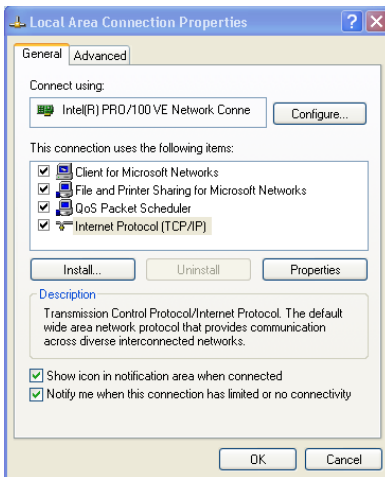

Figure 6: Local Area Connection Properties Window

6. Select Use the following IP Address, and fill in the details as shown in [Figure 7](#).
7. Click **OK**.

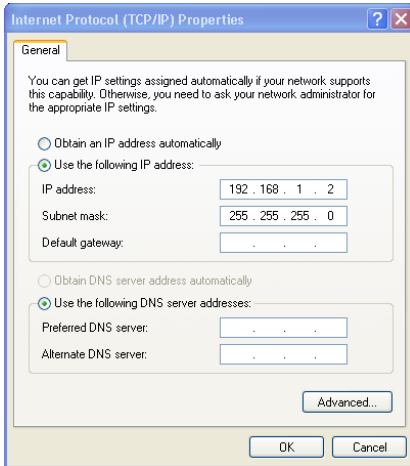

Figure 7: Internet Protocol (TCP/IP) Properties Window

## 5.5.2 Connecting the Ethernet Port via a Network Hub (Straight-Through Cable)

You can connect the Ethernet port of the **VP-4x4K** to the Ethernet port on a network hub or network router, via a straight-through cable with RJ-45 connectors.

## 5.5.3 Ethernet Port Configuration

To configure the Ethernet port, download the *Device Properties* Ethernet configuration software. Extract the file to a folder and create a shortcut on your desktop to the file.

Follow these steps to configure the port:

1. Double click the desktop icon.  
The Connect screen appears as follows:

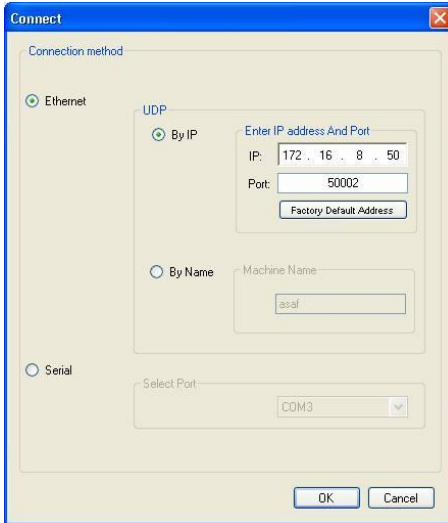

Figure 8: Connect Screen

2. Select the method to connect to the Ethernet port of the **VP-4x4K**.

Select:

- Ethernet, if you know the IP address number or the machine name.  
The default name for the machine is **KRAMER\_XXXX**  
The four digits are the last four digits of the machine's serial number.
- Serial, if you are connected via a serial port

3. Click OK.

The P3K Wizard window appears:

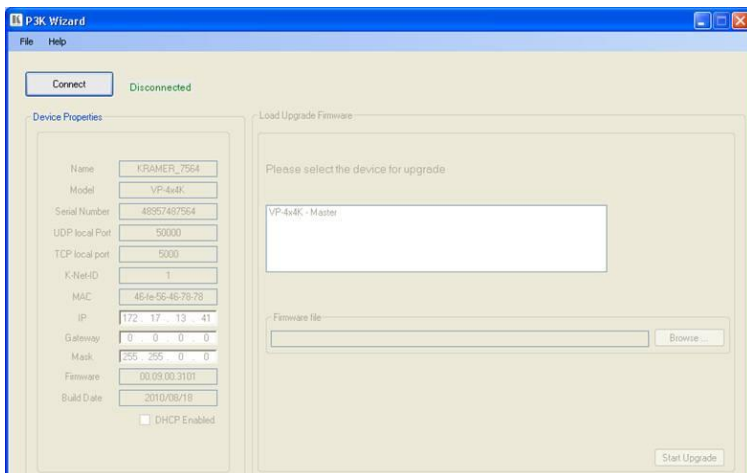

Figure 9: Device Properties Screen

4. If required, make changes and press Set. If not, click Close.

#### 5.5.4 Control via the Ethernet Port

If you were connected via the serial port, you need to connect to the master unit (Mach No. 1) via the Ethernet, as described in [Section 5.4](#).

### 5.6 DIP-switch Settings

The **VP-4x4K** includes two DIP-switches, as [Figure 10](#) defines. Only one of the DIP-switches is configured:

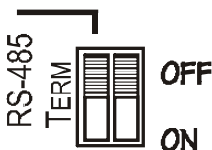

Function	Description
RS-485 TERM	ON for RS-485 line termination with 120Ω OFF for no RS-485 line termination  When cascading machines, set this DIP-switch to ON for the first and last units only (otherwise, set it to OFF)

Figure 10: VP-4x4K DIP-Switches

---



## 6 Operating Your Audio Matrix Switcher

This section describes how to operate the **VP-4x4K**. It explains how to:

- Use the 7-segment display (see [Section 6.1](#))
- Adjust the audio gain, see [Section 6.2](#)
- Set the switching delay time, see [Section 6.3](#)
- Set the machine number, see [Section 6.4](#)
- Choose the audio-follow-video or the break option, see [Section 6.5](#)
- Switch OUT-IN combinations, see [Section 6.6](#)
- Confirm settings, see [Section 6.7](#)
- Store and recall input/output configurations, see [Section 6.8](#)
- Lock the front panel buttons, see [Section 6.9](#)

### 6.1 Displaying Unit Characteristics

The 7-segment display shows several sets of information, as defined in the following examples:

The STATUS Display	Shows:	When:
<p>Initial Display</p> <p>OUT    1    2    3    4</p> <p>IN</p>  <p>Number 27.81 indicates the firmware version #</p>	<p>Unit characteristics: Firmware version</p>	<p>About 2 seconds (automatically) after switching on the power</p> <p>The STATUS shown here is an example of what could typically be displayed. The actual display depends on the current firmware version</p>
<p>Normal Display</p> <p>OUT    1    2    3    4</p> <p>IN</p>  <p>Audio inputs switched to the outputs</p>	<p>Normal display: Inputs switched to the outputs</p>	<p>During normal operation, appears a few seconds after the first display</p> <p>The STATUS shown here is an example of what could typically be displayed. The actual display depends on the current video and audio switching status</p>
<p>Audio Gain Display</p> <p>OUT    1    2    3    4</p> <p>IN</p>  <p>The audio gain level</p>	<p>Audio gain mode</p>	<p>After pressing the AUDIO GAIN button and selecting an output or an input</p> <p>The STATUS shown here is an example of what could typically be displayed. The actual display depends on the current audio gain level</p>

In addition, the 7-segment display shows the:

- Switching delay time when setting the delay time (see [Section 6.3](#))
- Selected machine number when setting the machine number (see [Section 6.4](#))

## 6.2 Adjusting the Audio Gain

You can adjust the audio gain for each input (from -100dB to +20dB) and output signal (from -100dB to +13dB).

To set the audio output gain, do the following:

When using the RC-IR3 remote controller you can only adjust the output volume. To adjust the volume of an output, press the VOL +/- key (to increase or decrease the volume respectively) and then the number of that output.

1. Press the AUDIO GAIN button on the front panel.
2. Press a SELECTOR OUT button to select the output for which you want to increase or decrease the gain.
3. Press the + or – buttons on the front panel to increase or decrease the gain, respectively.

To set the audio input gain, do the following:

1. Press and hold the SELECTOR IN button for which you want to increase or decrease the gain.
2. Press the + or – buttons on the front panel to increase or decrease the gain, respectively.

To exit the audio gain function, press any of the control buttons. If unused, this command times out after 20 seconds.



You can use the **RC-IR3** remote controller to adjust the output volume. To adjust the volume of an output, press the VOL +/- key (to increase or decrease the volume respectively) and then the number of that output

## 6.3 Setting the Switching Delay Time

You can achieve clean transitions when switching between non-genlocked sources by setting the delay time—ranging from 0sec to 3.5sec (in increments of 0.5sec)—via the DELAY DIP-switches. The **VP-4x4K** is shipped (its factory default state) with no delay, that is, the DELAY is set to 0sec.

To set the delay time, do the following:

1. Press the STO and LOCK front panel buttons simultaneously to access the DELAY mode.  
The 7-segment display shows the current switching delay time.
2. Use the + and – front panel buttons to set the delay time as required.

To confirm and exit the DELAY mode, press either the AUD, VID, or AFV button, the display shows the inputs switched to the outputs. If not confirmed, this command times out after 20 seconds.

## 6.4 Setting the Machine Number

The MACH. # (machine number) determines the position of a **VP-4x4K** unit when cascading units.

To set the MACH. #, do the following:

1. Press the front panel buttons: RCL and TAKE simultaneously to access the MACH. # mode.  
The 7-segment display shows the current machine number.
2. Use the + and – front panel buttons to set the machine number as required.

To confirm and exit the MACH. # mode, press either the AUD, VID or AFV buttons. If not confirmed, this command times out after 20 seconds.

## 6.5 Choosing the Audio-Follow-Video or Breakaway Option

You can switch stereo audio signals in one of two ways, either:

- Audio-follow-video (AFV), in which all operations and status indicators relate to both the video and the audio channels; or
- Breakaway, in which video and audio channels switch independently

If the audio differs from the video, then the TAKE button flashes. Also, the audio outputs, which will be changed, flashes in the status 7-segment display. Press the TAKE button to confirm the modification. The audio will follow the video. If not confirmed, this command times out after 20 seconds and the 7-segment display shows the audio configuration.

Warning that you are about to modify the audio configuration for AFV operation.



## 6.5.1 Setting the Audio-Follow-Video Option

To set the Audio-Follow-Video (AFV) option:

1. Press the AFV button.

The AFV button illuminates. The audio follows the video and the 7-segment display shows the video configuration.

If the audio configuration differs from the video configuration, the channels that differ flash, and require reconfiguring for AFV operation.

*Warning that changes are about to occur in the audio section.*

2. Press the TAKE button to confirm the modification (reconfiguring the audio according to the video).

## 6.5.2 Setting the Breakaway Option

To set the Breakaway option:

1. Press either the AUD (for audio control only) or the VID (for video control only) button.
2. If the AUD button illuminates, all switching operations relate to the Audio section.
3. If the VID button illuminates, all switching operations relate to the Video section.

## 6.6 Switching OUT-IN Combinations

To switch a video/audio input to a video/audio output, do the following:

1. Press an OUT button. (Either 1, 2, 3, 4 or ALL. To exit this command, press the OUT button again).

The corresponding Audio and/or Video IN STATUS 7-segment displays flash (when the audio-follow-video option is active (see [Section 6.5.1](#))).

By default, the OUT button selection times out after 10 minutes. You can press and hold the OUT button for about 2 seconds to have the OUT button selection remain until you select otherwise. (This operation practically cancels the 10 minute timeout.)

2. Press an IN button. (Either 1, 2, 3, 4 or OFF. If the IN button is not pressed within 20 seconds, this operation times out).

The selected input switches to the selected output.

For example, press the ALL button and then IN button # 2 to connect input # 2 to all the outputs.

## 6.7 Confirming Settings

Choose to work in the AT ONCE or the CONFIRM mode.

In the AT ONCE mode:

- You save time
- Actions require no user confirmation
- Execution is immediate
- No protection is offered against changing an action in error

In the CONFIRM mode:

- You have an optional method to help avoid making a mistake
- Every action requires user confirmation
- Execution is delayed until the user confirms the action (Failure to press the TAKE button within one minute (the Timeout) aborts the action)
- Protection is offered to prevent erroneous switching
- You can key-in several actions and then confirm them by pressing the TAKE button once, to simultaneously switch all monitors

Pressing an OUT-IN combination when your **VP-4x4K** operates in the AT ONCE mode implements the switch immediately. When the **VP-4x4K** operates in the CONFIRM mode, press the flashing TAKE button to authorize the switch.

### 6.7.1 Toggling between the AT ONCE and CONFIRM Modes

To toggle between the AT ONCE and CONFIRM modes, do the following:

1. Press the TAKE button to toggle from the AT ONCE mode (the TAKE button does not illuminate) to the CONFIRM mode (the TAKE button illuminates). Actions now require user confirmation and the TAKE button illuminates.
2. Press the illuminated TAKE button to toggle from the CONFIRM mode back to the AT ONCE mode. Actions no longer require user confirmation and the TAKE button no longer illuminates.

### 6.7.2 Confirming a Switching Action

To confirm a switching action (in CONFIRM mode), do the following:

1. Press an OUT-IN combination.  
The corresponding 7-segment display flashes. The TAKE button also flashes.
2. Press the flashing TAKE button to confirm the action.  
The corresponding 7-segment display no longer flashes. The TAKE button illuminates.

To confirm several actions (in CONFIRM mode), do the following:

1. Press each OUT-IN combination in sequence.  
The corresponding 7-segment display flashes. The TAKE button also flashes.
2. Press the flashing TAKE button to confirm all the actions.  
The corresponding 7-segment display no longer flashes. The TAKE button illuminates.

## 6.8 Storing/Recalling Input/Output Configurations

You can store and recall up to eight input/output setups using the four SELECTOR IN and the four SELECTOR OUT buttons, as [Figure 11](#) illustrates. For example, setup 2 is stored and can be recalled in OUT 1 and setup 7 is stored in IN 3.

The 8 input/output configurations (or setups) also include the relevant audio-follow-video/breakaway option definition.

When operating via the embedded Web page (see [Section 8](#)), RS-232 communication or the IR remote control transmitter, you can store/recall up to 16 setups.

The gray numbers (1 to 8) in [Figure 11](#) that illustrate the corresponding store/recall configuration number, are for the purpose of illustration only and do not actually appear on the buttons.

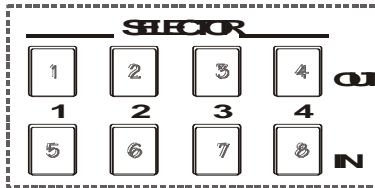

Figure 11: SELECTOR Buttons

### 6.8.1 Storing an Input/Output Configuration

To store the current status in memory, do the following:

1. Press the STO button.  
The STO button flashes.
2. Press one of the eight SELECTOR buttons.  
The memory stores the data at that reference.

### 6.8.2 Recalling an Input/Output Configuration

To recall an input/output configuration, do the following:

1. Press the RCL button.  
The RCL button flashes.
2. Press the appropriate SELECTOR button.  
The memory recalls the stored data from that reference.

If you cannot remember which of the eight input/output configurations is the one that you want, set the **VP-4x4K** to the CONFIRM mode and manually scan all the input/output configurations until you locate it.

### 6.8.3 Deleting an Input/Output Configuration

To delete an input/output configuration, do the following:

1. Press the STO and RCL buttons simultaneously.  
Both the STO and RCL buttons flash.
2. Press the appropriate SELECTOR button.  
This erases that specific input/output configuration from the memory, leaving it empty and available.  
Storing a new configuration over a previous configuration (without deleting it first) replaces the previous configuration.

## 6.9 Locking the Front Panel

To prevent changing the settings accidentally or tampering with the front panel, lock your **VP-4x4K**. Unlocking releases the protection mechanism.

To lock the **VP-4x4K**:

- Press the LOCK button for more than 2 seconds  
The LOCK button illuminates, freezing the front panel controls. Pressing a button will have no effect, except to cause the LOCK button to flash a warning that you need to unlock to regain control via the front panel.  
Nevertheless, even though the front panel is locked you can still operate your PC control software

To unlock the **VP-4x4K**:

- Press the illuminating LOCK button for more than 2 seconds  
The **VP-4x4K** unlocks and the LOCK button no longer illuminates

---

## 7 Flash Memory Upgrade

The **VP4x4K** uses a microcontroller that runs firmware located in FLASH memory.

The latest version of firmware and installation instructions can be downloaded from the Kramer Web site at [www.kramerelectronics.com](http://www.kramerelectronics.com).

---

## 8 Controlling via the Embedded Web Pages

You can remotely operate the **VP-4x4K** using a Web browser via the Ethernet connection (see [Section 8.1](#)). To be able to do so, you must use a supported Web browser; Microsoft (V6.0 and higher), Chrome or Firefox (V3.0 and higher).

To check that Java is installed correctly and running, browse to:

<http://www.java.com/en/download/help/testvm.xml>

This page runs a test and displays a Java success (see [Figure 12](#)) or failure message.



Figure 12: Java Test Page Success Message

If you do not see the success message, follow the instructions on the page to:

- Load and enable Java
- Enable JavaScript in your browser

### 8.1 Connecting to the VP-4x4K via your Browser

Make sure that your PC is connected via a network to the **VP-4x4K** and do the following:

1. Open your Internet browser.

2. Enter the unit's IP number or name in the Address bar of your browser.  
If you are using DHCP, you have to enter the name.  
The default IP number is 192.168.1.39, and can be changed by the system integrator.



Figure 13: Entering the IP Number in the Address Bar

The following window appears:

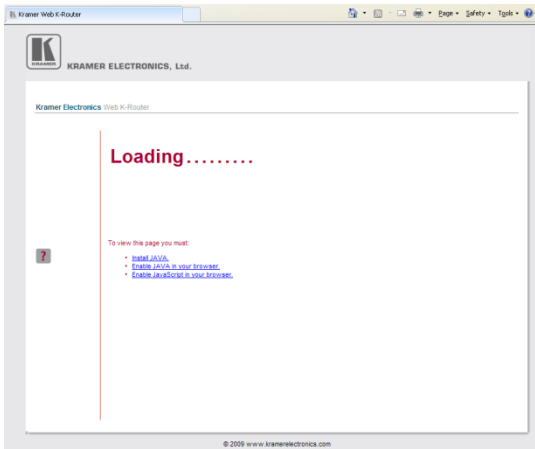

Figure 14: Loading the Embedded Web Pages

Check that Java and JavaScript is enabled in your browser. The following window appears:



Figure 15: First Time Security Warning

3. Click Run.

The **VP-4x4K** switching control page is displayed (see [Figure 16](#)).



The Web embedded screens let you control the **VP-4x4K** via the Ethernet. The menu appears on the left side of the screen. There are three remote operation Web pages:

- The switching matrix (see [Section 8.2](#))
- Audio gain control (see [Section 8.3](#))
- Configuration (see [Section 8.4](#))



A help box is available for each screen when clicking the question mark that appears on the left side of the screen.

## 8.2 The VP-4x4K Switching Matrix Page

The **VP-4x4K** switching matrix page lets you route any or all of the four inputs to any or all of the eight outputs, by clicking the audio and/or video signal indicators (purple and blue, respectively):

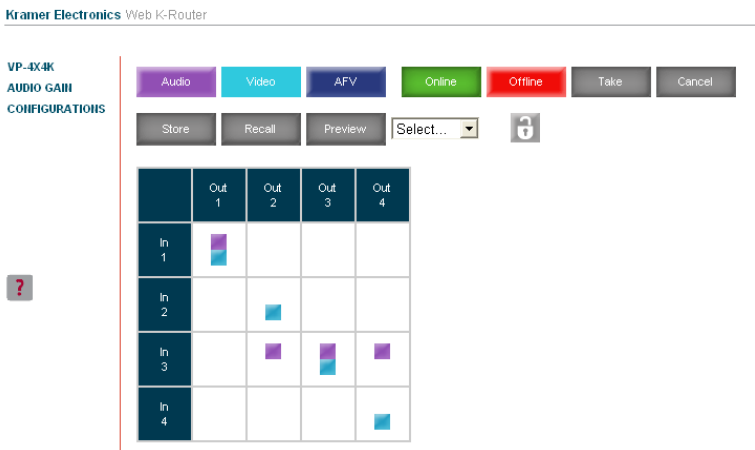

Figure 16: VP-4x4K Embedded Web Page

You can perform the following operations via this Web page:

- Operate in the AFV mode or switch the audio and video separately, by clicking the Audio, Video or AFV buttons (see [Section 8.2.1](#))
- Deselect an audio and/or video signal (depending on the operation mode – Audio, Video or AFV) by clicking that signal indicator

- Operate in the At Once or Confirm mode (see [Section 8.2.2](#))
- Lock or unlock the front panel, by clicking the lock icon
- Store and recall switching configurations (see [Section 8.2.3](#))

### 8.2.1 Switch an Input to an Output via the Embedded Web Pages

To switch an input to an output (for example, input 1 to output 4):

1. Set the button to the desired operation mode (Audio, Video or AFV, as required).
2. Click the switching-point within the switching matrix (In 2 to Out 3).  
The audio/video signal indicators move to the In 1 to Out 4 switching matrix box, indicating that In 1 is now switched to Out 4.



Figure 17: Switching an Input to an Output

### 8.2.2 Operate in the Confirm Mode

By default, the device is set to the At-Once mode. To operate in the Confirm mode:

1. Click the red Offline button.
2. Click the desired switching-point in the switching matrix.  
Audio/video indicator outlines appear and the Take and Cancel buttons turn blue.

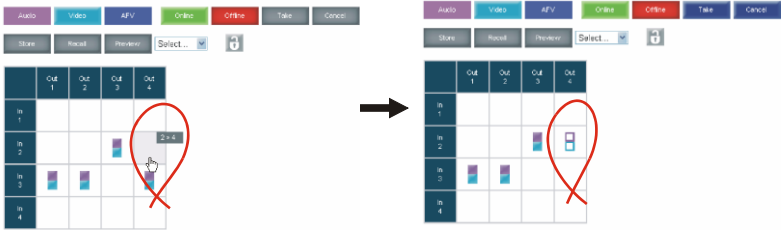

Figure 18: Switching an Input to an Output

3. Click either Take (to accept change) or Cancel.



You can repeat steps 2 and 3 several times. To confirm several actions, select several switching points and then press TAKE.

4. Click the Online button to exit the Confirm mode.

If you click the Online button before you click the TAKE button, the following warning appears:

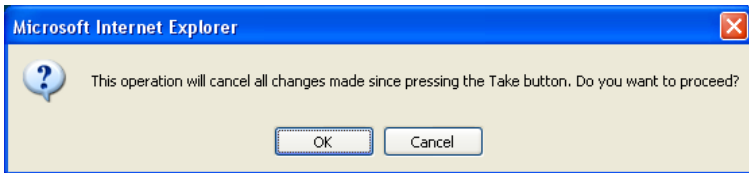

Figure 19: Exiting Offline Warning

### 8.2.3 Store and Recall Setups

To store a matrix configuration:

1. From the Preset drop-down list, select a preset (for example, Preset 07). Presets that contain a configuration are displayed with a blue background; presets with no configuration have a white background. When selecting a preset, the Store button changes from gray to dark blue.

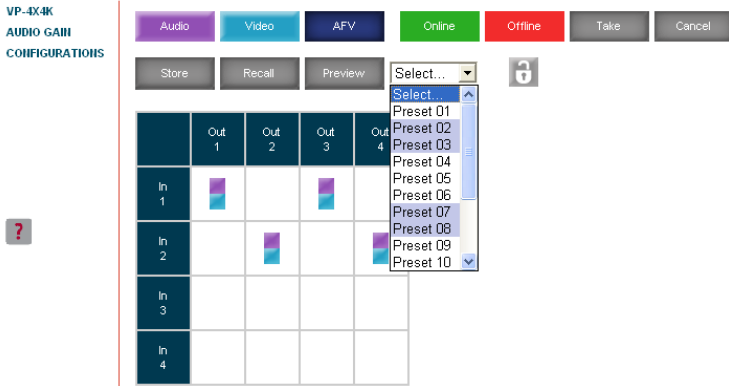

Figure 20: Selecting a preset

2. Click the Preview button to view the current setup stored in Preset 7.
3. Make sure the matrix is set to the desired configuration. If not, set it as required.
4. Click Store.

The following window appears:

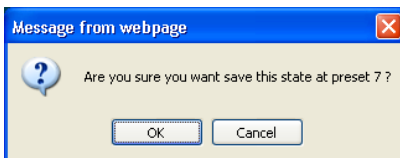

Figure 21: Save Preset Message

5. Click OK.  
The new In/Out configuration is stored in Preset 07.

To recall a preset configuration:

1. Select the desired preset number from the Preset drop-down list (for example, Preset 03):  
When selecting a preset that contains a configuration, the Recall button changes from gray to dark blue.

2. Click and hold the Preview button to view the selected Preset and then release.

3. Click Recall.

The following window appears:

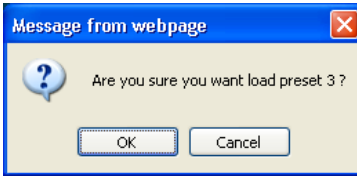

Figure 22: Load Preset Message

4. Click OK.

The new In/Out configuration takes effect.

You can recall a preset configuration in the Confirm mode by repeating the above procedure in the Offline state. The recalled configuration will become active when you press the Take button.



Figure 23: Recalling a Preset in the Confirm Mode



The Help Box

This is the main panel window. In this window you can control the channels.

## 8.3 Audio Gain Page

The Audio gain screen lets you set the gain for each of the input and output channels:

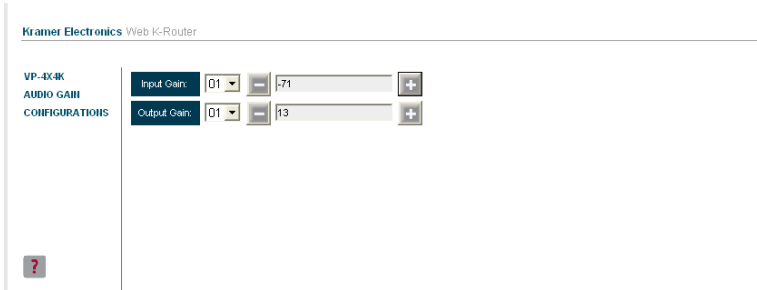

Figure 24: Audio Gain Page

To change an input or output gain, select the channel number, then click and hold the + or – buttons to increase or decrease the gain, respectively.

A single click will increase/decrease the audio gain by 0.5 units; double click to increase/decrease the gain by 1 unit.



The Help Box

In this page you can control the audio gain of the channels.

## 8.4 The CONFIGURATIONS Page

The CONFIGURATIONS page lets you view some Ethernet settings and change others (see [Figure 25](#)).

The model name, serial number, firmware version and MAC address.

To change the configuration definitions:

1. Click CONFIGURATIONS.

The CONFIGURATIONS Web page appears.

2. Change the definitions as required.
3. Click the Submit button to apply changes (or Cancel to cancel changes).  
A window appears asking if you are sure you want to change the network settings.
4. Click Yes.  
A window appears announcing that the configuration has been successfully changed.
5. Click OK
6. If the IP number had been changed, close the browser and reload the Web page.

**Kramer Electronics** Web K-Router

---

**VP-4x4K**  
**AUDIO GAIN**  
**CONFIGURATIONS**

Name:

Model:

Serial Number:

Firmware version:

MAC Address:

IP Address:

DHCP:

Gateway:

Subnet Mask:

Figure 25: CONFIGURATIONS Embedded Web Page



The Help Box 

This page lets you view and set the device configuration.

## 9 Communication Parameters

VP-4x4K communication parameters are listed here.

EDID			
EDID data is passed between Input 1 and Output 1			
RS-232			
Protocol 2000		Protocol 3000 (Default)	
Baud Rate:	9600	Baud Rate:	115,200
Data Bits:	8	Data Bits:	8
Stop Bits:	1	Stop Bits:	1
Parity:	None	Parity:	None
Command Format:	HEX	Command Format:	ASCII
Example (Output 1 to Input 1):	0x01, 0x81, 0x81, 0x81	Example (Output 1 to Input 1):	#AV 1>1<CR>
Switching Protocol			
P2000 -> P3000		P3000 -> P2000	
Command:	0x38, 0x80, 0x83, 0x81	Command:	#P2000<CR>
Front Panel:	Press and hold Output 1 and Output 3 simultaneously	Front Panel:	Press and hold Output 1 and Output 2 simultaneously
Ethernet			
Default Settings	Reset Settings		
IP Address: 192.168.1.39	Power cycle the unit while holding in the Factory Reset button, located on the rear panel of the unit.		
TCP Port #: 5000			
UDP Port #: 50000			



## 10 Technical Specifications

INPUTS:	4 UXGA on 15-pin HD connectors 4 unbalanced audio stereo signals on 3.5mm mini plug connectors	
OUTPUTS:	4 UXGA on 15-pin HD connectors 4 balanced audio stereo signals on 5-pin terminal block connectors	
MAX. OUTPUT LEVEL:	Video: 2.2Vpp	Audio: >15Vpp
BANDWIDTH (-3dB):	Video: 400MHz	Audio: 19kHz
DIFF. GAIN:	0.07%	
DIFF. PHASE:	0.03 Deg.	
K-FACTOR:	<0.05%	
S/N RATIO:	Video: 73.5dB @5MHz	Audio: 76dB unweighted
CROSSTALK (all hostile):	Video: -48dB @5MHz	Audio: -54dB @1MHz
CONTROLS:	Input-output selector, AFV, VID, AUD, STO, LOCK, RCL, TAKE, DELAY, MACH. #, RS-485, RS-232, REMOTE IR	
COUPLING:	Video: DC	Audio: AC
AUDIO THD + NOISE:	0.065% @1kHz	
AUDIO 2nd HARMONIC:	0.002% @1kHz	
POWER SOURCE:	100-240V AC, 18VA max.	
OPERATING TEMPERATURE:	0° to +40°C (32° to 104°F)	
STORAGE TEMPERATURE:	-40° to +70°C (-40° to 158°F)	
HUMIDITY:	10% to 90%, RHL non-condensing	
DIMENSIONS:	19" x 7" x 1U (W, D, H) rack mountable	
WEIGHT:	2.7kg (6 lbs) approx	
ACCESSORIES:	Power cord, rack "ears", Windows®-based control software	
Specifications are subject to change without notice at <a href="http://www.kramerelectronics.com">http://www.kramerelectronics.com</a>		

# 11 Table of ASCII Codes for Serial Communication (Protocol 3000)

The next two tables list the ASCII codes that switch an input to an output for a single VP-4x4K machine. For detailed information, see [Section 13.2](#).

VP-4x4K Video Signal Codes				
	OUT 1	OUT 2	OUT 3	OUT 4
IN 1	#V 1>1 <span>CR</span>	#V 1>2 <span>CR</span>	#V 1>3 <span>CR</span>	#V 1>4 <span>CR</span>
IN 2	#V 2>1 <span>CR</span>	#V 2>2 <span>CR</span>	#V 2>3 <span>CR</span>	#V 2>4 <span>CR</span>
IN 3	#V 3>1 <span>CR</span>	#V 3>2 <span>CR</span>	#V 3>3 <span>CR</span>	#V 3>4 <span>CR</span>
IN 4	#V 4>1 <span>CR</span>	#V 4>2 <span>CR</span>	#V 4>3 <span>CR</span>	#V 4>4 <span>CR</span>

VP-4x4K Audio Signal Codes				
	OUT 1	OUT 2	OUT 3	OUT 4
IN 1	#A 1>1 <span>CR</span>	#A 1>2 <span>CR</span>	#A 1>3 <span>CR</span>	#A 1>4 <span>CR</span>
IN 2	#A 2>1 <span>CR</span>	#A 2>2 <span>CR</span>	#A 2>3 <span>CR</span>	#A 2>4 <span>CR</span>
IN 3	#A 3>1 <span>CR</span>	#A 3>2 <span>CR</span>	#A 3>3 <span>CR</span>	#A 3>4 <span>CR</span>
IN 4	#A 4>1 <span>CR</span>	#A 4>2 <span>CR</span>	#A 4>3 <span>CR</span>	#A 4>4 <span>CR</span>

The following table lists the codes that set the audio input gain.

For detailed information, see [Section 13.2](#).

VP-4x4K Audio Input Gain Codes				
INPUT 1	INPUT 2		INPUT X*	Level [Rel]
#AUD-LVL 1,1, -100 <span>CR</span>	#AUD-LVL 1,2, -100 <span>CR</span>	...	#AUD-LVL 1,X, -100 <span>CR</span>	-100dB Mute
⋮	⋮		⋮	
#AUD-LVL 1,1, -50 <span>CR</span>	#AUD-LVL 1,2, -50 <span>CR</span>	...	#AUD-LVL 1,X, -50 <span>CR</span>	-50dB
⋮	⋮		⋮	
#AUD-LVL 1,1, 0 <span>CR</span>	#AUD-LVL 1,2, 0 <span>CR</span>	...	#AUD-LVL 1,X, 0 <span>CR</span>	0dB
⋮	⋮		⋮	
#AUD-LVL 1,1, 20 <span>CR</span>	#AUD-LVL 1,2, 20 <span>CR</span>	...	#AUD-LVL 1,X, 20 <span>CR</span>	+20dB (Max)

\* Where X is the input number from 1 - 8. For example, for channel 3 and relative level -50dB, #AUD-LVL 1,3, -50 CR

The following table lists the codes that set the audio output gain.

For detailed information, see [Section 13.2](#).

VP-4x4K Audio Output Gain Codes				
OUTPUT 1	OUTPUT 2		OUTPUT X*	Level [Rel]
#AUD-LVL 2,1, -100 <sup>CR</sup>	#AUD-LVL 2,2, -100 <sup>CR</sup>	...	#AUD-LVL 2,X, -100 <sup>CR</sup>	-100dB Mute
⋮	⋮		⋮	
#AUD-LVL 2,1, -50 <sup>CR</sup>	#AUD-LVL 2,2, -50 <sup>CR</sup>	...	#AUD-LVL 2,X, -50 <sup>CR</sup>	-50dB
⋮	⋮		⋮	
#AUD-LVL 2,1, 0 <sup>CR</sup>	#AUD-LVL 2,2, 0 <sup>CR</sup>	...	#AUD-LVL 2,X, 0 <sup>CR</sup>	0dB
⋮	⋮		⋮	
#AUD-LVL 2,1, 13 <sup>CR</sup>	#AUD-LVL 2,2, 13 <sup>CR</sup>	...	#AUD-LVL 2,X, 13 <sup>CR</sup>	+13dB (Max)

\* Where X is the output number from 1 - 8. For example, for channel 3 and relative level -50dB, **#AUD-LVL 2,3, -50<sup>CR</sup>**

---

## 12 Hex Codes for Serial Communication (Protocol 2000)

The hex codes listed in this section are used to set video channels for a single machine (set as Machine 1) connected via either RS-232 or Ethernet. Similar hex codes are used when the **VP 4x4K** is connected via RS-485 and the machine is set to number 2.

The next table lists the Hex codes that switch video channels.

Switch Video Channels				
	OUT 1	OUT 2	OUT 3	OUT 4
IN 1	01 81 81 81	01 81 82 81	01 81 83 81	01 81 84 81
IN 2	01 82 81 81	01 82 82 81	01 82 83 81	01 82 84 81
IN 3	01 83 81 81	01 83 82 81	01 83 83 81	01 83 84 81
IN 4	01 84 81 81	01 84 82 81	01 84 83 81	01 84 81 84

The next table lists the Hex codes that switch audio channels.

Switch Audio Channels				
	OUT 1	OUT 2	OUT 3	OUT 4
IN 1	02 81 81 81	02 82 81 81	02 81 83 81	02 81 81 84
IN 2	02 82 81 81	02 82 82 81	02 82 83 81	02 82 84 81
IN 3	02 83 81 81	02 83 81 82	02 83 83 81	02 83 81 84
IN 4	02 81 84 81	02 82 84 81	02 84 81 83	02 84 84 81

The next table lists the Hex codes that increase or decrease audio input gain.

Increase/Decrease Audio Input Gain				
	IN 1	IN 2	IN 3	IN 4
Increase	18 81 86 81	18 82 86 81	18 83 86 81	18 84 86 81
Decrease	18 81 87 81	18 82 87 81	18 83 87 81	18 84 87 81

The next table lists the Hex codes that set the audio input gain. Before sending the any of these codes, the command 2A 86 80 81 must be sent.

Set the Audio Input Gain				
IN 1	IN 2	IN 3	IN 4	Level [Rel]
16 81 80 81	16 82 80 81	16 83 80 81	16 84 80 81	Mute
⋮	⋮	⋮	⋮	
16 81 87* 81	16 82 87* 81	16 83 87* 81	16 84 87* 81	-100dB Mute
⋮	⋮	⋮	⋮	
16 81 B9 81	16 82 B9 81	16 83 B9 81	16 84 B9 81	-50dB
⋮	⋮	⋮	⋮	
16 81 EB 81	16 82 EB 81	16 83 EB 81	16 84 EB 81	0dB
⋮	⋮	⋮	⋮	
16 81 FF 81	16 82 FF 81	16 83 FF 81	16 84 FF 81	+20dB (Max)

\* BYTE 3 = 0x80 + Gain Value (0x00-0x7F)

The next table lists the Hex codes that increase or decrease the audio output gain.

	Increase/Decrease the Audio Output Gain			
	OUT 1	OUT 2	OUT 3	OUT 4
Increase	18 81 80 81	18 82 80 81	18 83 80 81	18 84 80 81
Decrease	18 81 81 81	18 82 81 81	18 83 81 81	18 84 81 81

The next table lists the Hex codes that set the audio output gain. Before sending the any of these codes, the command 2A 87 80 81 must be sent.

Set the Audio Output Gain				
OUT 1	OUT 2	OUT 3	OUT 4	Level [Rel]
16 81 80 81	16 82 80 81	16 83 80 81	16 84 80 81	Mute
⋮	⋮	⋮	⋮	
16 81 8E* 81	16 82 8E* 81	16 83 8E* 81	16 84 8E* 81	-100dB Mute
⋮	⋮	⋮	⋮	
16 81 C0 81	16 82 C0 81	16 83 C0 81	16 84 C0 81	-50dB
⋮	⋮	⋮	⋮	
16 81 F2 81	16 82 F2 81	16 83 F2 81	16 84 F2 81	0dB
⋮	⋮	⋮	⋮	
16 81 FF 81	16 82 FF 81	16 83 FF 81	16 84 FF 81	+13dB (Max)

\*BYTE 3 = 0x80 + Gain Value (0x00-0x7F)

---

# 13 Kramer Protocol

[Section 13.1](#) describes how to switch between Protocol 3000 and Protocol 2000.

[Section 13.2](#) defines Protocol 3000. [Section 13.3](#) defines Protocol 2000.

You can download our user friendly “Software for Calculating Hex Codes for Protocol 2000” from the technical support section on our Web site at: <http://www.kramerelectronics.com>.

By default, the **VP-4x4K** is set to Kramer’s Protocol 3000, but it is also compatible with Protocol 2000.

## 13.1 Switching Protocols

You can switch protocols either via the front panel buttons (see [Section 13.1.1](#)) or by sending protocol commands (see [Section 13.1.2](#)).

### 13.1.1 Switching Protocols via the Front Panel Buttons

To switch from Protocol 3000 to Protocol 2000, press and hold the OUT 1 and OUT 2 buttons for a few seconds.

The display shows 2000.

To switch from Protocol 2000 to Protocol 3000, press and hold the OUT 1 and OUT 3 buttons for a few seconds.

The display shows 3000.

### 13.1.2 Switching Protocols via Protocol Commands

To switch from Protocol 3000 to Protocol 2000, send the following command:

- #P2000<CR>

To switch from Protocol 2000 to Protocol 3000, send the following command:

- 0x38, 0x80, 0x83, 0x81

The Windows®-based Kramer control software (not as part of a switching operation) operates with Protocol 2000. If the **VP-4x4K** is set to Protocol 3000, it is automatically switched to Protocol 2000.

## 13.2 Kramer Protocol 3000

This RS-232/RS-485 communication protocol lets you control the machine from any standard terminal software (for example, Windows® HyperTerminal Application). Communication parameters are: data rate 115200 baud, no parity, 8 data bits, and 1 stop bit.

### 13.2.1 Protocol 3000 Syntax

Host message format:

Start	Address (optional)	Body	Delimiter
#	Destination_id@	message	CR

Simple command (commands string with only one command without addressing):

Start	Body	Delimiter
#	Command SP Parameter_1,Parameter_2,...	CR

Command string (formal syntax with commands concatenation and addressing):

# Address@ Command\_1 Parameter1\_1,Parameter1\_2,... |Command\_2  
Parameter2\_1,Parameter2\_2,... |Command\_3 Parameter3\_1,Parameter3\_2,...  
|...CR

Device message format:

Start	Address (optional)	Body	Delimiter
~	Sender_id@	message	CR LF

Device long response (Echoing command):

Start	Address (optional)	Body	Delimiter
~	Sender_id@	command SP [param1 ,param2 ...] result	CR LF

CR = Carriage return (ASCII 13 = 0x0D)

LF = Line feed (ASCII 10 = 0x0A)

SP = Space (ASCII 32 = 0x20)

## 13.2.2 Command Terms

### Command

A sequence of ASCII letters ('A'-'Z', 'a'-'z' and '-').

Command and parameters must be separated by at least one space.

### Parameters

A sequence of alphanumeric ASCII characters ('0'-'9','A'-'Z','a'-'z' and some special characters for specific commands). Parameters are separated by commas.

### Message string

Every command entered as part of a message string begins with a **message starting character** and ends with a **message closing character**.

**Note:** A string can contain more than one command. Commands are separated by a pipe ( '|') character.

### Message starting character

'#' – For host command/query

'~' – For machine response

**Device address** (Optional when directly connected to the device)

K-NET Device ID or MACHINE NUMBER followed by '@'

(ex. #02@CRLF)

### Query sign

'?' follows some commands to define a query request.

### All outputs sign

'\*' defines all outputs.

### Message closing character

CR – For host messages; carriage return (ASCII 13)

CRLF – For machine messages; carriage return (ASCII 13) + line-feed (ASCII 10)

### Command chain separator character

When a message string contains more than one command, a pipe ( '|') character separates each command.

Spaces between parameters or command terms are ignored.



### 13.2.3 Entering Commands

You can directly enter all commands using a terminal with ASCII communications software, such as HyperTerminal, Hercules, etc. Connect the terminal to the serial, Ethernet, or USB port on the Kramer device. To enter `CR`, press the Enter key. (`LF` is also sent but is ignored by command parser).

For commands sent from some non-Kramer controllers like Crestron, some characters require special coding (such as, `/X##`). Refer to the controller manual.

### 13.2.4 Command Forms

Some commands have short name syntax in addition to long name syntax to allow faster typing. The response is always in long syntax.

### 13.2.5 Command Chaining

Multiple commands can be chained in the same string. Each command is delimited by a pipe character ( `|` ). When chaining commands, enter the message starting character and the message closing character only once, at the beginning of the string and at the end.

Commands in the string do not execute until the closing character is entered. A separate response is sent for every command in the chain.

### 13.2.6 Maximum String Length

64 characters.

### 13.2.7 Backward Support

Protocol 2000 is transparently supported by Protocol 3000. You can switch between protocols using a switch protocol command from either platform.

## 13.2.8 Instruction Codes

Instruction Codes for Protocol 3000		
Help Commands		
Command	Syntax	Response
Protocol Handshaking	#CR	~OKCRLF
Device Initiated Messages		
Command	Syntax	
Start message	Kramer Electronics LTD. , <u>Device Model</u> Version <u>Software Version</u>	
Switcher Actions		
Audio-video channel has switched (AFV mode)	AV <u>IN&gt;OUT</u>	
Video channel has switched (Breakaway mode)	VID <u>IN&gt;OUT</u>	
Audio channel has switched (Breakaway mode)	AUD <u>IN&gt;OUT</u>	
Result Codes (Errors)		
		Syntax
No error. Command running succeeded		<u>COMMAND</u> <u>PARAMETERS</u> OK
Protocol Errors		
Syntax Error		ERR001
Command not available for this device		ERR002
Parameter is out of range		ERR003
Unauthorized access (running command without the match login).		ERR004
Basic Routing Commands		
Command	Syntax	Response
Switch audio & video	AV <u>IN&gt;OUT</u> , <u>IN&gt;OUT</u> , ...	AV <u>IN&gt;OUT</u> , <u>IN&gt;OUT</u> ,... <u>RESULT</u>
Switch video only	VID <u>IN&gt;OUT</u> , <u>IN&gt;OUT</u> , ... Short form: V <u>IN&gt;OUT</u> , <u>IN&gt;OUT</u> , ...	VID <u>IN&gt;OUT</u> , <u>IN&gt;OUT</u> , ... <u>RESULT</u>
Note: When AFV mode is active, this command will switch also audio. If audio is breakaway – device display mode will change to show audio connections status.		
Switch audio only	AUD <u>IN&gt;OUT</u> , <u>IN&gt;OUT</u> , ... Short form: A <u>IN&gt;OUT</u> , <u>IN&gt;OUT</u> , ...	AUD <u>IN&gt;OUT</u> , <u>IN&gt;OUT</u> , ... <u>RESULT</u>
Note: When AFV mode is active, this command will switch also video.		
Read video connection	VID? <u>OUT</u> Short form: V? <u>OUT</u> VID? *	VID <u>IN&gt;OUT</u>  VID <u>IN&gt;1</u> , <u>IN&gt;2</u> , ...

Basic Routing Commands		
Command	Syntax	Response
Read audio connection	AUD? <u>OUT</u> Short form: A? <u>OUT</u> AUD? *	AUD <u>IN</u> - <u>OUT</u>  AUD <u>IN</u> >1, <u>IN</u> >2, ...
Parameter Description: <u>IN</u> = Input number or '0' to disconnect output. '>' = Connection character between in and out parameters. <u>OUT</u> = Output number or '*' for all outputs.		
Examples:		
Switch Video and Audio input 3 to output 7	#AV 3>7 <u>CR</u>	~AV 3>7 OK <u>CRLF</u>
Switch Video input 2 to output 4	#V 2>4 <u>CR</u>	~VID 2>4 OK <u>CRLF</u>
Switch Video input 4 to output 2 in machine number 6	#6@VID 4>2 <u>CR</u>	~6@VID 4>2 OK <u>CRLF</u>
Disconnect Video and Audio Output 4	#AV 0>4 <u>CR</u>	~AV 0>4 OK <u>CRLF</u>
Switch Video Input 3 to All Outputs	#V 3>* <u>CR</u>	~VID 3>* OK <u>CRLF</u>
Chaining Multiple commands*	#AV 1>*   V 3>4, 2>2, 82>1, 0>2   V 82>3   A 0>1   V? * <u>CR</u> First switch all Audio and video outputs from input 1, Then switch video input 3 to output 4, video input 2 to output 2, video input and disconnect video output 2. Then switch audio input 3 to output 2, Then disconnect audio output 1. Then get status of all links (assume this is 4x4 matrix). Commands processing start after entering <u>CR</u> , response will sent for each command after processing it.	~AV 1>* OK <u>CRLF</u> ~VID 1>2, 3>4 OK <u>CRLF</u> ~VID 82>3 <u>ERR###</u> <u>CRLF</u> ~AUD 0>1 OK <u>CRLF</u> ~V 1>1, 0>2, 1>3, 3>4 <u>CRLF</u>

Signal Status Commands		
Command	Syntax	Response
Change signal status	-----	SIGNAL <u>INPUT</u> , <u>STATUS</u>
Get signal status	SIGNAL? <u>INPUT</u>	SIGNAL <u>INPUT</u> , <u>STATUS</u>

Parameters Description: <u>INPUT</u> = Input number, '*' for all. <u>STATUS</u> = Signal state: "0" or "off" for not existent signal. "1" or "on" for existent signal.
--

Preset Commands		
Command	Syntax	Response
Store current connections to preset	PRST-STO <u>PRESET</u> Short form: PSTO <u>PRESET</u>	PRST-STO <u>PRESET</u> <u>RESULT</u>

Preset Commands		
Command	Syntax	Response
Recall saved preset	PRST-RCL <u>PRESET</u> Short form: PRCL <u>PRESET</u>	PRST-RCL <u>PRESET</u> <u>RESULT</u>
Delete saved preset	PRST-DEL <u>PRESET</u> Short form: PDEL <u>PRESET</u>	PRST-DEL <u>PRESET</u> <u>RESULT</u>
Read video connections from saved preset	PRST-VID? <u>PRESET</u> , <u>OUT</u> Short form: PVID? <u>PRESET</u> , <u>OUT</u> PRST-VID? <u>PRESET</u> , *	PRST-VID <u>PRESET</u> , <u>IN</u> , <u>OUT</u> PRST-VID <u>PRESET</u> , <u>IN</u> >1, <u>IN</u> >2,...
Read audio connections from saved preset	PRST-AUD? <u>PRESET</u> , <u>OUT</u> Short form: PAUD? <u>PRESET</u> , <u>OUT</u> PRST-AUD? <u>PRESET</u> , *	PRST-AUD <u>PRESET</u> : <u>IN</u> , <u>OUT</u> PRST-AUD <u>PRESET</u> : <u>IN</u> >1, <u>IN</u> >2,...
Read saved presets list	PRST-LST? Short form: PLST?	PRST-LST <u>PRESET</u> , <u>PRESET</u> , ...
Parameters Description: <u>PRESET</u> = Preset number. <u>OUT</u> = Output in preset to show for, '*' for all.		

Examples		
Store current Audio & Video connections to preset 5	#PRST-STR 5 <u>CR</u>	~PRST-STR 5 OK <u>CRLF</u>
Recall Audio & Video connections from preset 3	#PRCL 3 <u>CR</u>	~PRST-RCL 3 OK <u>CRLF</u>
Show source of video output 2 from preset 3	#PRST-VID? 3,2 <u>CR</u>	~PRST-VID 3: 4>2 <u>CRLF</u>

Operation Commands		
Command	Syntax	Response
Lock front panel	LOCK-FP <u>LOCK-MODE</u> Short form: LCK <u>LOCK-MODE</u>	LOCK-FP <u>LOCK-MODE</u> <u>RESULT</u>
Get front panel locking state	LOCK-FP?	LOCK-FP <u>LOCK-MODE</u>
Parameters Description: <u>LOCK-MODE</u> = Front panel locking state: "0" or "off" to unlock front panel buttons. "1" or "on" to lock front panel buttons.		
Restart device	RESET	RESET OK
Switch to Protocol 2000*	P2000	P2000 OK
* Protocol 2000 has command to switch back to ASCII protocol (like Protocol 3000)		

Audio Parameter Commands		
Command	Syntax	Response
Set audio level in specific amplifier stage	AUD-LVL <u>STAGE</u> <u>CHANNEL</u> , <u>VOLUME</u> Short form: ADL <u>STAGE</u> , <u>CHANNEL</u> , <u>VOLUME</u>	AUD-LVL <u>STAGE</u> , <u>CHANNEL</u> , <u>VOLUME</u> <u>RESULT</u>
Read audio volume level	AUD-LVL? <u>STAGE</u> , <u>CHANNEL</u> Short form: ADL? <u>STAGE</u>	AUD-LVL <u>STAGE</u> , <u>CHANNEL</u> , <u>VOLUME</u>
Mute audio output	MUTE <u>CHANNEL</u>   <u>MUTE-</u> <u>MODE</u>	MUTE <u>CHANNEL</u>   <u>MUTE-MODE</u>

Parameter Description:

STAGE =

"In", "Out"

or

Numeric value (present audio processing stage). For example: "0" for Input level, "1" for Pre-Amplifier, "2" for Amplifier (Out) etc.

CHANNEL = Input or Output #

VOLUME = Audio parameter in Kramer units, precede minus sign for negative values.

++ increase current value,

-- decrease current value.

### Machine Info Commands

Command	Syntax	Response
* Time settings commands require admin authorization		
Read in/outs count	INFO-IO?	INFO-IO: IN <u>INPUTS_COUNT</u> , OUT <u>OUTPUTS_COUNT</u>
Read max presets count	INFO-PRST?	INFO-PRST: VID <u>PRESET_VIDEO_COUNT</u> , AUD <u>PRESET_AUDIO_COUNT</u>
Reset configuration to factory default	FACTORY	FACTORY <u>RESULT</u>

### Identification Commands

Command	Syntax	Response
Protocol Handshaking	# <u>CR</u>	~OK <u>CRLF</u>
Read device model	MODEL?	MODEL <u>MACHINE_MODEL</u>
Read device serial number	SN?	SN <u>SERIAL_NUMBER</u>
Read device firmware version	VERSION?	VERSION <u>MAJOR</u> , <u>MINOR</u> , <u>BUILD</u> , <u>REVISION</u>

Identification Commands		
Command	Syntax	Response
Set machine name	NAME <u>MACHINE_NAME</u>	NAME <u>MACHINE_NAME</u> <u>RESULT</u>
Read machine name	NAME?	NAME <u>MACHINE_NAME</u>
Reset machine name to factory default*	NAME-RST	NAME-RST <u>MACHINE_FACTORY_NAME</u> <u>RESULT</u>
<p>*Note: machine name not equal to model name. This name relevance for site viewer identification of specific machine or for network using (with DNS feature on).  <u>MACHINE_NAME</u> = Up to 14 Alfa-Numeric chars.            * Machine factory name = Model name + last 4 digits from serial number.</p>		
Set machine id number	MACH-NUM <u>MACHINE_NUMBER</u>	MACH-NUM <u>OLD_MACHINE_NUMBER</u> <u>NEW_MACHINE_NUMBER</u> <u>RESULT</u>
<p>* Response will send after machine number has been changed. So the replay with header will be:  <u>NEW_MACHINE_NUMBER</u> @MACH-NUM <u>OLD_MACHINE_NUMBER</u> <u>NEW_MACHINE_NUMBER</u>            OK</p>		

Network Setting Commands		
Set IP Address	NET-IP <u>IP_ADDRESS</u> NTIP	NET-IP <u>IP_ADDRESS</u> <u>RESULT</u>
Read IP Address	NET-IP? NTIP?	NET-IP <u>IP_ADDRESS</u>
Read MAC Address	NET-MAC? NTMC	NET-MAC <u>MAC_ADDRESS</u>
Set subnet mask	NET-MASK <u>SUBNET_MASK</u> NTMSK	NET-MASK <u>SUBNET_MASK</u> <u>RESULT</u>
Read subnet mask	NET-MASK? NTMSK?	NET-MASK <u>SUBNET_MASK</u>
Set gateway address	NET-GATE <u>GATEWAY_ADDRESS</u> NTGT	NET-GATE <u>GATEWAY_ADDRESS</u> <u>RESULT</u>
Read subnet mask	NET-GATE? NTGT?	NET-GATE <u>GATEWAY_ADDRESS</u>
Set DHCP mode	NET-DHCP <u>DHCP_MODE</u> NTDH	NET-DHCP <u>DHCP_MODE</u> <u>RESULT</u>
Read subnet mask	NET-DHCP? NTDH?	NET-DHCP <u>DHCP_MODE</u>
<p><u>DHCP_MODE</u> =            0 – Don't use DHCP (Use IP set by factory or IP set command).            1 – Try to use DHCP, if unavailable use IP as above.</p>		
Change protocol ethernet port	ETH-PORT <u>PROTOCOL</u> , <u>PORT</u> ETHP	ETH-PORT <u>PROTOCOL</u> , <u>PORT</u> <u>RESULT</u>
Read protocol	ETH-PORT? <u>PROTOCOL</u>	ETH-PORT <u>PROTOCOL</u> , <u>PORT</u>

### Network Setting Commands

ethernet port	ETHP?	
---------------	-------	--

**PROTOCOL** = TCP/UDP (transport layer protocol)

**PORT** = ethernet port to enter Protocol 3000 commands.

1-65535 = User defined port

0 - reset port to factory default (50000 for UDP, 5000 for TCP)

### Advanced Switching Commands

Command	Syntax	Response
---------	--------	----------

Set audio follow video mode	AFV <b>AFV-MODE</b>	AFV <b>AFV-MODE</b> <b>RESULT</b>
-----------------------------	---------------------	-----------------------------------

Note:

This command effect device front-panel mode and AUD\VID command.

Read audio follow video mode	AFV?	AFV <b>AFV-MODE</b>
------------------------------	------	---------------------

**AFV-MODE** = Front panel AFV mode

"0" to set front panel switching buttons in audio-follow-video state.

"1" to set front panel switching buttons in their previous state audio breakaway.

## 13.3 Kramer Protocol 2000

This RS-232/RS-485 communication protocol uses four bytes of information as defined below. The default data rate is 9600 baud, with no parity, 8 data bits, and 1 stop bit.

Table 1: Protocol Definitions

MSB								LSB
1 <sup>st</sup> Byte	<b>DESTINATION</b>	<b>INSTRUCTION</b>						
0	D	N5	N4	N3	N2	N1	N0	
7	6	5	4	3	2	1	0	
2d Byte	<b>INPUT</b>							
1	I6	I5	I4	I3	I2	I1	I0	
7	6	5	4	3	2	1	0	
3d Byte	<b>OUTPUT</b>							
1	O6	O5	O4	O3	O2	O1	O0	
7	6	5	4	3	2	1	0	
4 <sup>th</sup> Byte	<b>MACHINE NUMBER</b>							
1	OVR	X	M4	M3	M2	M1	M0	
7	6	5	4	3	2	1	0	

1<sup>st</sup> BYTE: Bit 7 – Defined as 0.

D – "DESTINATION": 0 - for sending information to the switchers (from the PC);

1 - for sending to the PC (from the switcher).

N5...N0 – "INSTRUCTION"

The function that is to be performed by the switcher(s) is defined by the INSTRUCTION (6 bits). Similarly, if a function is performed via the machine's keyboard, then these bits are set with the INSTRUCTION NO., which was performed. The instruction codes are defined according to the table below (INSTRUCTION NO. is the value to be set for N5...N0).

2<sup>nd</sup> BYTE: Bit 7 – Defined as 1.

I6...I0 – "INPUT".

When switching (i.e. instruction codes 1 and 2), the INPUT (7 bits) is set as the input number which is to be switched.

Similarly, if switching is done via the machine's front-panel, then these bits are set with the INPUT NUMBER which was switched. For other operations, these bits are defined according to the table.

3<sup>rd</sup> BYTE: Bit 7 – Defined as 1.

O6...O0 – "OUTPUT".

When switching (i.e. instruction codes 1 and 2), the OUTPUT (7 bits) is set as the output number which is to be switched. Similarly, if switching is done via the machine's front-panel, then these bits are set with the OUTPUT

NUMBER which was switched. For other operations, these bits are defined according to the table.

4<sup>th</sup> BYTE: Bit 7 – Defined as 1.

Bit 5 – Don't care.

OVR – Machine number override.

M4...M0 – MACHINE NUMBER.

Used to address machines in a system via their machine numbers. When several machines are controlled from a single serial port, they are usually configured together with each machine having an individual machine number. If the OVR bit is set, then all machine numbers will accept (implement) the command, and the addressed machine will reply.

For a single machine controlled via the serial port, always set M4...M0 = 1, and make sure that the machine itself is configured as MACHINE NUMBER = 1.



Note: All values in the table are decimal, unless otherwise stated.

Instruction Codes for Protocol 2000				
INSTRUCTION		DEFINITION FOR SPECIFIC INSTRUCTION		NOTE
#	DESCRIPTION	INPUT	OUTPUT	
0	RESET VIDEO	0	0	1
1	SWITCH VIDEO	Set equal to video input which is to be switched (0 = disconnect)	Set equal to video output which is to be switched (0 = to all the outputs)	2
2	SWITCH AUDIO	Set equal to audio input which is to be switched (0 = disconnect)	Set equal to audio output which is to be switched (0 = to all the outputs)	2
3	STORE VIDEO STATUS	Set as SETUP #	0 - to store 1 - to delete	2, 3
4	RECALL VIDEO STATUS	Set as SETUP #	0	2, 3
5	REQUEST STATUS OF A VIDEO OUTPUT	Set as SETUP #	Equal to output number whose status is requested	4, 3
6	REQUEST STATUS OF AN AUDIO OUTPUT	Set as SETUP #	Equal to output number whose status is requested	4, 3
8	BREAKAWAY SETTING	0	0 - audio-follow-video 1 - audio breakaway	2
11	REQUEST BREAKAWAY SETTING	Set as SETUP #	0 - Request audio breakaway setting	3, 4, 6
15	REQUEST WHETHER SETUP IS DEFINED/VALID INPUT IS DETECTED	SETUP # or Input #	0 - for checking if setup is defined 1 - for checking if input is valid	8
16	ERROR/BUSY	For invalid/valid input (i.e. OUTPUT byte = 4 or OUTPUT byte = 5), this byte is set as the input #	0 - error 1 - invalid instruction 2 - out of range 3 - machine busy 4 - invalid input 5 - valid input 6 - RX buffer overflow	9, 25
22	SET AUDIO PARAMETER	Equal to input/output number whose parameter is to be set (0 = all)	Set as parameter value	2, 24
24	INCREASE/DECREASE AUDIO PARAMETER	Equal to input/output number whose parameter is to be increased/decreased (0 = all)	0 - increase output 1 - decrease output 2 - increase left output 3 - decrease left output 4 - increase right output 5 - decrease right output 6 - increase input 7 - decrease input 8 - increase left input 9 - decrease left input 10 - increase right input 11 - decrease right input	2
25	REQUEST AUDIO PARAMETER	Equal to input/output number whose parameter is requested	0	6, 24
30	LOCK FRONT PANEL	0 - Panel unlocked 1 - Panel locked	0	2
31	REQUEST WHETHER PANEL IS LOCKED	0	0	16
42	AUDIO PARAMETER SETTINGS FOR INSTRUCTIONS 22, 25	INPUT Bit: 10 - 0=input; 1=output		24
56	CHANGE TO ASCII	0	Kramer Protocol 3000	19
61	IDENTIFY MACHINE	1 - video machine name 2 - audio machine name 3 - video software version 4 - audio software version	0 - Request first 4 digits 1 - Request first suffix 2 - Request second suffix 3 - Request third suffix 10 - Request first prefix 11 - Request second prefix 12 - Request third prefix	13

Instruction Codes for Protocol 2000				
INSTRUCTION		DEFINITION FOR SPECIFIC INSTRUCTION		NOTE
#	DESCRIPTION	INPUT	OUTPUT	
62	DEFINE MACHINE	1 - number of inputs 2 - number of outputs 3 - number of setups	1 - for video 2 - for audio	14

NOTES on the above table:

**NOTE 1** - When the master switcher is reset, (e.g. when it is turned on), the reset code is sent to the PC. If this code is sent to the switchers, it will reset according to the present power-down settings.

**NOTE 2** - These are bi-directional definitions. That is, if the switcher receives the code, it will perform the instruction; and if the instruction is performed (due to a keystroke operation on the front panel), then these codes are sent. For example, if the HEX code

01            85            88            83

was sent from the PC, then the switcher (machine 3) will switch input 5 to output 8. If the user switched input 1 to output 7 via the front panel keypad, then the switcher will send HEX codes:

41            81            87            83

to the PC.

When the PC sends one of the commands in this group to the switcher, then, if the instruction is valid, the switcher replies by sending to the PC the same four bytes that it was sent (except for the first byte, where the DESTINATION bit is set high).

**NOTE 3** - SETUP # 0 is the present setting. SETUP # 1 and higher are the settings saved in the switcher's memory, (i.e. those used for Store and Recall).

**NOTE 4** - The reply to a "REQUEST" instruction is as follows: the same instruction and INPUT codes as were sent are returned, and the OUTPUT is assigned the value of the requested parameter. The replies to instructions 10 and 11 are as per the definitions in instructions 7 and 8 respectively. For example, if the present status of machine number 5 is breakaway setting, then the reply to the HEX code

0B            80            80            85

would be HEX codes

4B            80            81            85

**NOTE 6** - If INPUT is set to 127 for these instructions, then, if the function is defined on this machine, it replies with OUTPUT=1. If the function is not defined, then the machine replies with OUTPUT=0, or with an error (invalid instruction code).

If the INPUT is set to 126 for these instructions, then, if possible, the machine will return the current setting of this function, even for the case that the function is not defined. For example, for a video switcher which always switches during the VIS of input #1, (and its VIS setting cannot be programmed otherwise), the reply to the HEX code

0A            FE            80            81 (i.e. request VIS setting, with INPUT set as 126dec)

would be HEX codes

4A            FE            81            81 (i.e. VIS setting = 1, which is defined as VIS from input #1).

**NOTE 8** - The reply is as in TYPE 3 above, except that here the OUTPUT is assigned with the value 0 if the setup is not defined/no valid input is detected; or 1 if it is defined/valid input is detected.

**NOTE 9** - An error code is returned to the PC if an invalid instruction code was sent to the switcher, or if a parameter associated with the instruction is out of range (e.g. trying to save to a setup greater than the highest one, or trying to switch an input or output greater than the highest one defined). This code is also returned to the PC if an RS-232 instruction is sent while the machine is being programmed via the front panel. Reception of this code by the switcher is not valid.

**NOTE 10** - This code is reserved for internal use.

**NOTE 13** - This is a request to identify the switcher/s in the system. If the OUTPUT is set as 0, and the INPUT is set as 1, 2, 5 or 7, the machine will send its name. The reply is the decimal value of the INPUT and OUTPUT. For example, for a 2216, the reply to the request to send the audio machine name would be (HEX codes):

7D            96            90            81 (i.e. 128dec+ 22dec for 2nd byte, and 128dec+ 16dec for 3rd byte).

If the request for identification is sent with the INPUT set as 3 or 4, the appropriate machine will send its software version number. Again, the reply would be the decimal value of the INPUT and OUTPUT - the INPUT representing the number in front of the decimal point, and the OUTPUT representing the number after it. For example, for version 3.5, the reply to the request to send the version number would be (HEX codes):

7D            83            85            81 (i.e. 128dec+ 3dec for 2nd byte, 128dec+ 5dec for 3rd byte).

If the OUTPUT is set as 1, then the ASCII coding of the lettering following the machine's name is sent. For example, for the VS-7588YC, the reply to the request to send the first suffix would be (HEX codes):

7D            D9            C3            81 (i.e. 128dec+ ASCII for "Y"; 128dec+ ASCII for "C").

**NOTE 14** - The number of inputs and outputs refers to the specific machine which is being addressed, not to the system. For example, if six 16X16 matrices are configured to make a 48X32 system (48 inputs, 32 outputs), the reply to the HEX code

3E            82            81            82 (i.e. request the number of outputs)

would be HEX codes

7E            82            90            82

i.e. 16 outputs

**NOTE 16** - The reply to the "REQUEST WHETHER PANEL IS LOCKED" is as in NOTE 4 above, except that here the OUTPUT is assigned with the value 0 if the panel is unlocked, or 1 if it is locked.

**NOTE 19** – After this instruction is sent, the unit will respond to the ASCII command set defined by the OUTPUT byte. The ASCII command to operate with the HEX command set must be sent in order to return to working with HEX codes.

**NOTE 24** – Further information needed in instructions 22 and 25, is sent using instruction 42 – which is sent prior to the instruction. For example, to request the audio gain value of output # 9, send hex codes

2A        81            80            81

and then send HEX codes

19        89            81            81.

To set input gain change mode, send hex codes

2A    80    80    81

and then send HEX code

16

**NOTE 25** – For units which detect the validity of the video inputs, Instruction 16 will be sent whenever the unit detects a change in the state of an input (in real-time).

For example, if input 3 is detected as invalid, the unit will send the HEX codes

10        83            84            81

If input 7 is detected as valid, then the unit will send HEX codes

10        87            85            81

## LIMITED WARRANTY

The warranty obligations of Kramer Electronics for this product are limited to the terms set forth below:

### What is Covered

This limited warranty covers defects in materials and workmanship in this product.

### What is Not Covered

This limited warranty does not cover any damage, deterioration or malfunction resulting from any alteration, modification, improper or unreasonable use or maintenance, misuse, abuse, accident, neglect, exposure to excess moisture, fire, improper packing and shipping (such claims must be presented to the carrier), lightning, power surges, or other acts of nature. This limited warranty does not cover any damage, deterioration or malfunction resulting from the installation or removal of this product from any installation, any unauthorized tampering with this product, any repairs attended by anyone unauthorized by Kramer Electronics to make such repairs, or any other cause which does not relate directly to a defect in materials and/or workmanship of this product. This limited warranty does not cover cartons, equipment enclosures, cables or accessories used in conjunction with this product.

Without limiting any other exclusion herein, Kramer Electronics does not warrant that the product covered hereby, including, without limitation, the technology and/or integrated circuit(s) included in the product, will not become obsolete or that such items are or will remain compatible with any other product or technology with which the product may be used.

### How Long Does this Coverage Last

Seven years as of this printing; please check our Web site for the most current and accurate warranty information.

### Who is Covered

Only the original purchaser of this product is covered under this limited warranty. This limited warranty is not transferable to subsequent purchasers or owners of this product.

### What Kramer Electronics will do

Kramer Electronics will, at its sole option, provide one of the following three remedies to whatever extent it shall deem necessary to satisfy a proper claim under this limited warranty:

1. Elect to repair or facilitate the repair of any defective parts within a reasonable period of time, free of any charge for the necessary parts and labor to complete the repair and restore this product to its proper operating condition. Kramer Electronics will also pay the shipping costs necessary to return this product once the repair is complete.
2. Replace this product with a direct replacement or with a similar product deemed by Kramer Electronics to perform substantially the same function as the original product.
3. Issue a refund of the original purchase price less depreciation to be determined based on the age of the product at the time remedy is sought under this limited warranty.

### What Kramer Electronics will not do Under This Limited Warranty

If this product is returned to Kramer Electronics or the authorized dealer from which it was purchased or any other party authorized to repair Kramer Electronics products, this product must be insured during shipment, with the insurance and shipping charges prepaid by you. If this product is returned uninsured, you assume all risks of loss or damage during shipment. Kramer Electronics will not be responsible for any costs related to the removal or re-installation of this product from or into any installation. Kramer Electronics will not be responsible for any costs related to any setting up this product, any adjustment of user controls or any programming required for a specific installation of this product.

### How to Obtain a Remedy under this Limited Warranty

To obtain a remedy under this limited warranty, you must contact either the authorized Kramer Electronics reseller from whom you purchased this product or the Kramer Electronics office nearest you. For a list of authorized Kramer Electronics resellers and/or Kramer Electronics authorized service providers, please visit our web site at [www.kramerelectronics.com](http://www.kramerelectronics.com) or contact the Kramer Electronics office nearest you.

In order to pursue any remedy under this limited warranty, you must possess an original, dated receipt as proof of purchase from an authorized Kramer Electronics reseller. If this product is returned under this limited warranty, a return authorization number, obtained from Kramer Electronics, will be required. You may also be directed to an authorized reseller or a person authorized by Kramer Electronics to repair the product.

If it is decided that this product should be returned directly to Kramer Electronics, this product should be properly packed, preferably in the original carton, for shipping. Cartons not bearing a return authorization number will be refused.

### Limitation on Liability

THE MAXIMUM LIABILITY OF KRAMER ELECTRONICS UNDER THIS LIMITED WARRANTY SHALL NOT EXCEED THE ACTUAL PURCHASE PRICE PAID FOR THE PRODUCT. TO THE MAXIMUM EXTENT PERMITTED BY LAW, KRAMER ELECTRONICS IS NOT RESPONSIBLE FOR DIRECT, SPECIAL, INCIDENTAL OR CONSEQUENTIAL DAMAGES RESULTING FROM ANY BREACH OF WARRANTY OR CONDITION, OR UNDER ANY OTHER LEGAL THEORY. Some countries, districts or states do not allow the exclusion or limitation of relief, special, incidental, consequential or indirect damages, or the limitation of liability to specified amounts, so the above limitations or exclusions may not apply to you.

### Exclusive Remedy

TO THE MAXIMUM EXTENT PERMITTED BY LAW, THIS LIMITED WARRANTY AND THE REMEDIES SET FORTH ABOVE ARE EXCLUSIVE AND IN LIEU OF ALL OTHER WARRANTIES, REMEDIES AND CONDITIONS, WHETHER ORAL OR WRITTEN, EXPRESS OR IMPLIED. TO THE MAXIMUM EXTENT PERMITTED BY LAW, KRAMER ELECTRONICS SPECIFICALLY DISCLAIMS ANY AND ALL IMPLIED WARRANTIES, INCLUDING WITHOUT LIMITATION, WARRANTIES OF MERCHANTABILITY AND FITNESS FOR A PARTICULAR PURPOSE. IF KRAMER ELECTRONICS CANNOT LAWFULLY DISCLAIM OR EXCLUDE IMPLIED WARRANTIES UNDER APPLICABLE LAW, THEN ALL IMPLIED WARRANTIES COVERING THIS PRODUCT, INCLUDING WARRANTIES OF MERCHANTABILITY AND FITNESS FOR A PARTICULAR PURPOSE, SHALL APPLY TO THIS PRODUCT AS PROVIDED UNDER APPLICABLE LAW.

IF ANY PRODUCT TO WHICH THIS LIMITED WARRANTY APPLIES IS A "CONSUMER PRODUCT" UNDER THE MAGNUSON-MOSS WARRANTY ACT (15 U.S.C.A. §2301, ET SEQ.) OR OTHER APPLICABLE LAW, THE FOREGOING DISCLAIMER OF IMPLIED WARRANTIES SHALL NOT APPLY TO YOU, AND ALL IMPLIED WARRANTIES ON THIS PRODUCT, INCLUDING WARRANTIES OF MERCHANTABILITY AND FITNESS FOR THE PARTICULAR PURPOSE, SHALL APPLY AS PROVIDED UNDER APPLICABLE LAW.

### Other Conditions

This limited warranty gives you specific legal rights, and you may have other rights which vary from country to country or state to state.

This limited warranty is void if (i) the label bearing the serial number of this product has been removed or defaced, (ii) the product is not distributed by Kramer Electronics or (iii) this product is not purchased from an authorized Kramer Electronics reseller. If you are unsure whether a reseller is an authorized Kramer Electronics reseller, please visit our Web site at [www.kramerelectronics.com](http://www.kramerelectronics.com) or contact a Kramer Electronics office from the list at the end of this document.

Your rights under this limited warranty are not diminished if you do not complete and return the product registration form or complete and submit the online product registration form. Kramer Electronics thanks you for purchasing a Kramer Electronics product. We hope it will give you years of satisfaction.



For the latest information on our products and a list of Kramer distributors, visit our Web site where updates to this user manual may be found.

**We welcome your questions, comments, and feedback.**

Web site: [www.kramerelectronics.com](http://www.kramerelectronics.com)

E-mail: [info@kramerel.com](mailto:info@kramerel.com)

CE



**SAFETY WARNING**

Disconnect the unit from the power supply before opening and servicing



P/N: 2900-000386



Rev: 7