

Kramer Electronics, Ltd.



USER MANUAL

Model:

VP-8x8TP

8x8 UXGA/Audio Matrix Switcher

Contents

1	Introduction	1
2	Getting Started	1
2.1	Quick Start	1
3	Overview	3
3.1	Terminology Used in this User Manual	4
3.2	Shielded Twisted Pair and Unshielded Twisted Pair	4
3.3	Defining the EDID	5
4	Defining the VP-8x8TP 8x8 UXGA/Audio Matrix Switcher	6
5	Installing the VP-8x8TP in a Rack	9
6	Connecting and Configuring the VP-8x8TP 8x8 UXGA/Audio Matrix Switcher	10
6.1	Connecting the VP-8x8TP 8x8 UXGA/Audio Matrix Switcher	10
6.2	Connecting to the VP-8x8TP 8x8 UXGA/Audio Matrix Switcher via RS-485	11
6.2.1	Setting the RS-485 Bus Termination	12
6.2.2	Setting the RS-485 Bus Machine Number	12
6.3	Connecting to VP-8x8TP via the RS-232 Port	12
6.4	Configuring the Ethernet Port	12
6.4.1	Connecting via the Ethernet Port	12
6.4.2	Ethernet Port Configuration	14
6.5	Operating the VP-8x8TP 8x8 UXGA/Audio Matrix Switcher Remotely	16
6.6	Setting the Switching Delay Time	16
7	Operating the VP-8x8TP 8x8 UXGA/Audio Matrix Switcher	17
7.1	Switching Inputs and Outputs	17
7.1.1	Switching an Input to an Output	17
7.1.2	Switching an Input to all Outputs	17
7.1.3	Disconnecting an Input from an Output	17
7.1.4	Disconnecting all Inputs from Outputs	18
7.2	The 7-Segment Status Display Modes	18
7.2.1	Status Display Immediately After Power is Turned On	18
7.2.2	Status Display During Normal Operation	18
7.2.3	Status Display During Audio Level Setting	19
7.3	Confirming Settings	19
7.3.1	Toggling between the At Once and Confirm Modes	19
7.3.2	Confirming a Switching Action	20
7.4	Storing/Recalling Input-Output Configurations	20
7.4.1	Storing an Input-Output Configuration	20
7.4.2	Recalling an Input-Output Configuration	21
7.5	Locking the Front Panel	21
7.6	Choosing the Audio-Follow-Video or Breakaway Option	21
7.6.1	Setting the Audio-Follow-Video Option	22
7.6.2	Setting the Breakaway Option	22

7.7	Setting the Audio Input Gain	22
7.8	Using the IR Transmitter	23
8	Operating Multiple VP-8x8TP Units Remotely via RS-232	23
9	Operating the VP-8x8TP Remotely via your Web Browser	24
9.1	Connecting to the VP-8x8TP 8x8 UXGA/Audio Matrix Switcher via your Browser	25
9.2	The Main Switching Matrix Page	26
9.2.1	Switching an Input to an Output	27
9.2.2	Setting the AFV Mode	27
9.2.3	Operating in the Offline Mode	28
9.2.4	Storing and Recalling Setups	29
9.2.5	Locking the Front Panel Buttons	31
9.3	Audio Input Gain Control Page	31
9.4	The Configuration Page	32
10	EDID	33
11	Firmware Upgrade	33
12	Technical Specifications	34
13	Default Communication Parameters	34
14	Default EDID	35
15	Tables of Hex Codes for Serial Communication (Protocol 2000)	37
16	Kramer Protocol	38
16.1	Switching Protocols	38
16.1.1	Switching Protocols via the Front Panel Buttons	38
16.1.2	Switching Protocols via Protocol Commands	39
16.2	Kramer Protocol 3000	39
16.2.1	Protocol 3000 Syntax	39
16.2.2	Command Parts Details	40
16.3	Kramer Protocol 2000	46

Figures

Figure 1: VP-8x8TP 8x8 UXGA/Audio Matrix Switcher Front Panel	6
Figure 2: VP-8x8TP 8x8 UXGA/Audio Matrix Switcher Rear Panel	6
Figure 3: Connecting the VP-8x8TP 8x8 UXGA/Audio Matrix Switcher	10
Figure 4: The RS-485 TERM Dipswitch	12
Figure 5: Local Area Connection Properties Window	13
Figure 6: Internet Protocol (TCP/IP) Properties Window	14
Figure 7: Connect Window	15
Figure 8: Device Properties Window	16
Figure 9: Status Display Five Seconds After Turn On	18
Figure 10: Status Display During Normal Operation	18
Figure 11: Status Display Showing INPUT 3, Gain -4.5	19
Figure 12: Storing and Recalling using the Input-Output Buttons	20
Figure 13: Status Display Showing Audio Gain for Input 3, Gain -4.5	22

Figure 14: Control Configuration via RS-232 and RS-485	24
Figure 15: Java Test Page Success Message	24
Figure 16: Entering the IP Number in the Address Bar	25
Figure 17: The Loading Page	25
Figure 18: First Time Security Warning	26
Figure 19: Main Switching Matrix Page	26
Figure 20: Selecting a Switching Point on the Matrix	27
Figure 21: Switching an Input to an Output	27
Figure 22: AFV Mode Warning	28
Figure 23: AFV Mode Audio Channels Switched	28
Figure 24: Switching Audio in the Offline Mode	29
Figure 25: Exiting Offline Warning	29
Figure 26: Selecting Preset 07	30
Figure 27: Selecting Preset 03	30
Figure 28: Recalling a Preset in Offline Mode	31
Figure 29: Audio Gain Control Page	31
Figure 30: Selecting Audio Input Gain for Channel 2	32
Figure 31: Configuration Page	32

Tables

Table 1: Terminology Used in this Manual	4
Table 2: VP-8x8TP Front and Rear Panel Features	7
Table 3: Technical Specifications of the VP-8x8TP 8x8 UXGA/Audio Matrix Switcher	34
Table 4: Default Communication Parameters	34
Table 5: VP-8x8TP Video Signal Codes	36
Table 6: VP-8x8TP Audio Signal Codes	36
Table 7: VP-8x8TP Audio Input Gain Codes	37
Table 8: VP-8x8TP Hex Codes for Switching Video Channels	37
Table 9: VP-8x8TP Hex Codes for Switching Audio Channels	37
Table 10: VP-8x8TP Hex Codes for Increasing/Decreasing the Audio Input Gain	38
Table 11: VP-8x8TP Hex Codes for Setting the Audio Input Gain	38
Table 12: Instruction Codes for Protocol 3000	40
Table 13: Protocol Definitions	46
Table 14: Instruction Codes for Protocol 2000	47

1 Introduction

Welcome to Kramer Electronics! Since 1981, Kramer Electronics has been providing a world of unique, creative, and affordable solutions to the vast range of problems that confront the video, audio, presentation, and broadcasting professional on a daily basis. In recent years, we have redesigned and upgraded most of our line, making the best even better! Our 1,000-plus different models now appear in 11 groups¹ that are clearly defined by function.

Congratulations on purchasing your **VP-8x8TP** 8x8 UXGA/Audio Matrix Switcher, which is ideal for the following typical applications:

- Professional display systems requiring a true 8x8 computer graphics and audio matrix operation
- Long range multimedia and presentation source and acceptor selection

The package includes the following items:

- **VP-8x8TP** 8x8 UXGA/Audio Matrix Switcher
- **K-Router** Windows[®]-based Kramer control software²
- Kramer **RC-IR3** Infrared Remote Control Transmitter (including the required battery and a separate user manual⁴)
- Power cord³ and this user manual⁴

2 Getting Started

We recommend that you:

- Unpack the equipment carefully and save the original box and packaging materials for possible future shipment
- Review the contents of this user manual
- Use Kramer high performance high-resolution cables⁵

2.1 Quick Start

This quick start chart summarizes the basic setup and operation steps.

1 GROUP 1: Distribution Amplifiers; GROUP 2: Switchers and Matrix Switchers; GROUP 3: Control Systems; GROUP 4: Format/Standards Converters; GROUP 5: Range Extenders and Repeaters; GROUP 6: Specialty AV Products; GROUP 7: Scan Converters and Sealers; GROUP 8: Cables and Connectors; GROUP 9: Room Connectivity; GROUP 10: Accessories and Rack Adapters; GROUP 11: Sierra Products

2 Downloadable from our Web site at <http://www.kramerelectronics.com>

3 We recommend that you use only the power cord that is supplied with this machine

4 Download up-to-date Kramer user manuals from <http://www.kramerelectronics.com>

5 The complete list of Kramer cables is available at <http://www.kramerelectronics.com>

Step 1: Mount the machine - see section 5

Mount the machine in a rack or stick the 4 rubber feet to the underside



Step 2: Connect the inputs and outputs - see section 6

- 1 Connect the inputs
- 2 Connect the outputs
- 3 Optional - Connect a controller

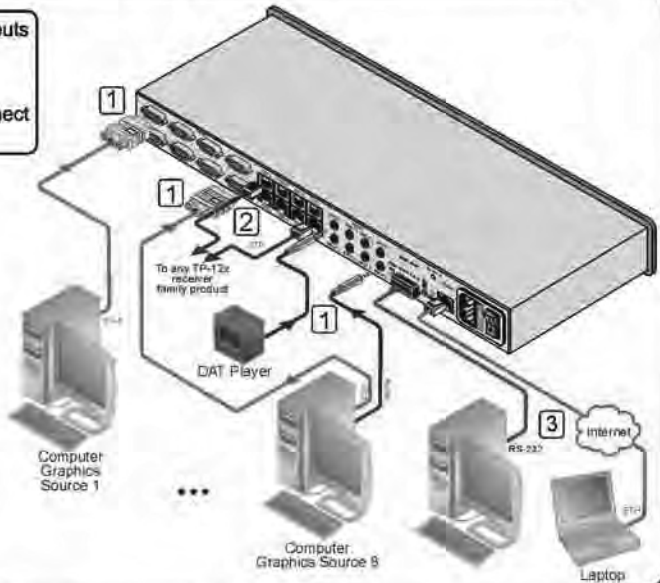

Step 3: Turn the power ON

Step 4: Operate the machine - see section 7

Use the SELECTOR buttons to switch the inputs to the outputs

(ALL) Connect a selected input to all the outputs; (OFF) disconnect an output from an input

VIDEO - Switching relates to the video signal
 AUDIO - Switching relates to the audio signal
 AFV - Audio follows video when switching

Increase or decrease the AUDIO LEVEL

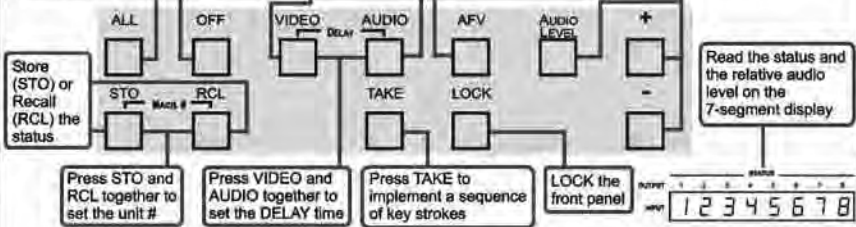

Operate via the front panel buttons, RS-232, RS-485 and/or the Ethernet

3 Overview

The **VP-8x8TP** is a high performance 8x8 computer graphics video and audio matrix switcher for high resolution video and stereo audio signals. The **VP-8x8TP** is HDTV compatible and lets you route any combination of inputs and outputs over TP (Twisted Pair) cable to compatible TP receivers.

In particular, the **VP-8x8TP 8x8 UXGA/Audio Matrix Switcher** features:

- Kramer's innovative integrated sync processing **Kr-isp**[®] technology that lets you achieve a sharp, stable image when the sync level is too low, by restoring the sync signal waveform
- Resolution up to UXGA (1600 x 1200), 1080p
- Support for component video with suitable breakout cables¹
- 16 preset memory locations for quick access to common video and audio configurations and audio gain status for each output
- Automatic detection of the connected input signals (the respective button lights)
- A delayed switching mode (ranging from 0 to 3.5sec²) for clean transitions (seamless switching) when switching between non-genlocked sources
- DC-coupled video inputs and outputs
- Audio-follow-video and breakaway options
- Eight stereo unbalanced audio input signals on 3.5mm mini jacks
- Eight RJ-45 STP/UTP output connectors
- Over 100m (330ft) transmission range between the switcher and the TP receiver
- Audio level control buttons for adjusting the signal level of each input
- Measurement and indication of the audio level for each input and output, in relative dB
- A TAKE button, which allows you to place multiple switches in a queue and then activate them simultaneously with one touch of this button
- A LOCK button to prevent tampering with the front panel

The **VP-8x8TP** can be controlled using the front panel buttons, or remotely via:

- RS-485 or RS-232 serial commands (using Kramer 2000 and 3000 Protocols) transmitted by a touch screen system, PC, or other serial controller
- The Kramer infrared remote control transmitter or infrared remote extension cable transmitter (optional)
- A Web browser over Ethernet

The **VP-8x8TP** is dependable, rugged, and fits into one vertical space (1U) of a standard 19" professional rack.

¹ For example, C-GM/5BM The complete list of Kramer cables is available at <http://www.kramerelectronics.com>

² In increments of 0.5sec

To achieve the best performance:

- Use only good quality connection cables¹ to avoid interference, deterioration in signal quality due to poor matching, and elevated noise levels (often associated with low quality cables)
- Avoid interference from neighboring electrical appliances that may adversely influence signal quality and position your Kramer **VP-8x8TP** away from moisture, excessive sunlight and dust

3.1 Terminology Used in this User Manual

Table 1 defines some terms that are used in this user manual.

Table 1: Terminology Used in this Manual

Term	Definition
802.3	The standard specification for Ethernet that is maintained by the Institute of Electrical and Electronics Engineers (IEEE).
Dynamic Host Configuration Protocol (DHCP)	Allows the network administrator to distribute IP addresses from a central point and automatically send a new IP address when an Ethernet point is plugged into a different network location.
Gateway	A network position serving as an entry to another network. On the Internet, a node or stopping point can be either a gateway node or a host (end-point) node.
IP Address	A 32-binary digit number that identifies each sender or receiver (within a network via a particular server or workstation) of data (HTML pages or e-mails) that is sent in packets across the Internet. Every device connected to an IP network must have a unique IP address. This address is used to reference the specific unit.
Local Area Network (LAN)	Computers sharing a common communications line or wireless link, which often share a server within a defined geographic area.
Media Access Control (MAC) Address	A computer's unique hardware number (or address) in a LAN or other network. On an Ethernet LAN, the (MAC) address is identical to the Ethernet address.
Transmission Control Protocol/Internet Protocol (TCP/IP)	The basic communication language or protocol of the Internet that breaks the message into appropriately sized packets for the network, and can be used as a communications protocol in an intranet or an extranet.

3.2 Shielded Twisted Pair and Unshielded Twisted Pair

We recommend that you use Shielded Twisted Pair (STP) cable. There are different grades of STP cable available, and we advise you to use the best quality STP cable that you can afford. Our non-skew-free cable, Kramer **BC-STP** is intended for digital signals and for analog signals where skewing is not an issue. For cases where skewing occurs, our UTP skew-free cable, Kramer **BC-XTP**, may be used. Bear in mind, though, that we advise using STP cables where possible, since the compliance to electromagnetic interference has been tested using STP cables.

Although Unshielded Twisted Pair (UTP) cable might be preferred for long range applications, UTP cable should be installed as far as possible from electric cables, motors, and so on, as these devices tend to create electromagnetic interference. However, since the use of UTP cable might not conform to electromagnetic standards, Kramer does not commit to meeting the standard with UTP cable.

¹ Available from Kramer Electronics on our Web site at <http://www.kramerelectronics.com>

3.3 Defining the EDID

The Extended Display Identification Data (EDID¹) is a data-structure, provided by a display, to describe its capabilities to a graphics card (that is connected to the display's source). The EDID enables the PC or laptop to "know" what kind of monitor is connected to the output. The EDID includes the manufacturer's name, the product type, the timing data supported by the display, the display size, luminance data and (for digital displays only) the pixel mapping data.

¹ Defined by a standard published by the Video Electronics Standards Association (VESA)

4 Defining the VP-8x8TP 8x8 UXGA/Audio Matrix Switcher

Figure 1 and Table 2 define the front panel of the **VP-8x8TP 8x8 UXGA/Audio Matrix Switcher**.

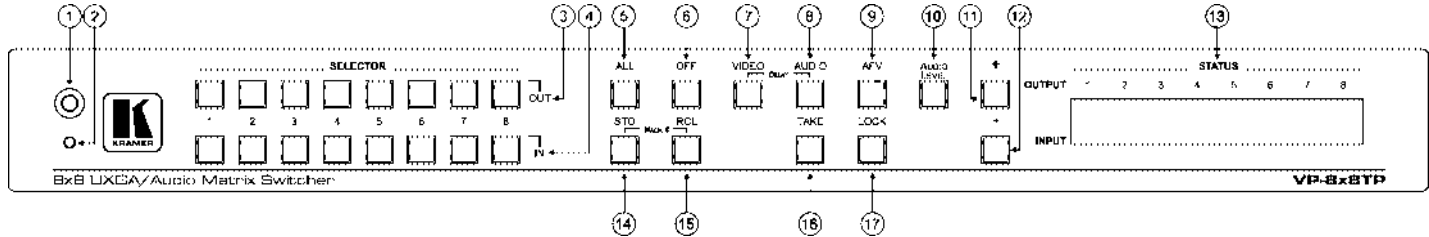

Figure 1: VP-8x8TP 8x8 UXGA/Audio Matrix Switcher Front Panel

Figure 2 and Table 2 define the rear panel of the **VP-8x8TP 8x8 UXGA/Audio Matrix Switcher**.

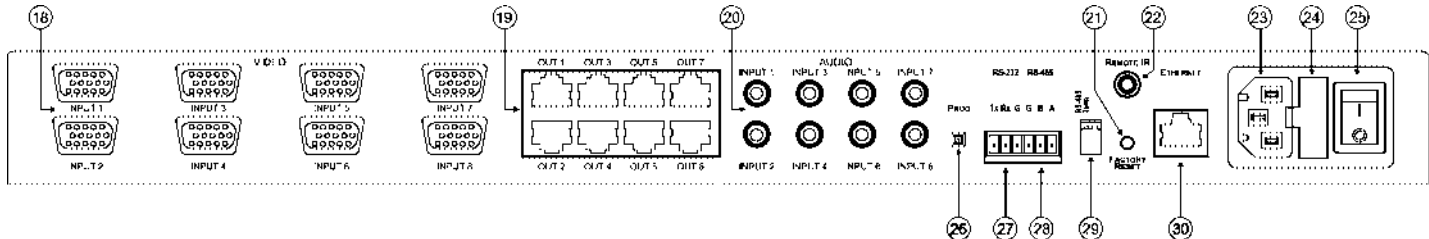

Figure 2: VP-8x8TP 8x8 UXGA/Audio Matrix Switcher Rear Panel

Table 2: VP-8x8TP Front and Rear Panel Features

#	Feature	Function	
1	IR Receiver	Receiver for the infrared remote control transmitter	
2	IR LED	LED lights yellow when the unit receives IR commands	
3	SELECTOR OUT Buttons	Press to select the output ¹ to which the input is switched	
4	SELECTOR IN Buttons	Press to select the input to switch to the output (after selecting an output). When a signal is detected on an input connector, the corresponding input button lights	
5	ALL Button	Press ALL followed by an INPUT button to connect that input to all outputs ²	
6	OFF Button	Press an OUTPUT button and then the OFF button to disconnect the selected output from the input. Press the ALL button and then the OFF button to disconnect all the outputs	
7	VIDEO Button	Press to modify video related actions ³	
8	AUDIO Button	Press to modify audio related actions ⁵	
9	AFV button	Press to make audio channels follow the video channels	
10	AUDIO LEVEL Button	Press to show the relative audio level on the STATUS display (see Section 7.1.2). Select an input, then use the + and – buttons to change the audio gain level	
11	AUDIO LEVEL	+ button	Press to increase the audio input gain ⁶ (first press Audio Level and then select an input)
12		– button	Press to decrease the audio input gain ⁶ (first press Audio Level and then select an input)
13	STATUS 7-segment Display	Displays either the input/output configuration, the audio gain setting or the firmware build and machine number (see Section 7.1.2)	
14	STO (Store) Button	Press STO followed by an INPUT/OUTPUT button to store the setting ⁷	
15	RCL (Recall) Button	Press the RCL button to cause the corresponding input/output button to recall a setup from the non-volatile memory. Press the RCL button again to implement the new status	
16	TAKE Button	Press TAKE to toggle between the Confirm mode ⁹ and the At Once mode (user confirmation per action is unnecessary). When in Confirm mode, press the TAKE button to implement a pending configuration	
17	LOCK Button	Press and hold to toggle locking of the front panel buttons	

1 From 1 to 8

2 For example, press ALL and then Input button # 2 to connect input # 2 to all the outputs

3 The VIDEO button lights when in breakaway mode and actions relate to video

4 See [Section 8](#)

5 The AUDIO button lights when in breakaway mode and actions relate to audio

6 In the case where the Audio Level button was pressed, and the audio level is shown on the Status 7-segment Status Display

7 For example, press STO and then the output button # 3 to store in Setup # 3, or the input button 4 to store in Setup 12

8 See [Section 6.2.2](#)

9 When in the Confirm mode, the TAKE button lights

Defining the VP-8x8TP 8x8 UXGA/Audio Matrix Switcher

#	Feature	Function
18	VIDEO INPUT 15-pin HD (F) UXGA Connectors	Connect to the video sources (from 1 to 8)
19	OUT RJ-45 Connectors	Connect to TP receivers (from 1 to 8), for example, TP-122
20	AUDIO INPUT 3.5mm Mini Jacks	Connect to the unbalanced stereo audio sources (from 1 to 8)
21	FACTORY RESET Button	Press and hold while powering up the unit to reset the audio, switching, EDID and Ethernet settings to their factory default values (see Table 4)
		IP Address: 192.168.1.39
		Mask: 255.255.255.0
		Gateway: 192.168.1.1
22	REMOTE IR Socket ¹	Connect to an external IR receiver unit for controlling the machine via an IR remote controller instead of using the front panel IR receiver ²
23	Power Connector Socket	Connect to the AC mains power
24	Power Connector Fuse	AC mains power fuse
25	Power Switch	Turns the AC mains power ON/OFF
26	PROG Button	Push in for "Program" to upgrade to the latest Kramer firmware via RS-232 (see Section 8), or release for "Normal" operation (the factory default)
27	RS-232 Terminal Block	Connect to a PC or remote controller (see Section 8)
28	RS-485 Terminal Block	Connect to another RS-485-equipped device for control (see Section 6.2)
29	RS-485 TERM DIP-switch	RS-485 bus termination ³ : ON to terminate with 120Ω, OFF for no termination (see Section 6.2.1)
30	ETHERNET Connector	Connect to a PC or other serial controller through the computer network for control (see Section 8)

¹ Covered by a cap. The 3.5mm mini connector at the end of the internal IR connection cable fits through this opening.

² Optional. Can be used instead of the front panel (built-in) IR receiver to remotely control the machine (only if the internal IR connection cable has been installed).

³ The first and the last units on the RS-485 line should be terminated (ON). Other units should be unterminated (OFF).

5 Installing the VP-8x8TP in a Rack

This section describes what to do before installing in a rack and how to rack mount the **VP-8x8TP**.

Before Installing in a Rack

Before installing in a rack, be sure that the environment is within the recommended range:

Operating temperature range	+5° to +45° C (41° to 113° F)
Operating humidity range	10 to 90% RHL, non-condensing
Storage temperature range	-20° to +70° C (-4° to 158° F)
Storage humidity range	5 to 95% RHL, non-condensing



CAUTION!

When installing on a 19" rack, avoid hazards by taking care that:

1. It is located within the recommended environmental conditions, as the operating ambient temperature of a closed or multi unit rack assembly may exceed the room ambient temperature.
2. Once rack mounted, enough air will still flow around the machine.
3. The machine is placed straight in the correct horizontal position.
4. You do not overload the circuit(s). When connecting the machine to the supply circuit, overloading the circuits might have a detrimental effect on overcurrent protection and supply wiring. Refer to the appropriate nameplate ratings for information. For example, for fuse replacement, see the value printed on the product label.
5. The machine is earthed (grounded) in a reliable way and is connected only to an electricity socket with grounding. Pay particular attention to situations where electricity is supplied indirectly (when the power cord is not plugged directly into the socket in the wall), for example, when using an extension cable or a power strip, and that you use only the power cord that is supplied with the machine.

How to Rack Mount

To rack-mount a machine:

1. Attach both ear brackets to the machine. To do so, remove the screws from each side of the machine (3 on each side), and replace those screws through the ear brackets.

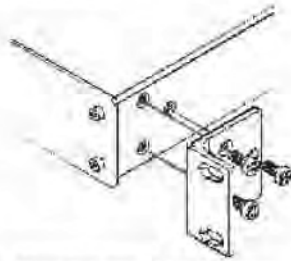

2. Place the ears of the machine against the rack rails, and insert the proper screws (not provided) through each of the four holes in the rack ears.

Note:

- In some models, the front panel may feature built-in rack ears
- Detachable rack ears can be removed for desktop use
- Always mount the machine in the rack before you attach any cables or connect the machine to the power
- If you are using a Kramer rack adapter kit (for a machine that is not 19"), see the Rack Adapters user manual for installation instructions (you can download it from <http://www.kramerelectronics.com>)

6 Connecting and Configuring the VP-8x8TP 8x8 UXGA/Audio Matrix Switcher

This section includes:

- Connecting the **VP-8x8TP 8x8 UXGA/Audio Matrix Switcher** (see [Section 6.1](#))
- Connecting to the **VP-8x8TP 8x8 UXGA/Audio Matrix Switcher** via **RS-485** (see [Section 6.2](#))
- Configuring the Ethernet Port (see [Section 6.4](#))
- Operating the **VP-8x8TP 8x8 UXGA/Audio Matrix Switcher** (see [Section 6.5](#))
- Setting the Switching Delay Time (see [Section 6.6](#))

6.1 Connecting the VP-8x8TP 8x8 UXGA/Audio Matrix Switcher

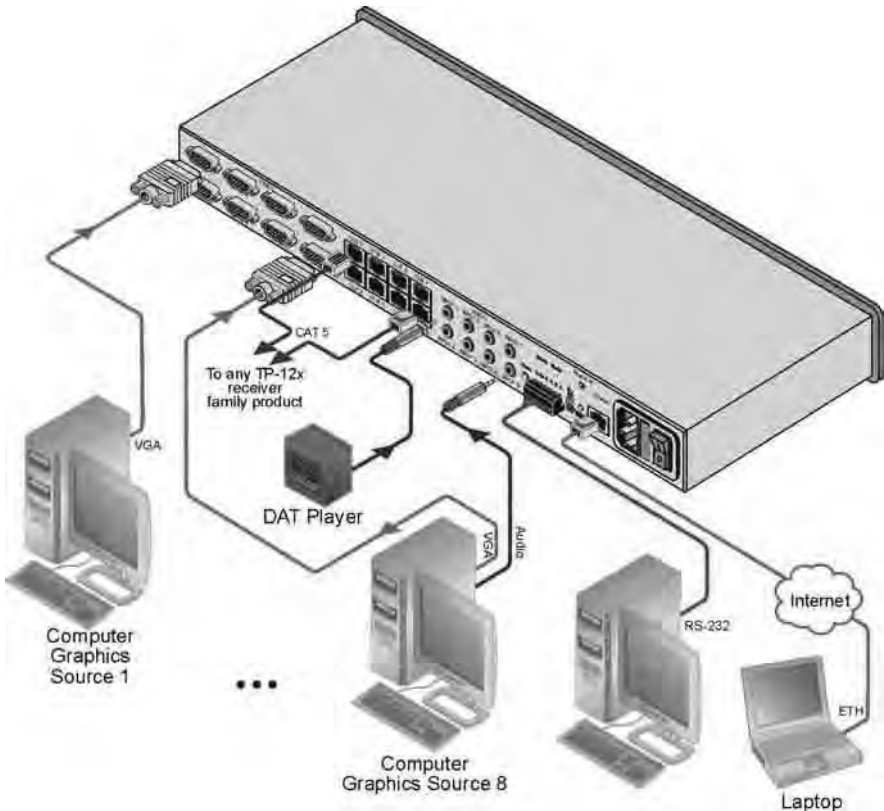

Figure 3: Connecting the VP-8x8TP 8x8 UXGA/Audio Matrix Switcher

To connect¹ the VP-8x8TP, as illustrated in the example² in [Figure 3](#):

1. Connect up to eight UXGA computer video graphics sources to the INPUT 15-pin HD connectors.
2. Connect up to eight unbalanced stereo audio sources (for example, audio sources of the computer and stereo audio sources) to the eight INPUT 3.5mm mini jacks.
3. Connect the eight OUTPUT RJ-45 connectors via STP cable to up to eight compatible TP receivers (for example, **TP-122**) via STP cable (with a range of more than 100m (330ft)).
4. Optional—Connect a PC and/or controller to the:
 - RS-232 port
 - RS-485 port (see [Section 6.2](#))
 - Ethernet (see [Section 6.2.1](#))
5. Connect the power cord³ (not shown in [Figure 3](#)).

6.2 Connecting to the VP-8x8TP 8x8 UXGA/Audio Matrix Switcher via RS-485

You can operate the **VP-8x8TP** via the RS-485 port from a distance of up to 1200 meters (3900ft) using any device equipped with an RS-485 port (for example, a PC). For successful communication, you must set the RS-485 machine number and bus termination correctly.

To connect a device with a RS-485 port to the VP-8x8TP:

1. Connect the **VP-8x8TP** to the device as follows:
 - Connect the TxD+ pin on the RS-485 port of the PC to the A (+) pin on the RS-485 port on the rear panel of the **VP-8x8TP**
 - Connect the TxD- pin on the RS-485 port of the PC to the B (-) pin on the RS-485 port on the rear panel of the **VP-8x8TP**
 - If shielded twisted pair cable is used, the shield may be connected to the G (ground) pin on the unit
2. Set the **VP-8x8TP** unit to a Machine number between 2 and 16 (see [Section 6.2.2](#)).
3. Set the RS-485 TERM DIP-switch On (see [Section 6.2.1](#)) if it is the only machine being controlled via the RS-485 bus.

¹ You do not need to connect all inputs and outputs

² Switch OFF the power on each device before connecting it to your VP-8x8TP. After connecting your VP-8x8TP, switch on its power and then switch on the power on each device. DO NOT push in the rear panel Flash Program “PROG” button, it is used only for upgrading to the latest Kramer firmware

³ We recommend that you use only the power cord that is supplied with this machine

6.2.1 Setting the RS-485 Bus Termination

Set the RS-485 TERM DIP-switch (see [Figure 4](#)) ON (for RS-485 Line Termination with 120Ω) if there is only one **VP-8x8TP** on the RS-485 bus. If there are multiple **VP-8x8TP** units on the RS-485 bus, only the first and last units on the RS-485 bus termination should be set to ON.

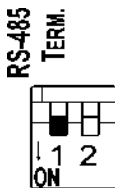

Figure 4: The RS-485 TERM Dipswitch

6.2.2 Setting the RS-485 Bus Machine Number

The Machine number determines the position of a **VP-8x8TP** on the RS-485 bus when connecting multiple units. Each **VP-8x8TP** must be set to a unique number.

To set the Machine number:

1. Press the STO and RCL buttons simultaneously.
The 7-segment display shows the current machine number.
2. Use the + and – buttons to set the Machine number as required.
3. Press the TAKE button to exit the Machine number mode.

6.3 Connecting to VP-8x8TP via the RS-232 Port

You can connect to the **VP-8x8TP** via an RS-232 connection using, for example, a PC.

To connect to the VP-8x8TP via RS-232:

- Connect the RS-232 9-pin D-sub port on the PC to the 3-pin terminal block on the **VP-8x8TP** (pin 2 to TX, pin 3 to RX, pin 5 to GND)

6.4 Configuring the Ethernet Port

To configure the Ethernet port, connect your PC to the **VP-8x8TP** via either the Ethernet port (see [Section 6.4.1](#)) or via a serial port. Once the machine is connected via either of these methods, you can configure the Ethernet port.

6.4.1 Connecting via the Ethernet Port

You can connect to the **VP-8x8TP** via the Ethernet port in either of the following ways:

- Direct connection to the PC using a crossover cable (see [Section 6.4.1.1](#))
- Connection via a network hub, switch, or router using a straight-through cable (see [Section 6.4.1.2](#))

6.4.1.1 Connecting the Ethernet Port Directly to a PC

You can connect the Ethernet port of the machine to the Ethernet port on your PC, via a crossover cable with RJ-45 connectors.

This type of connection is recommended for identification of the factory default IP Address¹ of the **VP-8x8TP** during the initial configuration

After connecting the Ethernet port, configure your PC as follows:

1. Click **Start > Control Panel**.
2. Double-click **Network Connections**.
3. Right-click, and from the menu select **Properties**.
The **Local Area Connection Properties** window appears.
4. Select **Internet Protocol (TCP/IP)** (see [Figure 5](#)).

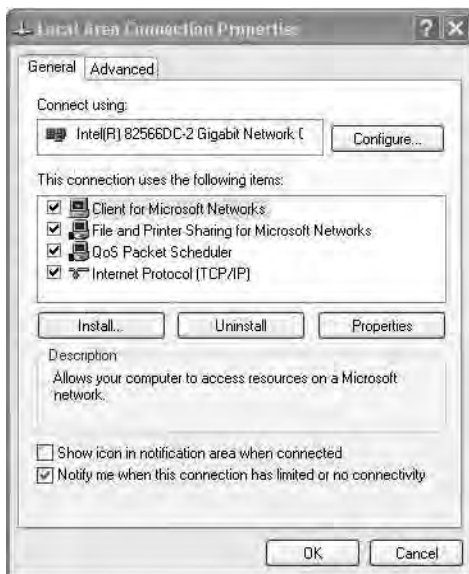

Figure 5: Local Area Connection Properties Window

5. Click the **Properties** button.
6. Select **Use the following IP address**, and fill in the details as shown in [Figure 6](#).

¹ The default IP address is 192.168.1.39

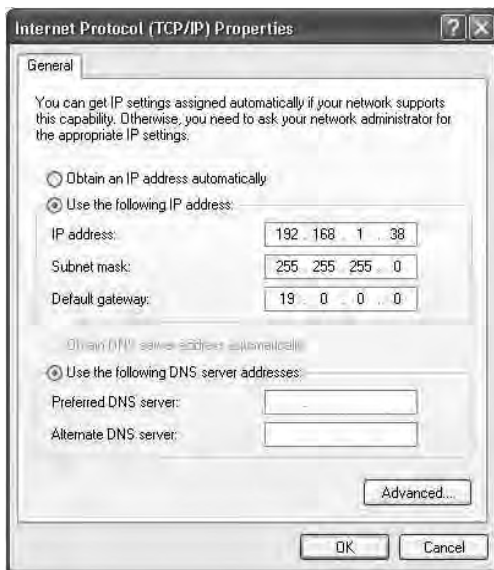

Figure 6: Internet Protocol (TCP/IP) Properties Window

7. Click **OK**.

6.4.1.2 Connecting the ETHERNET Port via a Network Hub, Switch, or Router

You can connect to the Ethernet port of the **VP-8x8TP** to the Ethernet port on a network hub, switch, or router, via a straight-through cable with RJ-45 connectors. Once connected, follow the steps in [Section 6.4.1.1](#).

6.4.2 Ethernet Port Configuration

To configure the Ethernet port on the **VP-8x8TP**, download the **P3K Wizard** software¹ to your PC, extract the files to a folder, and install the software.

To configure the VP-8x8TP Ethernet port:

1. Click **Start > All Programs > Kramer > P3K Wizard**
The **P3K Wizard** window appears.
2. Click **Connect**.
The **Connect** window appears.

¹ Available from <http://www.kramerelectronics.com>

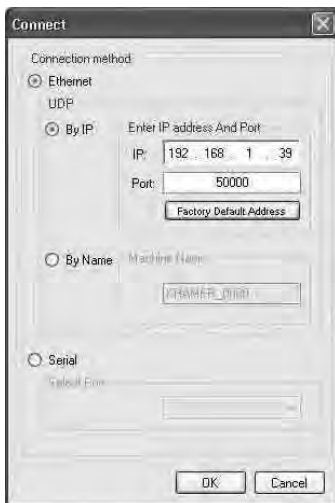

Figure 7: Connect Window

3. Select one of the following methods to connect to the Ethernet port of the **VP-8x8TP**:
 - Ethernet, if you are connected via an Ethernet cable. Enter the IP address¹ or the machine name
The default IP address is 192.168.1.39 and the default name for the unit is KRAMER_XXXX²
 - Serial, if you are connected via a serial port. Select the COM port from the **Select Port** drop-down list
4. Click **OK**.
The **Device Properties** window appears.

¹ The default IP address is 192.168.1.39

² The four digits are the last four digits of the machine's serial number

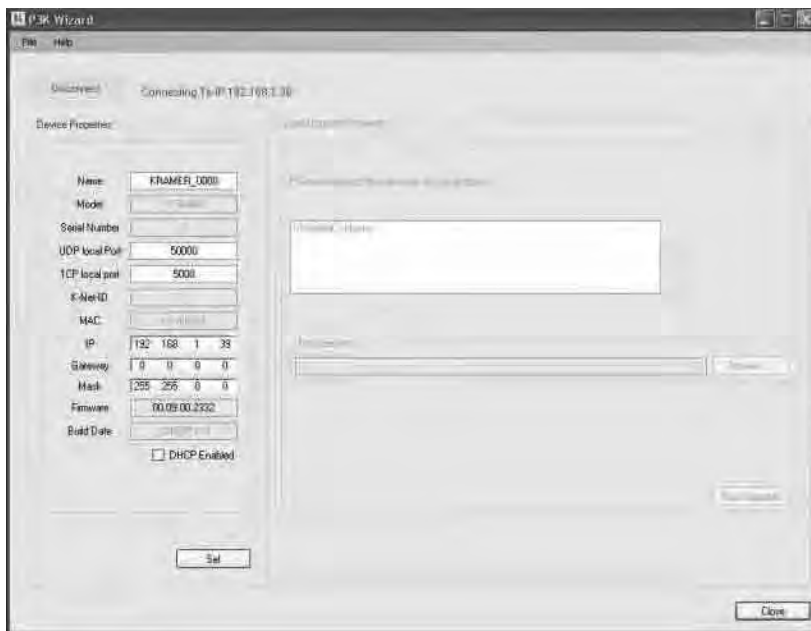

Figure 8: Device Properties Window

5. Make the required changes.
6. Click **Set** to save changes, or click **Close** to exit without saving the changes.

6.5 Operating the VP-8x8TP 8x8 UXGA/Audio Matrix Switcher Remotely

You can operate the **VP-8x8TP** remotely via RS-232, RS-485, and/or Ethernet using the Kramer K-Router application.

If you are operating a standalone unit via RS-232 or the Ethernet, configure the unit as Machine number 1 (see [Section 6.2.2](#)).

6.6 Setting the Switching Delay Time

You can achieve clean transitions when switching between non-genlocked sources by setting the delay time—ranging from 0sec to 3.5sec¹. The factory default delay is 0 seconds.

To set the delay time:

1. Press the VIDEO and AUDIO front panel buttons simultaneously. The 7-segment display shows the current switching delay time.
2. Use the + and – front panel buttons to set the delay time as required.
3. To exit the Delay mode, press the TAKE front panel button.

¹ In increments of 0.5sec

7 Operating the VP-8x8TP 8x8 UXGA/Audio Matrix Switcher

This section includes:

- Switching Inputs and Output (see [Section 7.1](#))
- The 7-segment Display Modes (see [Section 7.2](#))
- Confirming Settings (see [Section 7.3](#))
- Storing/Recalling Input-Output Configurations (see [Section 7.4](#))
- Locking the Front Panel (see [Section 7.5](#))
- Choosing the Audio-Follow-Video or Breakaway Option (see [Section 7.6](#))
- Setting the Audio Input Gain (see [Section 7.7](#))
- Using the IR Transmitter (see [Section 7.8](#))

7.1 Switching Inputs and Outputs

7.1.1 Switching an Input to an Output

To switch an input to an output:

1. Press the required OUTPUT button.
The input number below the selected output on the INPUT 7-segment display flashes.
2. Press an INPUT button to select the input to switch to the output.
The selected input number appears on the 7-segment display.

Incomplete operations on the **VP-8x8TP** timeout after 15 seconds

7.1.2 Switching an Input to all Outputs

To switch an input to all outputs:

1. Press the ALL button.
The 7-segment display flashes.
2. Press an INPUT button to select the input to switch to all outputs.
The selected input is switched to all outputs and the selected input appears on all outputs of the 7-segment display.

7.1.3 Disconnecting an Input from an Output

To disconnect an input from an output:

1. Press the required OUTPUT button.
The selected output flashes on the 7-segment display.
2. Press the OFF button.
The selected output is disconnected and displays 0 on the 7-segment display.

7.1.4 Disconnecting all Inputs from Outputs

To disconnect all inputs from outputs:

1. Press the ALL button.
The 7-segment display flashes.
2. Press the OFF button.
All inputs are disconnected from the outputs and display 0 on the 7-segment display.

7.2 The 7-Segment Status Display Modes

This section includes:

- Status Display Immediately After Power is Turned On (see [Section 7.2.1](#))
- Status Display During Normal Operation (see [Section 7.2.2](#))
- Status Display During Audio Level Setting (see [Section 7.2.3](#))

7.2.1 Status Display Immediately After Power is Turned On

Immediately after the unit is turned on, the status display shows the firmware build and machine number (see [Figure 9](#)).

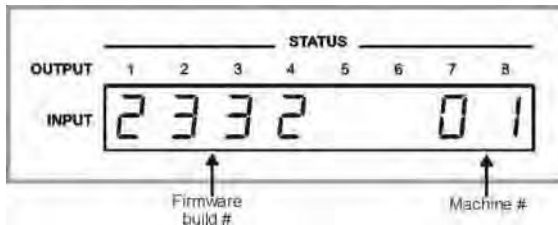

Figure 9: Status Display Five Seconds After Turn On

7.2.2 Status Display During Normal Operation

During normal operation, the STATUS display shows which inputs are switched to which outputs (an example is shown in [Figure 10](#)).

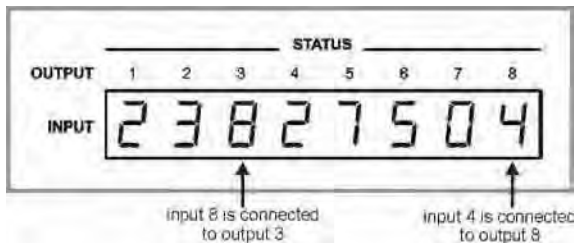

Figure 10: Status Display During Normal Operation

In the VIDEO mode, the display shows the video signal configuration. In the AUDIO mode, the display shows the audio signal configuration. In the AFV mode

(see [Section 7.6.1](#)), the display is for both signal configurations¹.

7.2.3 Status Display During Audio Level Setting

During audio gain level setting, the Status display indicates:

- Which channel number is selected (in this example, 3)
- The current gain setting in 0.5dB increments. The 0.5dB is indicated by the period following the 4 (in this example, **-04.** means **-4.5**).

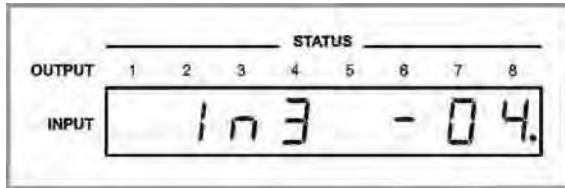

Figure 11: Status Display Showing INPUT 3, Gain -4.5

To set the audio gain, see [Section 7.7](#).

7.3 Confirming Settings

You can choose to work in the At Once or the Confirm mode.

In the At Once mode (TAKE button does not light):

- Pressing an OUT-IN combination implements the switch immediately
- You save time as execution is immediate and actions require no user confirmation
- No protection is offered to allow the correction of an erroneous action before it is implemented

In the Confirm mode (TAKE button lights):

- You can key-in several actions and then confirm them by pressing the TAKE button, to simultaneously activate the multiple switches
- Every action requires user confirmation, protecting against erroneous switching
- Execution is implemented only after the user confirms the action²

7.3.1 Toggling between the At Once and Confirm Modes

To toggle between the At Once and Confirm modes:

1. Press the TAKE button to toggle from the At Once mode (in which case the TAKE button does not light) to the Confirm mode (in which case the TAKE button lights).

Actions now require user confirmation and the TAKE button lights.

¹ In AFV mode, the audio and video configurations are the same

² The action times-out if you do not press the TAKE button within 40 seconds

2. Press the lit TAKE button to toggle from the Confirm mode back to the At Once mode.
Actions no longer require user confirmation and the TAKE button no longer lights.

7.3.2 Confirming a Switching Action

To confirm a switching configuration change (in the Confirm mode):

1. Press an OUTPUT-INPUT combination.
The corresponding 7-segment display flashes with the new value. The TAKE button also flashes.
2. Press the flashing TAKE button to confirm the action.
The corresponding 7-segment display no longer flashes. The TAKE button flashes.

To confirm several actions (in the Confirm mode):

1. Press each OUTPUT-INPUT combination in sequence.
The corresponding 7-segment display flashes. The TAKE button also flashes.
2. Press the flashing TAKE button to confirm all the actions.
The corresponding 7-segment display no longer flashes. The TAKE button lights.

7.4 Storing/Recalling Input-Output Configurations

You can store and recall up to 16 input-output configuration setups¹ using the eight OUTPUT buttons and the eight INPUT buttons on the front panel (see [Figure 12](#)).

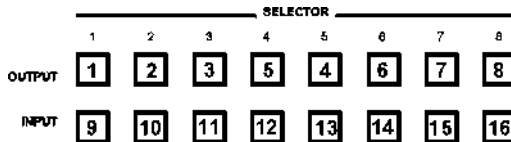

Figure 12: Storing and Recalling using the Input-Output Buttons

7.4.1 Storing an Input-Output Configuration

To store the current status in memory:

1. Press the STO button.
The STO button flashes.
2. Press one of the 16 INPUT/OUTPUT buttons (this will be the setup # in which the current status is stored).
3. If in the Confirm mode, press the flashing TAKE button to confirm the action.
The memory stores the data at that reference.

¹ You can store and recall audio and video configurations and audio gain data

7.4.2 Recalling an Input-Output Configuration

To recall an input-output configuration:

1. Press the RCL button.
The RCL button blinks.
2. Press the appropriate INPUT/OUTPUT button (the button # corresponding to the setup #). If in the Confirm mode, that setup configuration flashes in the Status display together with the RCL button and the TAKE button, and is only be implemented after pressing the TAKE button.
The memory recalls the stored data from that reference.

Tip: If you cannot remember which of the 16-input-output configurations is the one that you want, set the **VP-8x8TP** to the Confirm mode and manually scan¹ all the input/output configurations until you locate it.

7.5 Locking the Front Panel

To prevent changing the settings accidentally or tampering with the unit via the front panel buttons, lock² your **VP-8x8TP**. Unlocking releases the protection mechanism.

To lock the VP-8x8TP:

- Press and hold the LOCK button for more than two seconds until the LOCK button is lit.
The front panel is locked. Pressing a button has no effect other than to cause the LOCK button to flash³

To unlock the VP-8x8TP:

- Press and hold the lit LOCK button for more than two seconds, until the LOCK button is no longer lit
The front panel is unlocked

7.6 Choosing the Audio-Follow-Video or Breakaway Option

You can switch stereo audio signals in one of two ways, either:

- Audio-follow-video (AFV), in which all operations relate to both the video and the audio channels
- Breakaway, in which video and audio channels switch independently

¹ By pressing the RCL button followed by the INPUT/OUTPUT buttons

² Even when the front panel is locked you can still operate via RS-232 or RS-485, as well as via the Kramer RC-IR3 infrared remote control transmitter

³ Warning that you need to unlock to regain control via the front panel

7.6.1 Setting the Audio-Follow-Video Option

To set the Audio-follow-video (AFV) option, press the AFV button. One of the following occurs:

- If the AUDIO and VIDEO configurations are the same, then the AFV button lights. The audio follows the video
- If the AUDIO differs from the VIDEO, then the TAKE and the AUDIO buttons flash. Also, the audio outputs of the STATUS display which change, flash¹. Press the TAKE button to confirm the modification. The audio follows the video

7.6.2 Setting the Breakaway Option

To set the Breakaway option:

- Press either the AUDIO (for audio control only) or the VIDEO (for video control only) button. One of the following occurs:
 - If the AUDIO button lights, switching operations relate to Audio
 - If the VIDEO button lights, switching operations relate to Video

The STATUS window displays audio or video settings according to your selection.

7.7 Setting the Audio Input Gain

The factory default audio input gain is set to 0dB. An audio gain value of 0dB indicates that the output signal value is identical to the input signal value. When increasing/decreasing the audio gain, the output signal level is higher/lower than the input signal level.

The audio gain for each input can be set independently².

To set the audio gain of an input:

1. Press the AUDIO LEVEL button.
2. Press the required INPUT SELECTOR button.
The selected input button flashes. The display indicates which INPUT is selected and the current level setting for the input (see [Figure 13](#)).

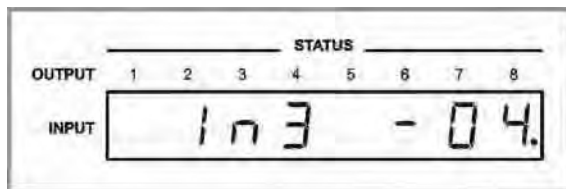

Figure 13: Status Display Showing Audio Gain for Input 3, Gain -0.4

¹ This warns that you are about to modify the audio configuration for AFV operation

² The input level ranges from -99 to +20

3. Press either the (+) button or the minus (-) button to increase or decrease respectively the audio gain setting.
The display changes accordingly.
4. Press the AUDIO LEVEL button to exit the gain level setting mode. If no button is pressed for 40 seconds, the **VP-8x8TP** automatically exits the gain level setting mode and the display reverts to normal operation.

7.8 Using the IR Transmitter

You can use the **RC-IR3** IR transmitter to control the machine via the built-in IR receiver on the front panel or, instead, via an optional external IR receiver¹. The external IR receiver can be located up to 15m (49ft) away from the machine. This distance can be extended to up to 60m (196ft) when used with three extension cables²

Before using the external IR receiver, be sure to arrange for your Kramer dealer to insert the internal IR connection cable³ with the 3.5mm mini connector that fits into the REMOTE IR opening on the rear panel. Connect the external IR receiver to the REMOTE IR 3.5mm mini connector.

8 Operating Multiple VP-8x8TP Units Remotely via RS-232

You can operate up to 16 **VP-8x8TP** units remotely via the RS-485 bus with control from a PC or serial controller equipped with an RS-232 interface⁴.

To operate up to 16 VP-8x8TP units remotely via RS-485 (see [Figure 14](#)):

1. Connect the sources and acceptors to the **VP-8x8TP** (see [Section 6.1](#)).
2. Connect the RS-232 port of the first **VP-8x8TP** unit to the PC or serial controller.
3. Connect the RS-485 port on the first **VP-8x8TP** to the RS-485 port on the second **VP-8x8TP** unit, and so on (see [Section 6.2](#)), connecting all the RS-485 ports.
4. Set the Machine number of the first **VP-8x8TP** to Machine number 1 (see [Section 6.2.2](#)).
5. Set the other **VP-8x8TP** units to be Machine numbers between 2 and 16.
6. On the first and last **VP-8x8TP** units, set the RS-485 TERM Dipswitch ON (terminating the RS-485 line at 120Ω) (see [Section 6.2](#)).
7. On all other **VP-8x8TP** units, set the RS-485 TERM Dipswitch OFF.

1 Model: C-A35M/IRR-50

2 Model: C-A35M/A35F-50

3 P/N: 505-70434010-S

4 Alternatively, the Ethernet port can be used for PC control (instead of RS-232)

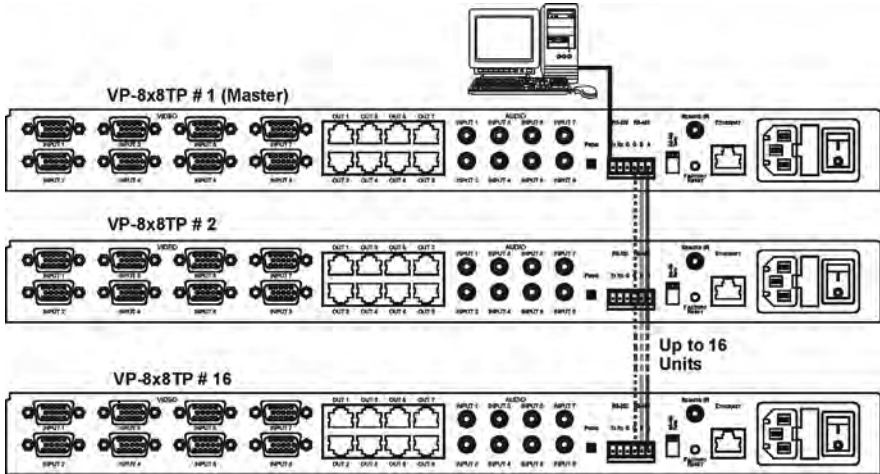

Figure 14: Control Configuration via RS-232 and RS-485

9 Operating the VP-8x8TP Remotely via your Web Browser

You can remotely operate the **VP-8x8TP** using a Web browser via the Ethernet connection (see [Section 9.1](#)). To be able to do so, you must use a supported Web browser; Microsoft (V6.0 and higher), Chrome, Firefox (V3.0 and higher).

To check that Java is installed and running, browse to:

<http://www.java.com/en/download/help/testvm.xml>

This page runs a test and displays a Java success (see [Figure 15](#)) or failure message.

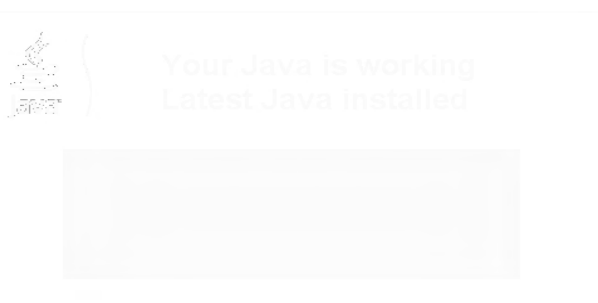

Figure 15: Java Test Page Success Message

If you do not see the success message, follow the instructions on the page to:

- Load and enable Java
- Enable Javascript in your browser

9.1 Connecting to the VP-8x8TP 8x8 UXGA/Audio Matrix Switcher via your Browser

Make sure that your PC is connected via a network to the **VP-8x8TP** and do the following:

1. Open your Internet browser.
2. Enter the unit's IP number (for the default IP address, see [Table 2](#)) or name in the Address bar of your browser.
If you are using DHCP, you have to enter the name.

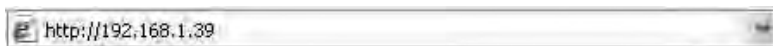

Figure 16: Entering the IP Number in the Address Bar

The Loading page appears.



Figure 17: The Loading Page

The first time that you run the Kramer applet a security warning appears.



Figure 18: First Time Security Warning

3. Click **Run**.

The main switching control page is displayed which shows a graphical representation of the front panel (see [Figure 19](#)).

There are three remote operation Web pages:

- Main switching matrix (see [Section 9.2](#))
- Audio gain control (see [Section 9.3](#))
- Configuration (see [Section 9.4](#))

Select a page by clicking on the relevant link on the left hand side of the window.

9.2 The Main Switching Matrix Page

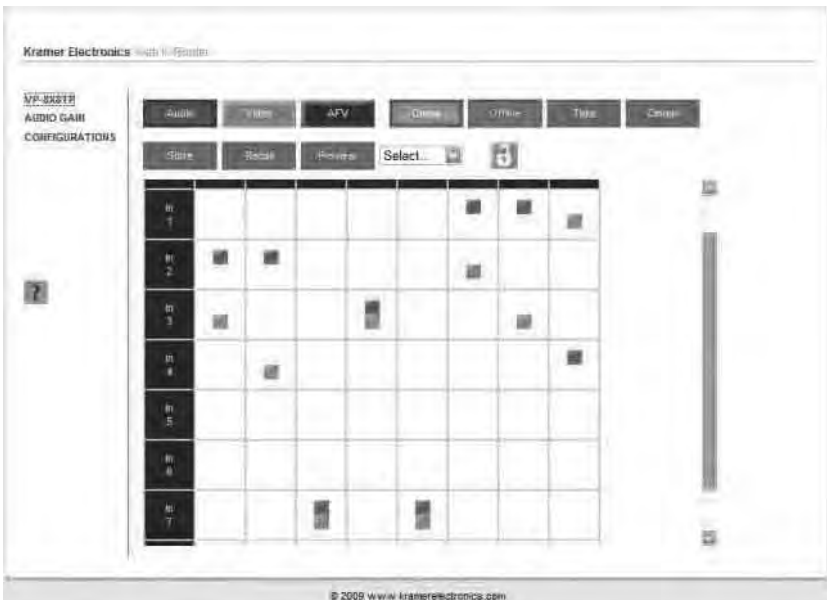

Figure 19: Main Switching Matrix Page

The main switching matrix page allows you to:

- Switch any audio/video input to any/all outputs independently (see [Section 9.2.1](#))
- Set the audio to operate in AFV (Audio Follow Video) mode (see [Section 9.2.2](#))
- Operate the unit in the Offline mode (see [Section 9.2.3](#))
- Use presets to store and recall switching configurations (see [Section 9.2.4](#))
- Lock or unlock the unit's front panel buttons (see [Section 9.2.5](#))

9.2.1 Switching an Input to an Output

To switch an input to an output, for example, video input 1 to video output 4:

1. Click the blue **Video** button.
The button outline becomes dark. Actions now relate to video channels.
2. Click the required point within the switching matrix grid (In 1, Out 4).

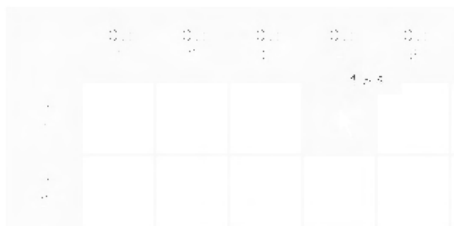



Figure 20: Selecting a Switching Point on the Matrix

A blue video icon  appears indicating that the video channel is switched to In 1 and Out 4.

	Out 1	Out 2	Out 3	Out 4	Out 5
In 1					
In 2					

Figure 21: Switching an Input to an Output

3. Repeat the above steps for each video and audio (clicking the purple **Audio** button) channel that you want to switch.

9.2.2 Setting the AFV Mode

Audio channel In 1 is currently switched to Out 4.

To set the AFV mode:

1. Click the **AFV** button.
The following warning appears.

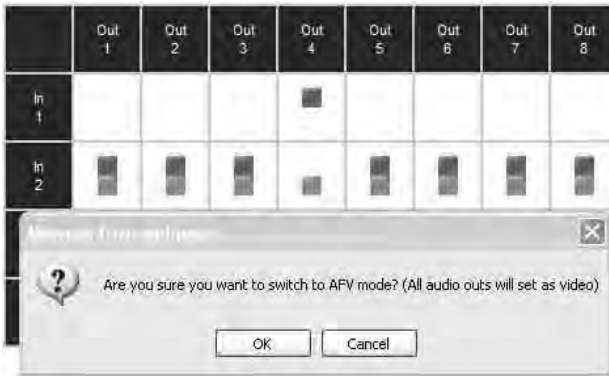

Figure 22: AFV Mode Warning

2. Click **OK**.
The **AFV** button outline becomes dark.
All audio channels are switched according to the corresponding video channels. In this example, audio channel In 2 is now switched to Out 4.

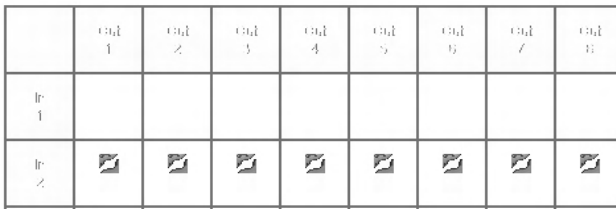



Figure 23: AFV Mode Audio Channels Switched

All configuration changes now switch audio and video simultaneously.

9.2.3 Operating in the Offline Mode

By default, the unit operates in the At-Once mode, meaning that any switching changes take effect immediately. In the Offline mode, changes only take effect when you press the **Take** button.

To operate in the Offline mode:

1. Click the red **Offline** button.
The button outline becomes dark.
2. Click the required point in the switching matrix grid (In 1, Out 5).
The audio/video indicator icon outline  (in this example, audio) appears, and the **Take** and **Cancel** buttons change from gray to dark blue.

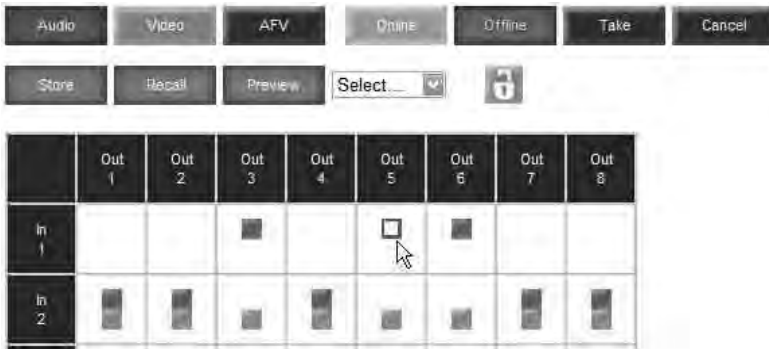

Figure 24: Switching Audio in the Offline Mode

3. If required, repeat Step 2 for several audio/video channels.
 4. Click either **Take** to accept the change or **Cancel**.
 5. Click the **Online** button to exit the Offline mode.
- If you have made any changes since clicking the **Take** button, the exiting Offline warning appears.

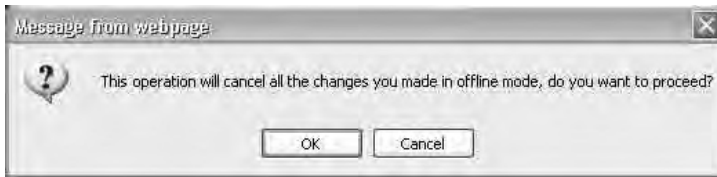

Figure 25: Exiting Offline Warning

9.2.4 Storing and Recalling Setups

You can store switching configurations in presets and recall them at any time.

To store a switching configuration:

1. From the Preset drop-down list, select a preset (in this example, Preset 07). Presets that contain a configuration are displayed with a blue background; presets with no configuration have a white background. When you select a preset, the **Store** button changes from gray to dark blue.

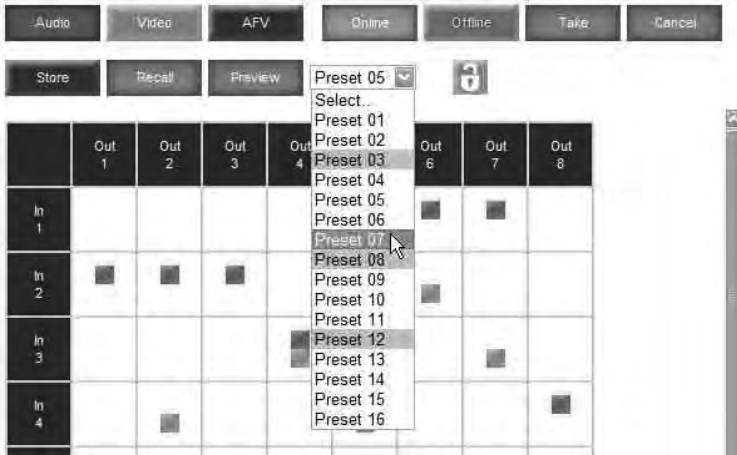

Figure 26: Selecting Preset 07

2. Click **Store**.
A confirmation message appears.
3. Click **OK**.
The configuration is stored in Preset 07.

To recall a setup:

1. From the Preset drop-down list, select a preset (in this example, Preset 03). Presets that contain a configuration are displayed with a blue background; presets with no configuration have a white background. When you select a preset that contains a configuration, the **Recall** button changes from gray to dark blue.

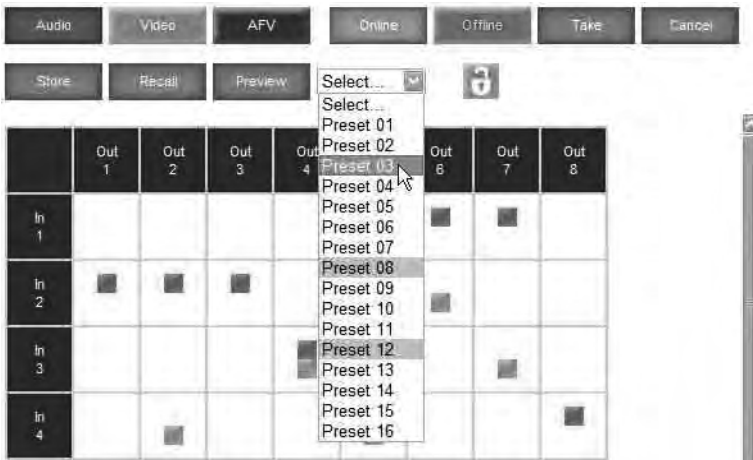

Figure 27: Selecting Preset 03

2. Click **Recall**.
A confirmation message appears.
3. Click **OK**.
The configuration from Preset 03 is loaded.

Note: You can also recall a preset in the Offline mode (see [Figure 29](#)) and make it active when you press the **Take** button (see [Section 9.2.3](#)).

	Ch 1	Ch 2	Ch 3	Ch 4	Ch 5	Ch 6	Ch 7	Ch 8
Pr 1								
Pr 2								
Pr 3								
Pr 4								

Figure 28: Recalling a Preset in Offline Mode

9.2.5 Locking the Front Panel Buttons

You can lock the front panel buttons to prevent tampering.

To lock the front panel buttons:

- Click the padlock icon 

Note: Locking the front panel buttons does not disable remote operation of the unit via Ethernet, RS-232 or RS-485.

9.3 Audio Input Gain Control Page

The Audio Gain page lets you set the gain for each of the input channels independently.



Figure 29: Audio Gain Control Page

To change the audio gain (in this example, input gain for channel 2):

1. From the Input Gain drop-down list, click 02.

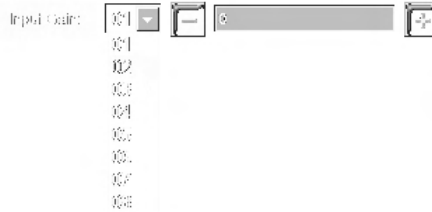

Figure 30: Selecting Audio Input Gain for Channel 2

- Click the – or + button to decrease or increase the gain. Hold the – or + button down to cycle through the values.

Note: Each click increments/decrements the value by 0.5. To change the gain by a whole number, you must click the +/- button twice.

9.4 The Configuration Page

The Configuration page lets you edit the IP-related settings and only view the others. Editable fields have a white background.

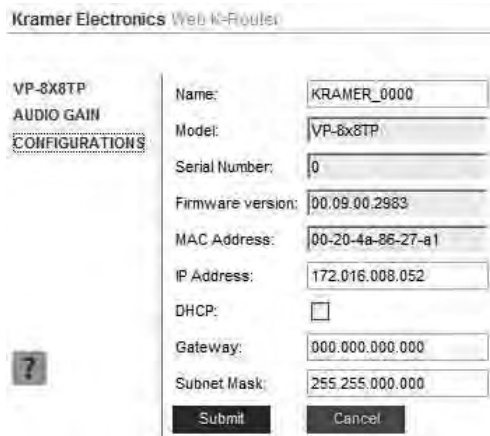

Figure 31: Configuration Page

The following IP-related settings can be edited:

- Machine name
- Fixed IP Address/DHCP
- Gateway
- Subnet Mask

The following fields can be viewed:

- Model
- Serial Number

- Firmware Version
- MAC Address

To edit the IP-related settings:

1. Edit the required field.
2. Click **Submit**.
The Network Settings confirmation message appears.
3. Click **OK**.
A message appears showing that the settings have been successfully changed.
4. If the IP address was changed or you selected DHCP, reload the Web page using the new name or IP address.

10 EDID

Each input on the **VP-8x8TP** has a factory default EDID loaded (see [Section 14](#)). The EDID for each input can be changed independently by uploading an EDID binary file to each input via the RS-232 port using Kramer EDID Sender software¹.

11 Firmware Upgrade

For instructions on upgrading the firmware, see the *Updating the Firmware Using the P3K Software* document.

The latest version of firmware and installation instructions can be downloaded from the Kramer Web site at www.kramerelectronics.com.

¹ Available for download from <http://www.kramerelectronics.com>

12 Technical Specifications

Technical specifications of the **VP-8x8TP** are shown in [Table 3](#).

Table 3: Technical Specifications¹ of the VP-8x8TP 8x8 UXGA/Audio Matrix Switcher

INPUTS:	8 VGA on 15-pin HD connectors (VGA through UXGA) 8 unbalanced stereo audio on 3.5mm mini jacks	
OUTPUTS:	8 RJ-45 connectors	
MAX. OUTPUT LEVEL:	VIDEO: 1 9Vpp	AUDIO: 3Vpp
RESOLUTION:	Up to UXGA, 1080p	
AUDIO BANDWIDTH:	18kHz (-3dB)	
DIFF. GAIN:	1.8%	
DIFF. PHASE:	0.3Deg	
K-FACTOR:	<0.05%	
S/N RATIO:	VIDEO: 60dB @5MHz	AUDIO: 81dB @1kHz
CROSSTALK (all hostile):	VIDEO: -46dB @5MHz	AUDIO: <-72dB @1kHz
CONTROLS:	Front panel buttons, RS-232, RS-485, Ethernet, Infrared	
COUPLING:	VIDEO: AC	AUDIO: AC
AUDIO THD + NOISE:	0.035% @1kHz	
AUDIO 2nd HARMONIC:	0.002% @1kHz	
TRANSMISSION RANGE:	>100m (330ft)	
POWER SOURCE:	100-240V AC, 68VA	
DIMENSIONS:	19" x 7 5" x 1U (48.3cm x 19cm x 1U) W, D, H	
WEIGHT:	2.6kg (5.7lbs) approx	
ACCESSORIES:	Power cord, Windows [®] -based control software, external remote IR receiver cable ²	

13 Default Communication Parameters

[Table 4](#) lists the default communication parameters as used in the **VP-8x8TP**.

Table 4: Default Communication Parameters

RS-232			
Protocol 2000		Protocol 3000 (Default)	
Baud Rate:	9600	Baud Rate:	115,200
Data Bits:	8	Data Bits:	8
Stop Bits:	1	Stop Bits:	1
Parity:	None	Parity:	None
Command Format:	HEX	Command Format:	ASCII
Example (Output 1 to Input 1):	0x01, 0x81, 0x81, 0x81	Example (Output 1 to Input 1):	#AV 1>1<CR>
Switching Protocol			
P2000 -> P3000		P3000 -> P2000	
Command:	0x38, 0x80, 0x83, 0x81	Command:	#P2000<CR>

¹ Specifications are subject to change without notice

² P/N: C-A35M/IRR-50

Default EDID

Front Panel:	Press and hold Output 1 and Output 3 simultaneously	Front Panel:	Press and hold Output 1 and Output 2 simultaneously
Ethernet Factory Default Values			
IP Address: 192.168.1.39 Mask: 255.255.255.0 Gateway: 192.168.1.1		Power cycle the unit while pressing the Factory Reset button, located on the rear panel of the unit.	
TCP Port #: 5000			
UDP Port #: 50000			

14 Default EDID

The default EDID is stored in all inputs.

Monitor

Model name	VP-8X8TP
Manufacturer	KRM
Plug and Play, ID	KRM0808
Serial number	2
Manufacture date	2009, ISO week 10

ED D revision	1.3
Input signal type	Analog 0.700, 0.000 (0.7 Vp-p)
Sync input support	Separate, Composite, Sync-on-green
Display type	RGB color
Screen size	360 x 290 mm (18.2 in)
Power management	Standby, Suspend, Active off/Sleep
Extension blocs	None
DDC/CI	Not supported

Color characteristics

Default color space	sRGB
Display gamma	2.0
Red chromaticity	Rx 0.611 - Ry 0.329
Green chromaticity	Gx 0.312 - Gy 0.559
Blue chromaticity	Bx 0.148 - By 0.131
White point (default)	Wx 0.320 - Wy 0.336
Additional descriptors	None

Timing characteristics

Range limits	Not available
GTF standard	Not supported
Additional descriptors	None
Preferred timing	Yes
Native/preferred timing	1024x768p at 60Hz (4:3)
Modeline	"1024x768" 65 000 1024 1048 1184 1344 768 771 777 806 -hsync -vsync
Detailed timing #1	1280x800p at 60Hz (1:1)
Modeline	"1280x800" 71 000 1280 1328 1360 1440 800 803 809 823 +hsync -vsync

Standard timings supported

640 x 480p at 60Hz
640 x 480p at 67Hz
640 x 480p at 72Hz

640 x 480p at 75Hz
 800 x 600p at 56Hz
 800 x 600p at 60Hz
 800 x 600p at 72Hz
 800 x 600p at 75Hz
 1024 x 768p at 60Hz
 1024 x 768p at 70Hz
 1024 x 768p at 75Hz
 1280 x 1024p at 75Hz
 1280 x 1024p at 60Hz
 1280 x 960p at 60Hz
 1400 x 1050p at 60Hz
 1440 x 900p at 60Hz
 1600 x 1200p at 60Hz

Report information

Date generated 11/15/2010
 Software revision 2.43.0.822
 Operating system 5.1.2600.2.Service Pack 3

Raw data

00,FF,FF,FF,FF,FF,FF,FF,00,2E,4D,08,08,02,00,00,00,0A,13,01,03,6E,24,1D,64,EE,9C,20,9C,54,4F,8F,26,
 21,52,56,3F,CF,00,81,80,81,40,90,40,95,00,A9,40,D1,00,D1,C0,01,01,64,19,00,40,41,00,26,30,18,88,
 36,00,30,E4,10,00,00,18,BC,1B,00,A0,50,20,17,30,30,20,36,00,20,20,00,00,00,1A,00,00,00,FC,00,5E,
 50,2D,38,58,38,54,50,0A,20,20,20,20,00,00,00,10,00,56,50,2D,38,58,38,54,50,20,0A,20,20,20,00,4A

Table 5 and Table 6 list the ASCII codes that switch an input to an output for a single **VP-8x8TP** machine.

Table 5: VP-8x8TP Video Signal Codes

	OUT 1	OUT 2	OUT 3	OUT 4	OUT 5	OUT 6	OUT 7	OUT 8
IN 1	#V 1>1 <input type="checkbox"/>	#V 1>2 <input type="checkbox"/>	#V 1>3 <input type="checkbox"/>	#V 1>4 <input type="checkbox"/>	#V 1>5 <input type="checkbox"/>	#V 1>6 <input type="checkbox"/>	#V 1>7 <input type="checkbox"/>	#V 1>8 <input type="checkbox"/>
IN 2	#V 2>1 <input type="checkbox"/>	#V 2>2 <input type="checkbox"/>	#V 2>3 <input type="checkbox"/>	#V 2>4 <input type="checkbox"/>	#V 2>5 <input type="checkbox"/>	#V 2>6 <input type="checkbox"/>	#V 2>7 <input type="checkbox"/>	#V 2>8 <input type="checkbox"/>
IN 3	#V 3>1 <input type="checkbox"/>	#V 3>2 <input type="checkbox"/>	#V 3>3 <input type="checkbox"/>	#V 3>4 <input type="checkbox"/>	#V 3>5 <input type="checkbox"/>	#V 3>6 <input type="checkbox"/>	#V 3>7 <input type="checkbox"/>	#V 3>8 <input type="checkbox"/>
IN 4	#V 4>1 <input type="checkbox"/>	#V 4>2 <input type="checkbox"/>	#V 4>3 <input type="checkbox"/>	#V 4>4 <input type="checkbox"/>	#V 4>5 <input type="checkbox"/>	#V 4>6 <input type="checkbox"/>	#V 4>7 <input type="checkbox"/>	#V 4>8 <input type="checkbox"/>
IN 5	#V 5>1 <input type="checkbox"/>	#V 5>2 <input type="checkbox"/>	#V 5>3 <input type="checkbox"/>	#V 5>4 <input type="checkbox"/>	#V 5>5 <input type="checkbox"/>	#V 5>6 <input type="checkbox"/>	#V 5>7 <input type="checkbox"/>	#V 5>8 <input type="checkbox"/>
IN 6	#V 6>1 <input type="checkbox"/>	#V 6>2 <input type="checkbox"/>	#V 6>3 <input type="checkbox"/>	#V 6>4 <input type="checkbox"/>	#V 6>5 <input type="checkbox"/>	#V 6>6 <input type="checkbox"/>	#V 6>7 <input type="checkbox"/>	#V 6>8 <input type="checkbox"/>
IN 7	#V 7>1 <input type="checkbox"/>	#V 7>2 <input type="checkbox"/>	#V 7>3 <input type="checkbox"/>	#V 7>4 <input type="checkbox"/>	#V 7>5 <input type="checkbox"/>	#V 7>6 <input type="checkbox"/>	#V 7>7 <input type="checkbox"/>	#V 7>8 <input type="checkbox"/>
IN 8	#V 8>1 <input type="checkbox"/>	#V 8>2 <input type="checkbox"/>	#V 8>3 <input type="checkbox"/>	#V 8>4 <input type="checkbox"/>	#V 8>5 <input type="checkbox"/>	#V 8>6 <input type="checkbox"/>	#V 8>7 <input type="checkbox"/>	#V 8>8 <input type="checkbox"/>

Table 6: VP-8x8TP Audio Signal Codes

	OUT 1	OUT 2	OUT 3	OUT 4	OUT 5	OUT 6	OUT 7	OUT 8
IN 1	#A 1>1 <input type="checkbox"/>	#A 1>2 <input type="checkbox"/>	#A 1>3 <input type="checkbox"/>	#A 1>4 <input type="checkbox"/>	#A 1>5 <input type="checkbox"/>	#A 1>6 <input type="checkbox"/>	#A 1>7 <input type="checkbox"/>	#A 1>8 <input type="checkbox"/>
IN 2	#A 2>1 <input type="checkbox"/>	#A 2>2 <input type="checkbox"/>	#A 2>3 <input type="checkbox"/>	#A 2>4 <input type="checkbox"/>	#A 2>5 <input type="checkbox"/>	#A 2>6 <input type="checkbox"/>	#A 2>7 <input type="checkbox"/>	#A 2>8 <input type="checkbox"/>
IN 3	#A 3>1 <input type="checkbox"/>	#A 3>2 <input type="checkbox"/>	#A 3>3 <input type="checkbox"/>	#A 3>4 <input type="checkbox"/>	#A 3>5 <input type="checkbox"/>	#A 3>6 <input type="checkbox"/>	#A 3>7 <input type="checkbox"/>	#A 3>8 <input type="checkbox"/>
IN 4	#A 4>1 <input type="checkbox"/>	#A 4>2 <input type="checkbox"/>	#A 4>3 <input type="checkbox"/>	#A 4>4 <input type="checkbox"/>	#A 4>5 <input type="checkbox"/>	#A 4>6 <input type="checkbox"/>	#A 4>7 <input type="checkbox"/>	#A 4>8 <input type="checkbox"/>
IN 5	#A 5>1 <input type="checkbox"/>	#A 5>2 <input type="checkbox"/>	#A 5>3 <input type="checkbox"/>	#A 5>4 <input type="checkbox"/>	#A 5>5 <input type="checkbox"/>	#A 5>6 <input type="checkbox"/>	#A 5>7 <input type="checkbox"/>	#A 5>8 <input type="checkbox"/>
IN 6	#A 6>1 <input type="checkbox"/>	#A 6>2 <input type="checkbox"/>	#A 6>3 <input type="checkbox"/>	#A 6>4 <input type="checkbox"/>	#A 6>5 <input type="checkbox"/>	#A 6>6 <input type="checkbox"/>	#A 6>7 <input type="checkbox"/>	#A 6>8 <input type="checkbox"/>
IN 7	#A 7>1 <input type="checkbox"/>	#A 7>2 <input type="checkbox"/>	#A 7>3 <input type="checkbox"/>	#A 7>4 <input type="checkbox"/>	#A 7>5 <input type="checkbox"/>	#A 7>6 <input type="checkbox"/>	#A 7>7 <input type="checkbox"/>	#A 7>8 <input type="checkbox"/>

Tables of Hex Codes for Serial Communication (Protocol 2000)

	OUT 1	OUT 2	OUT 3	OUT 4	OUT 5	OUT 6	OUT 7	OUT 8
IN 8	#A 8>1 CR	#A 8>2 CR	#A 8>3 CR	#A 8>4 CR	#A 8>5 CR	#A 8>6 CR	#A 8>7 CR	#A 8>8 CR

Table 7 lists the codes that set the audio input gain.

Table 7: VP-8x8TP Audio Input Gain Codes

INPUT 1		INPUT 5		INPUT X*	Level [Rel]
#AUD-LVL 1,1, -100 CR		#AUD-LVL 1,5, -100 CR		#AUD-LVL 1,X, -100 CR	-100dB Mute
#AUD-LVL 1,1, -50 CR		#AUD-LVL 1,5, -50 CR		#AUD-LVL 1,X, -50 CR	-50dB
#AUD-LVL 1,1, 0 CR		#AUD-LVL 1,5, 0 CR		#AUD-LVL 1,X, 0 CR	0dB
#AUD-LVL 1,1, 20 CR		#AUD-LVL 1,5, 20 CR		#AUD-LVL 1,X, 20 CR	+20dB (Max)

* Where X is the input number from 1 - 8 For example, for channel 7 and relative level -50dB, #AUD-LVL 1,7, -50CR

15 Tables of Hex Codes for Serial Communication (Protocol 2000)

The hex codes listed in this section are used to set video channels for a single machine (set as Machine 1) connected via either RS-232 or Ethernet. Similar hex codes are used when the **VP-8x8TP** is connected via RS-485 and the machine is set to number 2.

Table 8 lists the Hex codes for switching video channels.

Table 8: VP-8x8TP Hex Codes for Switching Video Channels

Switching Video Channels								
	OUT 1	OUT 2	OUT 3	OUT 4	OUT 5	OUT 6	OUT 7	OUT 8
IN 1	01 81 81 81	01 81 82 81	01 81 83 81	01 81 84 81	01 81 85 81	01 81 86 81	01 81 87 81	01 81 88 81
IN 2	01 82 81 81	01 82 82 81	01 82 83 81	01 82 84 81	01 82 85 81	01 82 86 81	01 82 87 81	01 82 88 81
IN 3	01 83 81 81	01 83 82 81	01 83 83 81	01 83 84 81	01 83 85 81	01 83 86 81	01 83 87 81	01 83 88 81
IN 4	01 84 81 81	01 84 82 81	01 84 83 81	01 84 84 81	01 84 85 81	01 84 86 81	01 84 87 81	01 84 88 81
IN 5	01 85 81 81	01 85 82 81	01 85 83 81	01 85 84 81	01 85 85 81	01 85 86 81	01 85 87 81	01 85 88 81
IN 6	01 86 81 81	01 86 82 81	01 86 83 81	01 86 84 81	01 86 85 81	01 86 86 81	01 86 87 81	01 86 88 81
IN 7	01 87 81 81	01 87 82 81	01 87 83 81	01 87 84 81	01 87 85 81	01 87 86 81	01 87 87 81	01 87 88 81
IN 8	01 88 81 81	01 88 82 81	01 88 83 81	01 88 84 81	01 88 85 81	01 88 86 81	01 88 87 81	01 88 88 81

Table 9 lists the Hex codes for switching audio channels.

Table 9: VP-8x8TP Hex Codes for Switching Audio Channels

Switching Audio Channels								
	OUT 1	OUT 2	OUT 3	OUT 4	OUT 5	OUT 6	OUT 7	OUT 8
IN 1	02 81 81 81	02 81 82 81	02 81 83 81	02 81 84 81	02 81 85 81	02 81 86 81	02 81 87 81	02 81 88 81
IN 2	02 82 81 81	02 82 82 81	02 82 83 81	02 82 84 81	02 82 85 81	02 82 86 81	02 82 87 81	02 82 88 81
IN 3	02 83 81 81	02 83 82 81	02 83 83 81	02 83 84 81	02 83 85 81	02 83 86 81	02 83 87 81	02 83 88 81
IN 4	02 84 81 81	02 84 82 81	02 84 83 81	02 84 84 81	02 84 85 81	02 84 86 81	02 84 87 81	02 84 88 81
IN 5	02 85 81 81	02 85 82 81	02 85 83 81	02 85 84 81	02 85 85 81	02 85 86 81	02 85 87 81	02 85 88 81
IN 6	02 86 81 81	02 86 82 81	02 86 83 81	02 86 84 81	02 86 85 81	02 86 86 81	02 86 87 81	02 86 88 81
IN 7	02 87 81 81	02 87 82 81	02 87 83 81	02 87 84 81	02 87 85 81	02 87 86 81	02 87 87 81	02 87 88 81
IN 8	02 88 81 81	02 88 82 81	02 88 83 81	02 88 84 81	02 88 85 81	02 88 86 81	02 88 87 81	02 88 88 81

Table 10 lists the Hex codes for increasing or decreasing the audio input gain.

Table 10: VP-8x8TP Hex Codes for Increasing/Decreasing the Audio Input Gain

	IN 1	IN 2	IN 3	IN 4	IN 5	IN 6	IN 7	IN 8
Increase	18 81 86 81	18 82 86 81	18 83 86 81	18 84 86 81	18 85 86 81	18 86 86 81	18 87 86 81	18 88 86 81
Decrease	18 81 87 81	18 82 87 81	18 83 87 81	18 84 87 81	18 85 87 81	18 86 87 81	18 87 87 81	18 88 87 81

Table 11 lists the Hex codes for setting the audio input gain. Before sending the any of the codes in Table 11, the command **2A 86 80 81** must be sent.

Table 11: VP-8x8TP Hex Codes for Setting the Audio Input Gain

IN 1	IN 2	IN 3	IN 4	IN 5	IN 6	IN 7	IN 8	Level [Rel]
16 81 80 81	16 82 80 81	16 83 80 81	16 84 80 81	16 85 80 81	16 86 80 81	16 87 80 81	16 88 80 81	Mute
⋮	⋮	⋮	⋮	⋮	⋮	⋮	⋮	
16 81 87* 81	16 82 87* 81	16 83 87* 81	16 84 87* 81	16 85 87* 81	16 86 87* 81	16 87 87* 81	16 88 87* 81	-100dB Mute
⋮	⋮	⋮	⋮	⋮	⋮	⋮	⋮	
16 81 B9 81	16 82 B9 81	16 83 B9 81	16 84 B9 81	16 85 B9 81	16 86 B9 81	16 87 B9 81	16 88 B9 81	-50dB
⋮	⋮	⋮	⋮	⋮	⋮	⋮	⋮	
16 81 EB 81	16 82 EB 81	16 83 EB 81	16 84 EB 81	16 85 EB 81	16 86 EB 81	16 87 EB 81	16 88 EB 81	0dB
⋮	⋮	⋮	⋮	⋮	⋮	⋮	⋮	
16 81 FF 81	16 82 FF 81	16 83 FF 81	16 84 FF 81	16 85 FF 81	16 86 FF 81	16 87 FF 81	16 88 FF 81	+20dB (Max)

* BYTE 3 = 0x80 + Gain Value (0x00-0x7F)

16 Kramer Protocol

You can download our user-friendly *Software for Calculating Hex Codes for Protocol 2000*¹ from the technical support section on our Web site at <http://www.kramerelectronics.com>.

Section 16.1 describes how to switch between Protocol 3000 and Protocol 2000. Section 16.2 defines Protocol 3000 and Section 16.3 defines Protocol 2000.

By default, the **VP-8x8TP** is set to Kramer’s Protocol 3000, but it is also compatible with Protocol 2000.

16.1 Switching Protocols

You can switch protocols either via the front panel buttons (see Section 16.1.1) or by sending protocol commands (see Section 16.1.2).

16.1.1 Switching Protocols via the Front Panel Buttons

To switch from Protocol 3000 to Protocol 2000, press and hold¹ the OUT 1 and OUT 2 buttons for a few seconds.

To switch from Protocol 2000 to Protocol 3000, press and hold the OUT 1 and OUT 3 buttons for a few seconds.

¹ Not as part of a switching operation

16.1.2 Switching Protocols via Protocol Commands

To switch from Protocol 3000 to Protocol 2000, send the following command:

- #P2000<CR>

To switch from Protocol 2000 to Protocol 3000, send the following command:

- 0x38, 0x80, 0x83, 0x81

The Windows®-based Kramer control software¹ operates with Protocol 2000. If the **VP-8x8TP** is set to Protocol 3000, it is automatically switched to Protocol 2000.

16.2 Kramer Protocol 3000

This RS-232/RS-485 communication protocol lets you control the machine from any standard terminal software (for example, Windows® HyperTerminal) with default settings of 115200 baud data rate, no parity, 8 data bits, and 1 stop bit.

16.2.1 Protocol 3000 Syntax

Host message format:

Start	Address (optional)	Body	Delimiter
#	<i>Destination_id@</i>	message	CR

Simple command (commands string with only one command without addressing):

start	body	delimiter
#	Command SP Parameter_1,Parameter_2,...	CR

Commands string (formal syntax with commands concatenation and addressing):

Address@ **Command_1** *Parameter1_1,Parameter1_2,...* | **Command_2** *Parameter2_1,Parameter2_2,...* | **Command_3** *Parameter3_1,Parameter3_2,...* | ... **CR**

Device message format:

Start	Address (optional)	Body	Delimiter
~	<i>Sender_id@</i>	message	CR LF

Device long response (**Echoing command**):

Start	Address (optional)	Body	Delimiter
~	<i>Sender_id@</i>	command SP [<i>param1 ,param2 ...</i>] result	CR LF

CR = Carriage return (ASCII 13 = 0x0D)

LF = Line feed (ASCII 10 = 0x0A)

SP = Space (ASCII 32 = 0x20)

16.2.2 Command Parts Details

Command:

Sequence of ASCII letters ('A'-Z', 'a'-z' and '_')

Command will separate from parameters with at least single space

Parameters:

Sequence of Alfa-Numeric ASCII chars ('0'-9','A'-Z','a'-z' and some special chars for specific commands), parameters will be separated by commas

Message string:

Every command must to be entered as part of message string that begin with **message starting char** and end with **message closing char**, note that string can contain more then one command separated by pipe ("|") char

Message starting char:

'#' for host command/query

'~' for machine response

Device address (Optional, for Knet):

Knet Device ID follow by '@' char

Query sign = '?', will follow after some commands to define query request

Message closing char =

Host messages - Carriage Return (ASCII 13), will be referred to by **CR** in this document

Machine messages - Carriage Return (ASCII 13) + Line-Feed (ASCII 10), will be referred to by **CRLF**

Spaces between parameters or command parts will be ignored

Commands chain separator char:

When **message string** contains more than one command, commands will be separated by pipe ("|")

Commands entering:

If terminal software used to connect over serial \ ethernet \ USB port, that possible to directly enter all commands characters (**CR**) will be entered by Enter key, that key send also **LF**, but this char will be ignored by commands parser)

Sending commands from some controllers (like Crestron) require coding some characters in special form (like \X##) Anyway, there is a way to enter all ASCII characters, so it is possible to send all commands also from controller (Similar way can use for URL \ Telnet support that maybe will be added in future)

Commands forms:

Some commands have short name syntax beside the full name to allow faster typing, response is always in long syntax

Commands chaining:

It is possible to enter multiple commands in same string by '|' char (pipe)

In this case the **message starting char** and the **message closing char** will be entered just one time, in the string beginning and at the end

All the commands in string will not execute until the closing char will be entered

Separate response will be sent for every command in the chain

Input string max length:

64 characters

Backward support:

Design note: Transparent support for Protocol 2000 will be implemented by switch Protocol command from Protocol 3000 to Protocol 2000, in Protocol 2000 there is already such a command to switch Protocol to ASCII Protocol (#56 : H38 H80 H83 H81)

Table 12: Instruction Codes for Protocol 3000

Help commands		
Command	Syntax	Response
Protocol Handshaking	#CR	~OKCRLF

Device initiated messages	
Command	Syntax
Start message	Kramer Electronics LTD. , Device Model Version Software Version

Kramer Protocol

Switcher actions	
Audio-video channel has switched (AFV mode)	AV IN>OUT
Video channel has switched (Breakaway mode)	VID IN>OUT
Audio channel has switched (Breakaway mode)	AUD IN>OUT

Result codes (errors)	
	Syntax
No error. Command running succeeded	COMMAND PARAMETERS OK
Protocol Errors	
Syntax Error	ERR001
Command not available for his device	ERR002
Parameter is out of range	ERR003
Unauthorized access (running command without the matching login).	ERR004

Basic routing commands		
Command	Syntax	Response
Switch audio & video	AV IN>OUT , IN>OUT , ...	AV IN>OUT IN>OUT ... RESULT
Switch video only	VID IN>OUT , IN>OUT , ... Short form: V IN>OUT , IN>OUT , ...	VID IN>OUT IN>OUT ... RESULT
Note: When AFV mode is active, this command will switch also audio. If audio is breakaway – device display mode will change to show audio connections status.		
Switch audio only	AUD IN>OUT , IN>OUT , ... Short form: A IN>OUT , IN>OUT , ...	AUD IN>OUT IN>OUT ... RESULT
Note: When AFV mode is active, this command will switch also video.		
Read video connection	VID? OUT Short form: V? OUT VID? *	VID IN>OUT VID IN>1 IN>2 , ...
Read audio connection	AUD? OUT Short form: A? OUT AUD? *	AUD IN>OUT AUD IN>1 , IN>2 , ...
Parameters Description: IN = Input number or '0' to disconnect output. '>' = Connection character between in and out parameters. OUT = Output number or '*' for all outputs.		

Examples:

Switch Video and Audio input 3 to output 7	#AV 3>7 CR	~AV 3>7 OK CRLF
Switch Video input 2 to output 4	#V 2>4 CR	~VID 2>4 OK CRLF
Switch Video input 4 to output 2 in machine number 6	#6@VID 4>2 CR	~6@VID 4>2 OK CRLF
Disconnect Video and Audio Output 4	#AV 0>4 CR	~AV 0>4 OK CRLF
Switch Video Input 3 to All Outputs	#V 3>* CR	~VID 3>* OK CRLF

Kramer Protocol

Chaining Multiple commands*	<p>#AV 1>* V 3>4, 2>2, 82>1, 0>2 V 82>3 A 0>1 V? * CR</p> <p>First switch all Audio and video outputs from input 1, Then switch video input 3 to output 4, video input 2 to output 2, video input and disconnect video output 2.</p> <p>Then switch audio input 3 to output 2, Then disconnect audio output 1. Then get status of all links (assume this is 4x4 matrix). Commands processing start after entering CR, response will sent for each command after processing it.</p>	<p>~AV 1>* OK CRLF</p> <p>~VID 1>2, 3>4 OK CRLF</p> <p>~VID 82>3 ERR### CRLF</p> <p>~AUD 0>1 OK CRLF</p> <p>~V 1>1, 0>2, 1>3, 3>4 CRLF</p>
-----------------------------	--	--

Signal Status commands		
Command	Syntax	Response
Change signal status	-----	SIGNAL [INPUT] [STATUS]
Get signal status	SIGNAL? [INPUT]	SIGNAL [INPUT] [STATUS]

Parameters Description:
[NPUT] = Input number, '*' for all.
[STATUS] = Signal state: "0" or "off" for not existent signal. "1" or "on" for existent signal.

Preset commands		
Command	Syntax	Response
Store current connections to preset	PRST-STO [PRESET] Short form: PSTO [PRESET]	PRST-STO [PRESET] [RESULT]
Recall saved preset	PRST-RCL [PRESET] Short form: PRCL [PRESET]	PRST-RCL [PRESET] [RESULT]
Delete saved preset	PRST-DEL [PRESET] Short form: PDEL [PRESET]	PRST-DEL [PRESET] [RESULT]
Read video connections from saved preset	PRST-VID? [PRESET] [OUT] Short form: PVID? [PRESET] [OUT] PRST-VID? [PRESET] , *	PRST-VID [PRESET] , [IN] [OUT] PRST-VID [PRESET] , [IN] >1, [IN] >2, ...
Read audio connections from saved preset	PRST-AUD? [PRESET] [OUT] Short form: PAUD? [PRESET] [OUT] PRST-AUD? [PRESET] , *	PRST-AUD [PRESET] , [IN] [OUT] PRST-AUD [PRESET] , [IN] >1, [IN] >2, ...
Read saved presets list	PRST-LST? Short form: PLST?	PRST-LST [PRESET] , [PRESET] , ...
Parameters Description: [PRESET] = Preset number. [OUT] = Output in preset to show for, '*' for all.		

Kramer Protocol

Examples		
Store current Audio & Video connections to preset 5	#PRST-STR 5 CR	~PRST-STR 5 OK CRLF
Recall Audio & Video connections from preset 3	#PRCL 3 CR	~PRST-RCL 3 OK CRLF
Show source of video output 2 from preset 3	#PRST-VID? 3,2 CR	~PRST-VID 3: 4>2 CRLF

Operation commands		
Command	Syntax	Response
Lock front panel	LOCK-FP <u>LOCK-MODE</u> Short form: LCK <u>LOCK-MODE</u>	LOCK-FP <u>LOCK-MODE</u> <u>RESULT</u>
Get front panel locking state	LOCK-FP?	LOCK-FP <u>LOCK-MODE</u>
Parameters Description: LOCK-MODE = Front panel locking state: "0" or "off" to unlock front panel buttons. "1" or "on" to lock front panel buttons.		
Restart device	RESET	RESET OK
Switch to Protocol 2000*	P2000	P2000 OK
* Protocol 2000 has command to switch back to ASCII Protocol (like Protocol 3000)		

Audio parameters commands		
Command	Syntax	Response
Set audio level in specific amplifier stage.	AUD-LVL <u>STAGE</u> <u>CHANNEL</u> <u>VOLUME</u> Short form: ADL <u>STAGE</u> <u>CHANNEL</u> <u>VOLUME</u>	AUD-LVL <u>STAGE</u> <u>CHANNEL</u> <u>VOLUME</u> <u>RESULT</u>
Read audio volume level	AUD-LVL? <u>STAGE</u> <u>CHANNEL</u> Short form: ADL? <u>STAGE</u>	AUD-LVL <u>STAGE</u> <u>CHANNEL</u> <u>VOLUME</u>

Parameters Description:
<p>STAGE = "In", "Out" or Numeric value (present audio processing stage). For example: "0" for Input level, "1" for Pre-Amplifier, "2" for Amplifier (Out) etc.</p> <p>CHANNEL = Input or Output #</p> <p>VOLUME = Audio parameter in Kramer units, precede minus sign for negative values. <div style="margin-left: 40px;"> ++ increase current value, -- decrease current value. </div> </p> <p>MUTE MODE = 1 – Mute 0 – Unmute</p>

Kramer Protocol

Machine info commands		
Command	Syntax	Response
* Time settings commands require admin authorization		
Read in/out count	INFO-IO?	INFO-IO: IN <code>[INPUTS_COUNT]</code> OUT <code>[OUTPUTS_COUNT]</code>
Read max presets count	INFO-PRST?	INFO-PRST: VID <code>[PRESET_VIDEO_COUNT]</code> AUD <code>[PRESET_AUDIO_COUNT]</code>
Reset configuration to factory default	FACTORY	FACTORY <code>[RESULT]</code>
Mute Audio	MUTE <code>[MUTE MODE]</code>	MUTE <code>[MUTE MODE]</code> <code>[RESULT]</code>

Identification commands		
Command	Syntax	Response
Protocol Handshaking	# <code>[CR]</code>	-OK <code>[CRLF]</code>
Read device model	MODEL?	MODEL <code>[MACHINE_MODEL]</code>
Read device serial number	SN?	SN <code>[SERIAL_NUMBER]</code>
Read device firmware version	VERSION?	VERSION <code>[MAJOR]</code> <code>[MINOR]</code> <code>[BUILD]</code> <code>[REVISION]</code>
Set machine name	NAME <code>[MACHINE_NAME]</code>	NAME <code>[MACHINE_NAME]</code> <code>[RESULT]</code>
Read machine name	NAME?	NAME <code>[MACHINE_NAME]</code>
Reset machine name to factory default*	NAME-RST	NAME-RST <code>[MACHINE_FACTORY_NAME]</code> <code>[RESULT]</code>
*Note: machine name not equal to model name. This name relevance for site viewer identification of specific machine or for network using (with DNS feature on). <code>[MACHINE_NAME]</code> = Up to 14 Alfa-Numeric chars. * Machine factory name = Model name + last 4 digits from serial number.		
Set machine id number	MACH-NUM <code>[MACHINE_NUMBER]</code>	MACH-NUM <code>[OLD_MACHINE_NUMBER]</code> <code>[NEW_MACHINE_NUMBER]</code> <code>[RESULT]</code>
* Response will send after machine number has been changed. So the replay with header will be: <code>[NEW_MACHINE_NUMBER]</code> @MACH-NUM <code>[OLD_MACHINE_NUMBER]</code> <code>[NEW_MACHINE_NUMBER]</code> OK		

Network settings commands		
Set IP Address	NET-IP <code>[IP_ADDRESS]</code> NTIP	NET-IP <code>[IP_ADDRESS]</code> <code>[RESULT]</code>
Read IP Address	NET-IP? NTIP?	NET-IP <code>[IP_ADDRESS]</code>
Read MAC Address	NET-MAC? NTMC	NET-MAC <code>[MAC_ADDRESS]</code>
Set subnet mask	NET-MASK <code>[SUBNET_MASK]</code> NTMSK	NET-MASK <code>[SUBNET_MASK]</code> <code>[RESULT]</code>
Read subnet mask	NET-MASK? NTMSK?	NET-MASK <code>[SUBNET_MASK]</code>

Network settings commands		
Set gateway address	NET-GATE <u>GATEWAY_ADDRESS</u> NTGT	NET-GATE <u>GATEWAY_ADDRESS</u> <u>RESULT</u>
Read subnet mask	NET-GATE? NTGT?	NET-GATE <u>GATEWAY_ADDRESS</u>
Set DHCP mode	NET-DHCP <u>DHCP_MODE</u> NTDH	NET-DHCP <u>DHCP_MODE</u> <u>RESULT</u>
Read subnet mask	NET-DHCP? NTDH?	NET-DHCP <u>DHCP_MODE</u>
DHCP_MODE = 0 – Don't use DHCP (Use IP set by factory or IP set command). 1 – Try to use DHCP, if unavailable use IP as above.		
Change protocol ethernet port	ETH-PORT <u>PROTOCOL</u> , <u>PORT</u> ETHP	ETH-PORT <u>PROTOCOL</u> <u>PORT</u> <u>RESULT</u>
Read protocol ethernet port	ETH-PORT? <u>PROTOCOL</u> ETHP?	ETH-PORT <u>PROTOCOL</u> , <u>PORT</u>
PROTOCOL = TCP / UDP (transport layer protocol) PORT = ethernet port to enter protocol 3000 commands. 1-65535 = User defined port 0 - reset port to factory default (50000 for UDP, 5000 for TCP)		

Advanced switching commands		
Command	Syntax	Response
Set audio follow video mode	AFV <u>AFV-MODE</u>	AFV <u>AFV-MODE</u> <u>RESULT</u>
Note: This command effect device front-panel mode and AUD\VID command.		
Read audio follow video mode	AFV?	AFV <u>AFV-MODE</u>

AFV-MODE = Front panel AFV mode
 "0" or "afv" to set front panel switching buttons in audio-follow-video state.
 "1" or "brk" to set front panel switching buttons in their previous state when audio.

16.3 Kramer Protocol 2000

This RS-232/RS-485 communication protocol uses four bytes of information as defined below. The default data rate is 9600 baud, with no parity, 8 data bits and 1 stop bit.

Table 13: Protocol Definitions

MSB		INSTRUCTION						LSB
DESTINATION		N5	N4	N3	N2	N1	N0	
0	D							
7	6	5	4	3	2	1	0	

1st byte

INPUT							
I6	I5	I4	I3	I2	I1	I0	
1	6	5	4	3	2	1	0
7	6	5	4	3	2	1	0

2nd byte

OUTPUT							
O6	O5	O4	O3	O2	O1	O0	
1	O6	O5	O4	O3	O2	O1	O0
7	6	5	4	3	2	1	0

3rd byte

MACHINE NUMBER							
OVR	X	M4	M3	M2	M1	M0	
1	OVR	X	M4	M3	M2	M1	M0
7	6	5	4	3	2	1	0

4th byte

1st BYTE: Bit 7 – Defined as 0
 D – “DESTINATION”: 0 - for sending information to the switchers (from the PC);
 1 - for sending to the PC (from the switcher)
 N5 N0 – “INSTRUCTION”

The function that is to be performed by the switcher(s) is defined by the INSTRUCTION (6 bits) Similarly, if a function is performed via the machine’s keyboard, then these bits are set with the INSTRUCTION NO , which was performed The instruction codes are defined according to the table below (INSTRUCTION NO is the value to be set for N5 N0)

2nd BYTE: Bit 7 – Defined as 1
 I6 I0 – “INPUT”

When switching (ie instruction codes 1 and 2), the INPUT (7 bits) is set as the input number which is to be switched Similarly, if switching is done via the machine’s front-panel, then these bits are set with the INPUT NUMBER which was switched For other operations, these bits are defined according to the table

3rd BYTE: Bit 7 – Defined as 1
 O6 O0 – “OUTPUT”

When switching (ie instruction codes 1 and 2), the OUTPUT (7 bits) is set as the output number which is to be switched Similarly, if switching is done via the machine’s front-panel, then these bits are set with the OUTPUT NUMBER which was switched For other operations, these bits are defined according to the table

4th BYTE: Bit 7 – Defined as 1
 Bit 5 – Don’t care
 OVR – Machine number override
 M4 M0 – MACHINE NUMBER

Used to address machines in a system via their machine numbers. When several machines are controlled from a single serial port, they are usually configured together with each machine having an individual machine number If the OVR bit is set, then all machine numbers will accept (implement) the command, and the addressed machine will reply

For a single machine controlled via the serial port, always set M4 M0 = 1, and make sure that the machine itself is configured as MACHINE NUMBER = 1

Table 14: Instruction Codes for Protocol 2000

Note: All values in the table are decimal, unless otherwise stated

INSTRUCTION		DEFINITION FOR SPECIFIC INSTRUCTION		NOTE
#	DESCRIPTION	INPUT	OUTPUT	
0	RESET VIDEO	0	0	1
1	SWITCH V DEO	Set equal to video input which is to be switched (0 = disconnect)	Set equal to video output which is to be switched (0 = to all the outputs)	2
2	SWITCH AUDIO	Set equal to audio input which is to be switched (0 = disconnect)	Set equal to audio output which is to be switched (0 = to all the outputs)	2
3	STORE V DEO STATUS	Set as SETUP #	0 - to store 1 - to delete	2, 3
4	RECALL VIDEO STATUS	Set as SETUP #	0	2, 3
5	REQUEST STATUS OF A V DEO OUTPUT	Set as SETUP #	Equal to output number whose status is reqd	4, 3
6	REQUEST STATUS OF AN AUDIO OUTPUT	Set as SETUP #	Equal to output number whose status is reqd	4, 3
8	BREAKAWAY SETTING	0	0 - audio-follow-video 1 - audio breakaway	2
11	REQUEST BREAKAWAY SETTING	Set as SETUP #	0 - Request audio breakaway setting	3, 4, 6
15	REQUEST WHETHER SETUP IS DEFINED / VAL D INPUT IS DETECTED	SETUP # or Input #	0 - for checking if setup is defined 1 - for checking if input is valid	8
16	ERROR / BUSY	For invalid / valid input (i.e. OUTPUT byte = 4 or OUTPUT byte = 5), this byte is set as the input #	0 - error 1 - invalid instruction 2 - out of range 3 - machine busy 4 - invalid input 5 - valid input 6 - RX buffer overflow	9, 25
22	SET AUDIO PARAMETER	Equal to input / output number whose parameter is to be set (0 = all)	Set as parameter value	2, 24
24	INCREASE / DECREASE AUDIO PARAMETER	Equal to input / output number whose parameter is to be increased / decreased (0 = all)	0 - increase output 1 - decrease output 2 - increase left output 3 - decrease left output 4 - increase right output 5 - decrease right output 6 - increase input 7 - decrease input 8 - increase left input 9 - decrease left input 10 - increase right input 11 - decrease right input	2
25	REQUEST AUDIO PARAMETER	Equal to input / output number whose parameter is requested	0	6, 24
30	LOCK FRONT PANEL	0 - Panel unlocked 1 - Panel locked	0	2
31	REQUEST WHETHER PANEL IS LOCKED	0	0	16

INSTRUCTION		DEFINITION FOR SPECIFIC INSTRUCTION		NOTE
#	DESCRIPTION	INPUT	OUTPUT	
42	AUDIO PARAMETER SETTINGS FOR INSTRUCTIONS 22, 24, 25	INPUT Bit: 10 - 0=input; 1=output 11 - Left 12 - Right	0 - Gain 1 - Bass 2 - Treble 3 - Midrange 4 - Mix On	24
56	CHANGE TO ASCII	0	Kramer protocol 3000	19
61	IDENTIFY MACHINE	1 - video machine name 2 - audio machine name 3 - video software version 4 - audio software version	0 - Request first 4 digits 1 - Request first suffix 2 - Request second suffix 3 - Request third suffix 10 - Request first prefix 11 - Request second prefix 12 - Request third prefix	13
62	DEFINE MACHINE	1 - number of inputs 2 - number of outputs 3 - number of setups	1 - for video 2 - for audio	14

NOTES on the above table:

NOTE 1 - When the master switcher is reset, (e.g. when it is turned on), the reset code is sent to the PC. If this code is sent to the switchers, it will reset according to the present power-down settings.

NOTE 2 - These are bi-directional definitions. That is, if the switcher receives the code, it will perform the instruction; and if the instruction is performed (due to a keystroke operation on the front panel), then these codes are sent. For example, if the HEX code

01 85 88 83

was sent from the PC, then the switcher (machine 3) will switch input 5 to output 8. If the user switched input 1 to output 7 via the front panel keypad, then the switcher will send HEX codes:

41 81 87 83

to the PC.

When the PC sends one of the commands in this group to the switcher, then, if the instruction is valid, the switcher replies by sending to the PC the same four bytes that it was sent (except for the first byte, where the DESTINATION bit is set high).

NOTE 3 - SETUP # 0 is the present setting. SETUP # 1 and higher are the settings saved in the switcher's memory, (i.e. those used for Store and Recall).

NOTE 4 - The reply to a "REQUEST" instruction is as follows: the same instruction and INPUT codes as were sent are returned, and the OUTPUT is assigned the value of the requested parameter. The replies to instructions 10 and 11 are as per the definitions in instructions 7 and 8 respectively. For example, if the present status of machine number 5 is breakaway setting, then the reply to the HEX code

0B 80 80 85

would be HEX codes

4B 80 81 85

NOTE 6 - If INPUT is set to 127 for these instructions, then, if the function is defined on this machine, it replies with OUTPUT=1. If the function is not defined, then the machine replies with OUTPUT=0, or with an error (invalid instruction code).

If the INPUT is set to 126 for these instructions, then, if possible, the machine will return the current setting of this function, even for the case that the function is not defined. For example, for a video switcher which always switches during the VIS of input #1, (and its VIS setting cannot be programmed otherwise), the reply to the HEX code

0A FE 80 81 (ie. request VIS setting, with INPUT set as 126dec)

would be HEX codes

4A FE 81 81 (ie. VIS setting = 1, which is defined as VIS from input #1)

NOTE 8 - The reply is as in TYPE 3 above, except that here the OUTPUT is assigned with the value 0 if the setup is not defined / no valid input is detected; or 1 if it is defined / valid input is detected.

NOTE 9 - An error code is returned to the PC if an invalid instruction code was sent to the switcher, or if a parameter associated with the instruction is out of range (e.g. trying to save to a setup greater than the highest one, or trying to switch an input or output greater than the highest one defined). This code is also returned to the PC if an RS-232 instruction is sent while the machine is being programmed via the front panel. Reception of this code by the switcher is not valid.

NOTE 10 - This code is reserved for internal use.

NOTE 13 - This is a request to identify the switcher/s in the system. If the OUTPUT is set as 0, and the INPUT is set as 1, 2, 5 or 7, the machine will send its name. The reply is the decimal value of the INPUT and OUTPUT. For example, for a 2216, the reply to the request to send the audio machine name would be (HEX codes):

7D 96 90 81 (i.e. 128dec+ 22dec for 2nd byte, and 128dec+ 16dec for 3rd byte)

If the request for identification is sent with the INPUT set as 3 or 4, the appropriate machine will send its software version number. Again, the reply would be the decimal value of the INPUT and OUTPUT - the INPUT representing the number in front of the decimal point, and the OUTPUT representing the number after it. For example, for version 3.5, the reply to the request to send the version number would be (HEX codes):

7D 83 85 81 (i.e. 128dec+ 3dec for 2nd byte, 128dec+ 5dec for 3rd byte)

If the OUTPUT is set as 1, then the ASCII coding of the lettering following the machine's name is sent. For example, for the VS-7588YC, the reply to the request to send the first suffix would be (HEX codes):

7D D9 C3 81 (i.e. 128dec+ ASCII for "Y"; 128dec+ ASCII for "C")

NOTE 14 - The number of inputs and outputs refers to the specific machine which is being addressed, not to the system. For example, if six 16X16 matrices are configured to make a 48X32 system (48 inputs, 32 outputs), the reply to the HEX code

3E 82 81 82 (i.e. request the number of outputs)

would be HEX codes

7E 82 90 82

i.e. 16 outputs

NOTE 16 - The reply to the "REQUEST WHETHER PANEL IS LOCKED" is as in NOTE 4 above, except that here the OUTPUT is assigned with the value 0 if the panel is unlocked, or 1 if it is locked.

NOTE 19 - After this instruction is sent, the unit will respond to the ASCII command set defined by the OUTPUT byte. The ASCII command to operate with the HEX command set must be sent in order to return to working with HEX codes.

NOTE 24 - Further information needed in instructions 21, 22, 25 and 26, is sent using instruction 42 - which is sent prior to the instruction. For example, to request the audio gain value of right input # 9, send hex codes

2A 84 80 81

and then send HEX codes

19 89 81 81

To set MIX mode, send hex codes

2A 81 84 81

and then send HEX codes

16

NOTE 25 - For units which detect the validity of the video inputs, Instruction 16 will be sent whenever the unit detects a change in the state of an input (in real-time).

For example, if input 3 is detected as invalid, the unit will send the HEX codes

10 83 84 81

If input 7 is detected as valid, then the unit will send HEX codes

10 87 85 81

LIMITED WARRANTY

Kramer Electronics (hereafter *Kramer*) warrants this product free from defects in material and workmanship under the following terms

HOW LONG IS THE WARRANTY

Labor and parts are warranted for seven years from the date of the first customer purchase

WHO IS PROTECTED?

Only the first purchase customer may enforce this warranty

WHAT IS COVERED AND WHAT IS NOT COVERED

Except as below, this warranty covers all defects in material or workmanship in this product. The following are not covered by the warranty:

- 1 Any product which is not distributed by Kramer, or which is not purchased from an authorized Kramer dealer. If you are uncertain as to whether a dealer is authorized, please contact Kramer at one of the agents listed in the Web site www.kramerelectronics.com
- 2 Any product, on which the serial number has been defaced, modified or removed, or on which the WARRANTY VOID IF TAMPERED sticker has been torn, reattached, removed or otherwise interfered with
- 3 Damage, deterioration or malfunction resulting from:
 - i) Accident, misuse, abuse, neglect, fire, water, lightning or other acts of nature
 - ii) Product modification, or failure to follow instructions supplied with the product
 - iii) Repair or attempted repair by anyone not authorized by Kramer
 - iv) Any shipment of the product (claims must be presented to the carrier)
 - v) Removal or installation of the product
 - vi) Any other cause, which does not relate to a product defect
 - vii) Cartons, equipment enclosures, cables or accessories used in conjunction with the product

WHAT WE WILL PAY FOR AND WHAT WE WILL NOT PAY FOR

We will pay labor and material expenses for covered items. We will not pay for the following:

- 1 Removal or installations charges
- 2 Costs of initial technical adjustments (set-up), including adjustment of user controls or programming. These costs are the responsibility of the Kramer dealer from whom the product was purchased
- 3 Shipping charges

HOW YOU CAN GET WARRANTY SERVICE

- 1 To obtain service on your product, you must take or ship it prepaid to any authorized Kramer service center
- 2 Whenever warranty service is required, the original dated invoice (or a copy) must be presented as proof of warranty coverage, and should be included in any shipment of the product. Please also include in any mailing a contact name, company, address, and a description of the problem(s)
- 3 For the name of the nearest Kramer authorized service center, consult your authorized dealer

LIMITATION OF IMPLIED WARRANTIES

All implied warranties, including warranties of merchantability and fitness for a particular purpose, are limited in duration to the length of this warranty

EXCLUSION OF DAMAGES

The liability of Kramer for any effective products is limited to the repair or replacement of the product at our option. Kramer shall not be liable for:

- 1 Damage to other property caused by defects in this product, damages based upon inconvenience, loss of use of the product, loss of time, commercial loss; or
- 2 Any other damages, whether incidental, consequential or otherwise. Some countries may not allow limitations on how long an implied warranty lasts and/or do not allow the exclusion or limitation of incidental or consequential damages, so the above limitations and exclusions may not apply to you

This warranty gives you specific legal rights, and you may also have other rights, which vary from place to place

NOTE: All products returned to Kramer for service must have prior approval. This may be obtained from your dealer

This equipment has been tested to determine compliance with the requirements of:

- EN-50081: "Electromagnetic compatibility (EMC);
generic emission standard
Part 1: Residential, commercial and light industry"
- EN-50082: "Electromagnetic compatibility (EMC) generic immunity standard
Part 1: Residential, commercial and light industry environment"
- CFR-47: FCC* Rules and Regulations:
Part 15: "Radio frequency devices
Subpart B Unintentional radiators"

CAUTION!

- ⊠ Servicing the machines can only be done by an authorized Kramer technician. Any user who makes changes or modifications to the unit without the expressed approval of the manufacturer will void user authority to operate the equipment
- ⊠ Use the supplied DC power supply to feed power to the machine
- ⊠ Please use recommended interconnection cables to connect the machine to other components
* FCC and CE approved using STP cable (for twisted pair products)



For the latest information on our products and a list of Kramer distributors, visit our Web site www.kramerelectronics.com where updates to this user manual may be found. We welcome your questions, comments and feedback.



Caution

Safety Warning:

Disconnect the unit from the power supply before opening/servicing.



Kramer Electronics, Ltd.

Web site: www.kramerelectronics.com

E-mail: info@kramereel.com

P/N: 2900-000591 REV 2