

KRAMER



USER MANUAL

MODEL:

VS-411UHD
UHD 4x1 Auto Switcher



Scan for full manual

VS-411UHD Quick Start Guide

This guide helps you install and use your VS-411UHD for the first time.

Go to www.kramerav.com/downloads/VS-411UHD to download the latest user manual and check if firmware upgrades are available.

Step 1: Check what's in the box

- VS-411UHD UHD 4x1 Auto Switcher
- 4 Rubber feet
- IR remote control transmitter with batteries
- 1 Power supply (5V DC)
- 1 Quick start guide

Step 2: Get to know your VS-411UHD

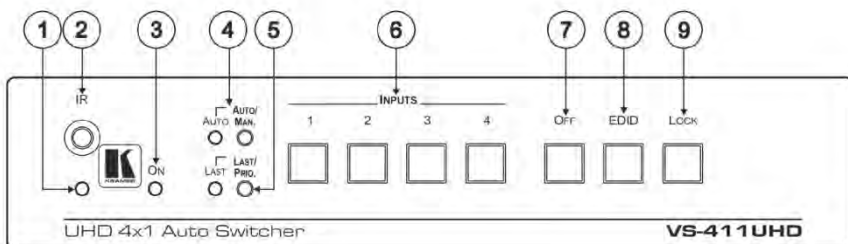

#	Feature	Function
1	IR LED	Lights when the unit accepts IR remote commands.
2	IR Receiver	Accepts IR remote commands.
3	ON LED	Lights when power is connected to the unit.
4	AUTO/MAN. Selector Button and LED	Toggle switch to select between automatic (LED on) or manual switching (LED off)
5	LAST/PRIO. Selector Button and LED	When in the AUTO mode, switch toggles to select switching to the last connected input (LED on) or the highest priority input (LED off).
6	INPUTS Selector Buttons	Press the INPUT button to select the input to switch to the output (from 1 to 4). Button LED indication: A selected input – the button illuminates. An active input that is not selected – the button is dim. A non-active button that is not selected – the button is dark.
7	OFF Button	Press to mute the video output (lit when muted).
8	EDID Button	Press to copy the EDID (button is illuminated).
9	LOCK Button	Press to lock the front panel buttons (button is illuminated).

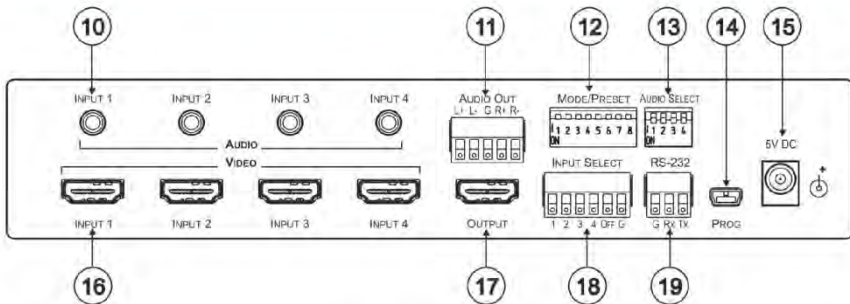

#	Feature	Function
10	AUDIO INPUT 3.5mm Mini Jack	Connect to the unbalanced stereo audio inputs (from 1 to 4).
11	AUDIO BALANCED OUT Terminal Block Connector	Connect the balanced stereo audio output to a balanced stereo audio acceptor.
12	MODE/PRESET DIP-switches	See Step 6.
13	AUDIO SELECT DIP-switches	Set audio embedding for inputs 1 to 4 (the switch number corresponds to the input number): <ul style="list-style-type: none"> Set down (ON) to always embed the analog audio. Set up (OFF) embeds analog audio only if the HDMI video does not have audio (DVI), see Step 6.
14	PROG mini-USB Port	Connects to a PC to upgrade the firmware.
15	5V DC	+5V DC connector for powering the unit.
16	INPUT HDMI Connectors	Connect to the HDMI sources (from 1 to 4).
17	OUTPUT HDMI Connector	Connect to the HDMI acceptor.
18	INPUT SELECT Terminal Block Connector	Connect to contact closure switches, see Step 6.
19	RS-232 Terminal Block Connector	Connect to the PC or the Remote Controller.

Step 3: Install the VS-411UHD

Attach the rubber feet and place on a table or mount the **VS-411UHD** in a rack (using an optional **RK-1** rack mount).

Step 4: Connect the inputs and outputs

Always switch OFF the power on each device before connecting it to your **VS-411UHD**. For best results, we recommend that you always use Kramer high-performance cables to connect AV equipment to the **VS-411UHD**.

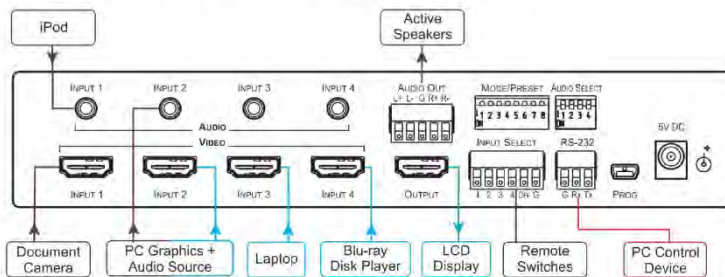

Step 5: Connect the power

Connect the 5V DC power adapter to the VS-411UHD and plug it into the mains electricity.

Safety instructions



Caution: There are no user-serviceable parts inside the unit.
Warning: Use only the Kramer Electronics power supply that is provided with the unit.
Warning: Disconnect the power and unplug the unit from the wall before installing.
 See www.kramerAV.com for updated safety information.

Step 6: Set the DIP-switches

All DIP-switches are off by default.

Set the Mode/Preset DIP-switches as shown in the following table:

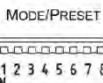

Set the Audio Select DIP-switches as shown in the lower table:



DIP	Function	Off (Up)	On (Down)
1	Audio EDID	Pass audio EDID of sink.	Limit to 2-CH LPCM (effective only after DIP 3 is set to on (down)).
2	Color EDID	Pass deep color parameter of sink.	Limit to RGB 8bpp (effective only after DIP 3 is set to on (down)).
3	Lock EDID	Pass EDID of sink.	Lock current display EDID and the current settings of DIPs 1 and 2 (the settings of DIPs 1 and 2 cannot be changed when DIP 3 is locked). This state also allows copying the default EDID or an EDID file to the inputs (if using EDID Designer, refresh after copying).
4	HDCP	Enable HDCP support . When Off, if the output supports HDCP, the input declares HDCP support. It then handles HDCP on the output and input actively. If the output does not support HDCP then the input does not support HDCP.	Disable HDCP support. When On, the device does not support HDCP on its input, even if HDCP is detected on the output.
5	ARC or Step-in for the 1st HDMI input	Step-in	ARC audio
6	Analog Output Audio From	Source	ARC audio
7	Output Off	Disable (to support audio only embedding).	Enable
8	Output Off Delay Settings	15sec default (configurable).	15min

Audio Select DIP-switches

DIP #	Function	Description	
		Off (Up)	On (Down)
1	Input 1 audio embedding	Embed analog audio only if the HDMI video does not have audio (DVI).	Always embed analog audio.
2	Input 2 audio embedding		
3	Input 3 audio embedding		
4	Input 4 audio embedding		

Step 7: Operation

Manual Switch Mode

In Manual switch mode, the **VS-411UHD** does not automatically switch to another channel even if an input signal is not detected on the manually selected input.

To select the Manual switch mode:

1. Press the **AUTO/MAN.** button. The Auto LED turns off.
2. Press an **INPUTS** button (1 to 4) to route this input to the HDMI output. The keys respond as follows:
Input LED bright: input selected.
Input LED dim: input active and not selected.
Input LED off: input is not active and not selected.

Auto Switch Mode

In Auto switch mode, the **VS-411UHD** automatically switches one of four HDMI inputs to a predefined or the last connected input whenever the currently active video signal is interrupted or whenever a higher-priority video signal is detected.

To select Auto switch mode:

1. Press the **AUTO/MAN.** button to turn the Auto LED on.
2. Press the **LAST/PRIO.** button to select an auto switch mode:
Last connected (LAST LED on) – The device always switches to a newly detected active video source. When the device is powered on, the output switches to the highest priority input.
Priority (LAST LED off) – The device always switches to the highest priority input source. First priority is Input 1 then 2, 3, and 4.

Manual Override Mode

Auto switch mode can be overridden by a manual command, such as pressing an input button or sending a control command. In such a case, the system switches to the manually selected source. If this manually selected source is not active, the system waits a set amount of time (10 seconds, default; can be changed using Protocol 3000 commands) and then switches back to auto mode. Manual override selection is not stored in non-volatile memory.

Step 8: Technical specifications

INPUTS:	4 HDMI connectors, 4 unbalanced stereo audio on 3.5mm mini jacks
OUTPUTS:	1 HDMI connector, 1 balanced stereo audio on 5-pin terminal block
PORTS:	1 RS-232 on a 3-pin terminal block, 1 mini USB for programming
COMPLIANCE WITH HDMI STANDARD:	HDMI 1.4, Deep Color, 3D, ARC, up to 7.1 uncompressed audio channels
MAX. DATA RATE:	8.91Gbps (2.97Gbps per graphic channel)
SUPPORTED RESOLUTIONS:	Up to 4K x 2K, 4K@60Hz (4:2:0)
CONTROLS:	Front panel buttons, contact closure, IR, RS-232 Protocol 3000
SOFTWARE SUPPORT:	Protocol 3000, EDID Designer, K-Upload
POWER CONSUMPTION:	5V DC, 500mA
OPERATING TEMPERATURE:	0° to +40°C (32° to 104°F)
STORAGE TEMPERATURE:	-40° to +70°C (-40° to 158°F)
HUMIDITY:	10% to 90% RHL non-condensing
DIMENSIONS:	21.5cm x 16.3cm x 4.4cm (8.4" x 6.4" x 7.2") W, D, H
WEIGHT:	0.89kg (1.96lbs) approx.
SHIPPING DIMENSIONS:	31.5cm x 21.2cm x 7.2cm (12.4" x 8.4" x 2.8") W, D, H
SHIPPING WEIGHT:	1.49kg (3.28lbs) approx.
INCLUDED ACCESSORIES:	Power adapter, IR remote control
OPTIONS:	RK-1 19" rack adapter

Contents

1	Introduction	1
2	Getting Started	2
2.1	Achieving the Best Performance	2
2.2	Safety Instructions	2
2.3	Recycling Kramer Products	3
3	Overview	4
3.1	Defining the VS-411UHD UHD 4x1 Auto Switcher	5
4	Connecting the VS-411UHD	7
4.1	Connecting a Serial Controller to the VS-411UHD via RS-232	8
4.2	Setting the DIP-Switches	9
5	Operating the VS-411UHD	10
5.1	Switching – Manual and Auto	10
5.2	Setting the Switching Speed	11
5.3	Muting the Output	12
5.4	Copying the EDID	12
5.5	Setting the 5V Output Time Delay	12
5.6	Setting HDCP Capability	12
5.7	Setting Audio Output	13
5.8	Using the Remote Control	14
5.9	Step-In Support	14
5.10	Using VCOM on USB	14
5.11	Upgrading the Firmware	14
6	Controlling the VS-411UHD	15
6.1	Using the Front Panel Buttons	15
6.2	Switching via the Terminal Block Connector	16
6.3	Using the RC-IR3 Remote Control Transmitter with the VS-411UHD	17
6.4	Connecting to the VS-411UHD via RS-232	17
6.5	Performing a Factory Reset	18
7	Technical Specifications	19
8	Supported Resolutions	20
9	Default Settings	21
9.1	Default Communication Settings	21
9.2	First Power On Default Settings	21
9.3	Default EDID	22
10	Protocol 3000	24
10.1	Understanding Protocol 3000	25
10.2	Kramer Protocol 3000 Syntax	27
10.3	Protocol 3000 Commands	28

Figures

Figure 1:	VS-411UHD 4x1 Auto Switcher	5
Figure 2:	Connecting the VS-411UHD UHD 4x1 Auto Switcher	8
Figure 3:	AUDIO SELECT DIP-Switches	9
Figure 4:	Connecting the Contact Closure Remote Control Pins	16
Figure 5:	RS-232 Pinout	17

1 Introduction

Welcome to Kramer Electronics! Since 1981, Kramer Electronics has been providing a world of unique, creative, and affordable solutions to the vast range of problems that confront video, audio, presentation, and broadcasting professionals on a daily basis. In recent years, we have redesigned and upgraded most of our line, making the best even better!

Our 1,000-plus different models now appear INPUT 14 groups that are clearly defined by function: GROUP 1: Distribution Amplifiers; GROUP 2: Switchers and Routers; GROUP 3: Control Systems; GROUP 4: Format/Standards Converters; GROUP 5: Range Extenders and Repeaters; GROUP 6: Specialty AV Products; GROUP 7: Scan Converters and Scalers; GROUP 8: Cables and Connectors; GROUP 9: Room Connectivity; GROUP 10: Accessories and Rack Adapters; GROUP 11: Sierra Video Products; GROUP 12: Digital Signage; GROUP 13: Audio; and GROUP 14: Collaboration.

Congratulations on purchasing your Kramer **VS-411UHD** UHD 4x1 Auto Switcher, which is ideal for the following typical applications:

- Mid- to small-sized meeting/conference rooms
- Educational lecture rooms
- Systems that require automatic HDMI routing
- Presentation and multimedia applications

2 Getting Started

We recommend that you:

- Unpack the equipment carefully and save the original box and packaging materials for possible future shipment
- Review the contents of this user manual



Go to www.kramerav.com/downloads/VS-411UHD to check for up-to-date user manuals, application programs, and to check if firmware upgrades are available (where appropriate).

2.1 Achieving the Best Performance

To achieve the best performance:

- For optimum range and performance, use the recommended Kramer cables available at www.kramerav.com/product/VS-411UHD
- Do not secure the cables in tight bundles or roll the slack into tight coils
- Avoid interference from neighbouring electrical appliances that may adversely influence signal quality
- Position your Kramer **VS-411UHD** away from moisture, excessive sunlight and dust



This equipment is to be used only inside a building. It may only be connected to other equipment that is installed inside a building.

2.2 Safety Instructions



Caution: There are no operator serviceable parts inside the unit

Warning: Use only the Kramer Electronics power supply that is provided with the unit

Warning: Disconnect the power and unplug the unit from the wall before installing

2.3 Recycling Kramer Products

The Waste Electrical and Electronic Equipment (WEEE) Directive 2002/96/EC aims to reduce the amount of WEEE sent for disposal to landfill or incineration by requiring it to be collected and recycled. To comply with the WEEE Directive, Kramer Electronics has made arrangements with the European Advanced Recycling Network (EARN) and will cover any costs of treatment, recycling and recovery of waste Kramer Electronics branded equipment on arrival at the EARN facility. For details of Kramer's recycling arrangements in your particular country go to our recycling pages at www.kramerav.com/support/recycling/.

3 Overview

The **VS-411UHD** is an automatic switcher for HDMI (up to 4K@60Hz (4:2:0)) and analog audio signals. The unit automatically switches one of four HDMI inputs to a predefined or the last connected input whenever the currently active video signal is interrupted or whenever a higher-priority video signal is detected. It also supports Kramer's Step-in over HDMI technology.

The unit can embed analog audio to an HDMI signal and can extract the audio from either an input HDMI signal or an output Audio Return Channel (ARC) HDMI signal. The **VS-411UHD** can output an analog audio source on the HDMI output even when an HDMI source is not connected and enters sleep mode when no input is detected.

The **VS-411UHD** features:

- Maximum data rate 8.91Gbps (2.97Gbps per graphic channel)
- Resolution support for up to 4K@60Hz (4:2:0) UHD
- Supports Kramer Step-In over HDMI technology
- HDTV compatible
- Active switching – selectable manual or fast auto switching according to last connected or preset priority
- HDMI 1.4, HDCP and DVI 1.0 compliant
- HDMI 1.4 support for Deep Color, 3D, ARC, up to 7.1 uncompressed audio channels
- HDMI 1 input supports CEC and ARC
- HDMI ARC de-embedding from output to balanced stereo audio line out, uncompressed
- Automatic video input detection and selection
- Auto-power off when no HDMI input for 10 seconds (selectable)
- HDCP on/off switching
- EDID configuration options

- Default EDID
- Contact closure for remote manual switching override
- Audio embedding/de-embedding
- Analog audio input per port
- A LOCK button to prevent tampering
- Firmware upgrade over RS-232, mini-USB
- Support for Protocol 3000, EDID Designer, K-Upload via RS-232
- Varied control options – front panel buttons, contact closure, IR, RS-232 Protocol 3000

3.1 Defining the VS-411UHD UHD 4x1 Auto Switcher

This section defines the **VS-411UHD**.

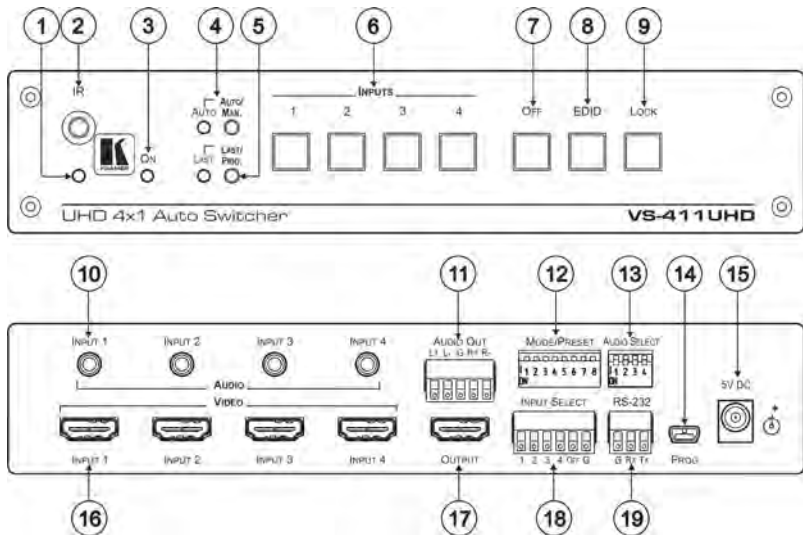

Figure 1: VS-411UHD 4x1 Auto Switcher

#	Feature	Function
1	IR LED	Lights yellow when the unit accepts IR remote commands.
2	IR Receiver	Accepts IR remote commands.
3	ON LED	Lights when power is connected to the unit.
4	AUTO/MAN Selector Button and LED	Toggle switch to select between automatic (LED on) or manual switching (LED off).
5	LAST/PRIO. Selector Button and LED	When in the AUTO mode, toggle switch to select switching to the last connected input (LED on) or the highest priority input (LED off).
6	INPUT Select Buttons	Press the INPUT button to select the input to switch to the output (from 1 to 4). Button LED indication: A selected input – the button illuminates. An active input that is not selected – the button is dim. A non-active input that is not selected – the button is dark.
7	OFF Button	Press to mute the video output (lit when muted).
8	EDID Button	Press to copy the EDID (button is lit), see Section 5.4.
9	LOCK Button	Press to lock the front panel buttons (button is lit).
10	AUDIO INPUT 3.5mm Mini Jack	Connect to the unbalanced stereo audio inputs (from 1 to 4).
11	BALANCED OUT Terminal Block Connector	Connect the balanced stereo audio output to a balanced stereo audio acceptor.
12	MODE/PRESET DIP-switches	See Section 4.2.1.
13	AUDIO SELECT DIP-switches	Set audio embedding for inputs 1 to 4 (the switch number corresponds to the input number): <ul style="list-style-type: none"> • Set down (ON) to always embed the analog audio. • Set up (OFF) embeds analog audio only if the HDMI video does not have audio (DVI), see Section 4.2.2.
14	PROG mini-USB Port	Connects to a PC to upgrade the firmware.
15	5V DC	+5V DC connector for powering the unit.
16	INPUT HDMI Connectors	Connect to the HDMI sources (from 1 to 4).
17	OUTPUT HDMI Connector	Connect to the HDMI acceptor.
18	INPUT SELECT Terminal Block	Connects to contact closure switches, see Section 6.2.
19	RS-232 Terminal Block Connector	Connect to the PC or the Remote Controller.

4 Connecting the VS-411UHD



Always switch off the power to each device before connecting it to your **VS-411UHD**. After connecting your **VS-411UHD**, connect its power and then switch on the power to each device.



You do not have to connect all the inputs and outputs, connect only those that are required.

To connect the **VS-411UHD** as illustrated in the example in [Figure 2](#):

1. Connect an HDMI source (for example, a laptop) to the INPUT 1 HDMI connector and connect an analog audio source (for example, an audio player) to the INPUT 1 3.5 mini-jack connector.
You can also connect a DVD player with a DVI connector, using a DVI-HDMI adapter to transfer video signals
2. Connect HDMI sources (examples: document camera, Blu-ray player, or PC) to the INPUT 2, 3, 4 HDMI connectors and connect audio inputs as required to the INPUT 2, 3, 4 3.5 mini-jack connectors.
3. Connect the OUT HDMI connector to the HDMI acceptor (for example, an LCD display).
4. Connect the AUDIO OUT terminal block connector to a balanced stereo audio acceptor (for example, active speakers).
5. Set the AUDIO SELECT DIP-switches (see [Section 5.1.2](#))
6. Set the MODE/PRESET DIP-switches (see [Section 5.1.2](#))
7. If required, connect a PC and/or controller to the RS-232 terminal block connector (see [Section 4.1](#)).
8. If required, connect the contact closure terminal block connectors (see [Section 6.2](#)).
9. Connect the 5V DC power adapter to the power socket and connect the adapter to the mains electricity (not shown in [Figure 2](#)).

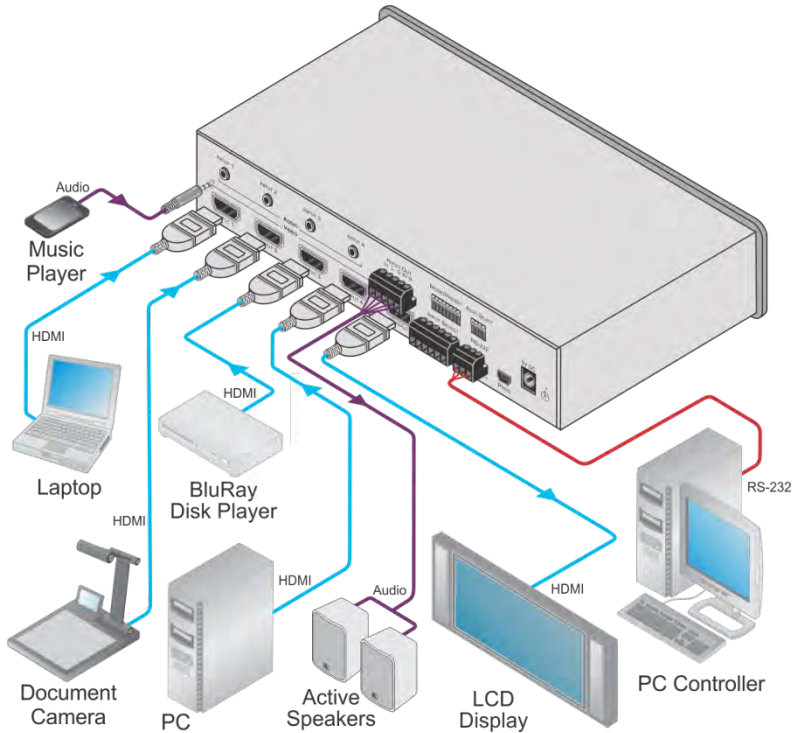

Figure 2: Connecting the VS-411UHD UHD 4x1 Auto Switcher

4.1 Connecting a Serial Controller to the VS-411UHD via RS-232

The **VS-411UHD** operates at two baud rates – 9600 (default) and 115,200 (see all communication parameters in [Section 9.1](#)).

To connect a serial controller to the VS-411UHD:

- From the RS-232 9-pin D-sub serial port on the serial controller connect:
 - Pin 2 to the TX pin on the **VS-411UHD** RS-232 terminal block
 - Pin 3 to the RX pin on the **VS-411UHD** RS-232 terminal block
 - Pin 5 to the GND pin on the **VS-411UHD** RS-232 terminal block

4.2 Setting the DIP-Switches

The DIP-switches dictate the behavior of the **VS-411UHD**. All DIP-switches are off by default.

4.2.1 Mode/Preset DIP-Switches

DIP	Function	Off (Up)	On (Down)
1	Audio EDID	Pass audio EDID of sink.	Limit to 2-CH LPCM (effective only after DIP 3 is set to on (down)).
2	Color EDID	Pass deep color parameter of sink.	Limit to RGB 8bpp (effective only after DIP 3 is set to on (down)).
3	Lock EDID	Pass EDID of sink.	Lock current display EDID and the current settings of DIPs 1 and 2 (the settings of DIPs 1 and 2 cannot be changed when DIP 3 is locked). This state also allows copying the default EDID or an EDID file to the inputs (if using EDID Designer, refresh after copying).
4	HDCP	Enable HDCP support. When Off, if the output supports HDCP, the input declares HDCP support. It then handles HDCP on the output and input actively. If the output does not support HDCP then the input does not support HDCP.	Disable HDCP support. When On, the device does not support HDCP on its input, even if HDCP is detected on the output.
5	ARC or Step-in for the 1st HDMI input	Step-in	ARC audio
6	Analog Output Audio From	Source	ARC audio
7	Output Off	Disable (to support audio only embedding).	Enable
8	Output Off Delay Settings	15sec default (configurable).	15min

4.2.2 Audio Select DIP-Switches

AUDIO SELECT



Figure 3: AUDIO SELECT DIP-Switches

DIP #	Function	Description	
		Off (Up)	On (Down)
1	Input 1 audio embedding	Embed analog audio only if the HDMI video does not have audio.	Always embed analog audio.
2	Input 2 audio embedding		
3	Input 3 audio embedding		
4	Input 4 audio embedding		

5 Operating the VS-411UHD

This section describes the **VS-411UHD** setup.

5.1 Switching – Manual and Auto

Switching can be performed automatically or manually using the device's keypad, remote control, or control commands. This section describes using the keypad buttons to select Auto or Manual switch modes. The same procedure can also be used for controlling switching via the remote control. For information about switching via control commands, see [Section 10.3](#).

5.1.1 The Manual Switching Mode

In the manual mode, the **VS-411UHD** acts as a regular switcher, switching the input video and audio signals to the output via the four front panel INPUT buttons.

To select the Manual switch mode:

1. Press the AUTO/MANUAL button to turn the AUTO LED off.
2. Press the INPUT1 to INPUT4 button to route this input to the HDMI output.

The keys respond as follows:

- Input LED bright: input active and selected
- Input LED dim: input active and not selected
- Input LED off: input is not active and not selected

5.1.2 Auto Switch Mode

In Auto switch mode, the **VS-411UHD** automatically switches one of four HDMI inputs to a predefined or the last connected input whenever the currently active video signal is interrupted or whenever a higher-priority video signal is detected.

To select Auto switch mode:

1. Press the AUTO/MAN. button to turn the AUTO LED on.
2. Press the LAST/PRIO. button to select an auto switch mode:
 - Last connected (LAST LED on) – The device always switches to a newly detected active video source. When the device is powered on, the output switches to the highest priority input
 - Priority (LAST LED off) – The device always switches to the highest priority input source. The default priority is Input 1 then Input 2.

5.1.3 Manual Override Mode

Auto switch mode can be overridden by a manual command, such as pressing an input button or sending a control command. In such a case, the system switches to the manually selected source. If this manually selected source is not active, the system waits a set amount of time (10 seconds, default) and then switches back to auto mode. Manual override selection is not stored in non-volatile memory.

5.2 Setting the Switching Speed

The **VS-411UHD** supports setting normal and fast (default) switching speeds.

To set switching speed modes:

1. Disconnect device power.
2. Press and hold one of the following buttons together with the OFF button:
 - INPUT 1 button – for setting fast switching speed mode.
 - INPUT 2 button – for setting normal switching speed mode.
3. Power the device on.
The device switching speed is modified.

5.3 Muting the Output

- Press the OFF button to mute the audio and video outputs

5.4 Copying the EDID

The EDID is a data structure transmitted by the display that enables the **VS-411UHD** to recognize the display connected to the output. The **VS-411UHD** acquires and stores the EDID to make reconnection to the display effortless.

When the device is first powered on, it has default EDID loaded. The device automatically reads and saves the first read EDID. Use DIP-switches 1-3 to set EDID functionality (see [Section 4.2](#)).

While copying EDID data, the input port's HPD function changes from Low to High which may affect the channel's auto-switching.



The device automatically recognizes EDID differences between input and output channels based on parts of the EDID data, including manufacturer, serial number, and first block check-sum information. EDID data is not copied if any difference is recognized.

Note: If a corrupted EDID is copied, the device loads the default EDID on all inputs.

5.5 Setting the 5V Output Time Delay

Use DIP-switch 8 to set the delay time. Off (Up) delays 15 seconds, On (Down) delays 15 minutes. A Protocol 3000 command can modify the delay time.

When there is no signal clock or 5V input on all inputs for the set delay, the device shuts down the 5V output.

5.6 Setting HDCP Capability

The **VS-411UHD** supports HDCP communication automatically, by default. When HDCP is detected in the input signal, it is enabled in the output signal. You can also disable HDCP support using DIP-switch 4 (see [Section 4.2](#)). Enabling or disabling HDCP support is universal for all inputs.

5.7 Setting Audio Output

The **VS-411UHD** enables customizing the audio output by embedding audio in HDMI, de-embedding HDMI ARC from output to the uncompressed balanced stereo audio line out, or routing the HDMI / analog inputs to the uncompressed balanced stereo audio line out.

5.7.1 Embedding Audio in HDMI

The **VS-411UHD** can output audio to the HDMI Out port from the original HDMI input or the Analog unbalanced 3.5mm audio input, by embedding it in the HDMI input signal. The **VS-411UHD** enables setting the audio output separately for each input using DIP-switches 5 and 6 (see [Section 4.2](#)).



An Input 1 analog audio signal can only be embedded in the Input 1 HDMI signal.

An Input 2 analog audio signal can only be embedded in the Input 2 HDMI signal.

5.7.2 Outputting Audio from ARC or Device Inputs

The **VS-411UHD** can output audio to the balanced stereo Audio Out terminal block from the following input sources:

- ARC – In this mode, the device does not enable embedding audio in the HDMI signal.
- HDMI inputs / Analog unbalanced 3.5mm audio inputs – In this mode, the balanced stereo Audio Out terminal block and the HDMI Out port both output audio. The Audio Out terminal block mutes the audio when the input audio signal is not LPCM.

Use DIP-switch 7 to set output to ARC / device inputs (see [Section 4.2](#)).



When de-embedding multichannel audio, the device outputs FL (front left) and FR (front right) channels only and cuts the rest of the audio channels.

5.8 Using the Remote Control

You can use the **RC-IR3** wireless remote control to control the **VS-411UHD** via the built-in IR receiver on the front panel. For more information, see www.kramerav.com/Product/RC-IR3.

5.9 Step-In Support

The **VS-411UHD** supports programmable step-in functionality when used in conjunction with compatible step-in devices, such as the **SID-X3N** and **DIP-31** (using an HDMI cable that supports HEC, the HDMI Ethernet Channel).

When ARC mode is enabled, Input 1 step-in mode is disabled. If you require step-in mode on Input 1, set the audio output to the device inputs (see [Section 5.7.2](#)).

5.10 Using VCOM on USB

USB can work as a port for virtual com (VCOM). Verify that the USB port on the PC that connects to the **VS-411UHD** is configured as a VCOM port. You may need to install a driver to do this. Use a tool such as Hercules or K-Config to use Protocol 3000 over USB. For more information on using the commands see [Section 10](#).

5.11 Upgrading the Firmware

The **VS-411UHD** can be upgraded via USB or RS-232.

For instructions on upgrading the firmware, see "*K-Upload Software User Guide*" (k.kramerav.com/support/download.asp?f=39700).

6 Controlling the VS-411UHD

The **VS-411UHD** can be controlled via:

- The front panel buttons (see [Section 6.1](#))
- Contact closure (see [Section 6.2](#))
- The RC-IR3 Remote control transmitter (see [Section 6.3](#))
- RS-232 port (see [Section 6.4](#))

6.1 Using the Front Panel Buttons

The **VS-411UHD** includes the following front panel buttons:

- The AUTO/MAN. button, toggling between the Auto and the manual mode (see [Section 5.1](#))
- The LAST/PRIO. button, toggling between set priorities or last connected modes (see [Section 5.1.2](#))
- Front Panel INPUT buttons (see [Section 3.1](#))
- The OFF button to mute the video output
- The EDID button to copy EDID (see [Section 5.4](#))
- The LOCK button to lock the front panel buttons

The front panel button LEDs behave as follows:

- Bright red: an active input signal is detected and selected
 - Dim red: that input is active, but not selected
 - Off: no signal is detected (or the signal is not active)
- If a non-active signal is selected, the display appears black

6.2 Switching via the Terminal Block Connector

The INPUT SELECT terminal block connector includes five input pins and a G pin for selecting an input:

- 1 – Switch to Input 1
- 2 – Switch to Input 2
- 3 – Switch to Input 3
- 4 – Switch to Input 4
- OFF – Mutes the HDMI output

For example, you may override (equivalent to pressing a different input button) the presently routed input by using the remote control contact closure. To do so, connect the appropriate input number (input 1, 2, 3 or 4) pin on the REMOTE terminal block connector to the G (Ground) pin, as Figure 4 illustrates.

To disconnect the inputs from the output, connect the OFF pin on the REMOTE terminal block connector to the G (Ground) pin, as Figure 4 illustrates.



When in the manual mode (AUTO front panel LED is off), you can switch an input to the output using the front panel INPUT SELECT button.

Note that unless the connection is permanent, the **VS-411UHD** reverts to an automatic switcher when the connection is removed.



DO NOT Connect more than one pin to the Ground pin at the same time.

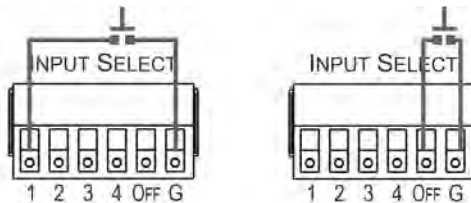

To select HDMI 1 (2, 3, 4), momentarily connect the INPUT SELECT 1 (2, 3, 4) pin to the G pin

To disconnect all the inputs from the output, momentarily connect the INPUT SELECT OFF pin to the G pin

Figure 4: Connecting the Contact Closure Remote Control Pins

6.3 Using the RC-IR3 Remote Control Transmitter with the VS-411UHD

You can control the **VS-411UHD** via the Kramer **RC-IR3** Remote Control Transmitter.

To switch an input to the output:

- Press key 1 (2, 3, 4) to switch INPUT 1 (2, 3, 4) to the output

To mute audio and video on the output:

- Press the OFF key to disconnect the output

The IR LED behaves as follows:

- When the device is powered on, the IR LED turns on for a short time and then turns off
- Before finding the sink, the LED is off
- After finding the sink, the LED is on
- When receiving information, the LED flashes

6.4 Connecting to the VS-411UHD via RS-232

Connect the RS-232 Terminal block connector on the product to the RS-232 9-pin D-sub port on your PC/controlled device to control the **VS-411UHD**, as shown in [Figure 5](#):

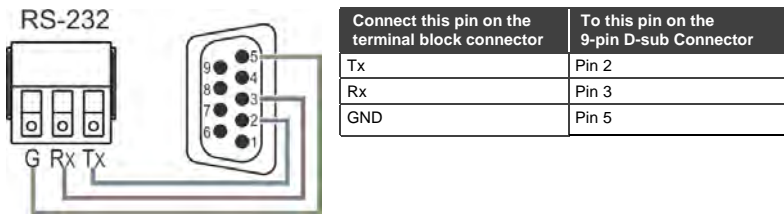

Figure 5: RS-232 Pinout

6.5 Performing a Factory Reset

Factory reset returns all the parameters of the device to their factory default settings.

To perform a factory reset:

1. Disconnect device power.
2. Press and hold INPUT 1 while reconnecting device power.
All indicators flash while resetting to the factory default parameters.
3. When all the lights turn off the reset is complete.

7 Technical Specifications

INPUTS:	4 HDMI connectors, 4 unbalanced stereo audio on 3.5mm mini jacks
ANALOG AUDIO UNBALANCED INPUT:	Nominal level: 316mVRMS, Maximum level: 1VRMS, Impedance: 10kΩ.
OUTPUTS:	1 HDMI connector, 1 balanced stereo audio on 5-pin terminal block
ANALOG AUDIO BALANCED OUTPUT:	Nominal level: 316mVRMS, Maximum level: 1VRMS, Impedance: 150Ω.
PORTS:	1 RS-232 on a 3-pin terminal block, 1 mini USB for programming
COMPLIANCE WITH HDMI STANDARD:	HDMI 1.4, Deep Color, 3D, ARC, up to 7.1 uncompressed audio channels, CEC
MAX. DATA RATE:	8.91Gbps (2.97Gbps per graphic channel)
SUPPORTED RESOLUTIONS:	Up to 4K x 2K, 4K@60Hz (4:2:0)
CONTROLS:	Front panel buttons, contact closure, IR, RS-232 Protocol 3000
SOFTWARE SUPPORT:	Protocol 3000, EDID Designer, K-Upload
POWER CONSUMPTION:	5V DC, 500mA
OPERATING TEMPERATURE:	0° to +40°C (32° to 104°F)
STORAGE TEMPERATURE:	-40° to +70°C (-40° to 158°F)
HUMIDITY:	10% to 90%, RHL non-condensing
DIMENSIONS:	21.5cm x16.3cm x 4.4cm (8.4" x 6.4" x 7.2") W, D, H
WEIGHT:	0.89kg (1.96lbs) approx.
SHIPPING DIMENSIONS:	31.5cm x 21.2cm x 7.2cm (12.4" x 8.4" x 2.8") W, D, H
SHIPPING WEIGHT:	1.49kg (3.28lbs) approx.
INCLUDED ACCESSORIES:	Power adapter, IR remote control
OPTIONS:	RK-1 19" rack adapter
Specifications are subject to change without notice at www.kramerav.com	

8 Supported Resolutions

Resolution	Refresh Rate
640 x 480p (59.95Hz is available on quantum 780B)	85Hz; 75Hz; 72Hz; 60Hz; 59.95Hz
720 x 480p	60Hz
720 x 576p	50Hz
800 x 600p	85Hz; 75Hz; 72Hz; 60Hz
848 x 480p	60Hz
852 x 480p (available on quantum 780B)	60Hz
1024 x 768p	85Hz; 75Hz; 70Hz; 60Hz
1280 x 960	60Hz
1280 x 1024p	75Hz; 60Hz
1280 x 768p (available on quantum 780B)	60Hz
1280x800p	60Hz
1920 x 1080p	50Hz; 60Hz; 30Hz; 24Hz;
1920 x 1080p	60Hz;
1920 x 1080i	50Hz; 60Hz;
1600 x 1200p	60Hz
1920 x 1200p	
1600 x 900p	60Hz
1152 x 864p	75Hz
1440 x 900p	60Hz
1680 x 1050p	60Hz
1360 x 768p	60Hz
1366 x 768	60Hz; 50Hz
1400 x 1050p	60Hz
720 x 480i (available on quantum 780B)	30Hz
3840 x 2160	30Hz; 25Hz; 24Hz; 60Hz 4:2:0
4096 x 2160	24Hz

9 Default Settings

The **VS-411UHD** has the following default settings for communication, first power on and EDID.

9.1 Default Communication Settings

RS-232	
Protocol 3000 (Default)	
Baud Rate	9600
Data Bits	8
Stop Bits	1
Parity	None
Command Format	ASCII

9.2 First Power On Default Settings

Parameter	Value
Out HDCP mode	Follow
Communication Format	KMR3000 (KMR device)
Close Output 5v Time	15sec
Current Input Source Port	Input port 1
Manual/Auto Switch Mode	Auto mode
Pr/Lc Switch Mode	Priority mode
ARC/De-embed Audio Out	DE-embed audio out
RS-232 Connection	CPU
Input Port HDCP	All ON
Kramer 3000 Model Name	'V', 'S', 'L', '4', '1', '1', 'U', 'H', 'D'
EDID	Default
USB for Virtual Com	Virtual Com
IP Address	192.168.1.39
Mask Number	255.255.0.0
Gateway Number	192.168.0.254
DHCP	Disabled (OFF)

9.3 Default EDID

Monitor

Model name..... VS-411UHD
Manufacturer..... KMR
Plug and Play ID..... KMR03ED
Serial number..... 1
Manufacture date..... 2015, ISO week 20
Filter driver..... None

EDID revision..... 1.3
Input signal type..... Digital (HDMI-a)
Color bit depth..... Undefined
Display type..... RGB color
Screen size..... 700 x 390 mm (31.5 in)
Power management..... Not supported
Extension blocs..... 1 (CEA-EXT)

DDC/CI..... Not supported

Color characteristics

Default color space..... Non-sRGB
Display gamma..... 2.20
Red chromaticity..... Rx 0.640 - Ry 0.341
Green chromaticity..... Gx 0.286 - Gy 0.610
Blue chromaticity..... Bx 0.146 - By 0.069
White point (default).... Wx 0.284 - Wy 0.293
Additional descriptors... None

Timing characteristics

Horizontal scan range.... 31-94kHz
Vertical scan range..... 50-85Hz
Video bandwidth..... 170MHz
CVT standard..... Not supported
GTF standard..... Not supported
Additional descriptors... None
Preferred timing..... Yes
Native/preferred timing.. 1280x720p at 60Hz
 Modeline..... "1280x720" 74.250 1280 1390 1430 1650 720 725 730 750 +hsync +vsync
Detailed timing #1..... 1920x1080p at 60Hz (16:9)
 Modeline..... "1920x1080" 148.500 1920 2008 2052 2200 1080 1084 1089 1125 +hsync +vsync

Standard timings supported

720 x 400p at 70Hz - IBM VGA
720 x 400p at 88Hz - IBM XGA2
640 x 480p at 60Hz - IBM VGA
640 x 480p at 67Hz - Apple Mac II
640 x 480p at 72Hz - VESA
640 x 480p at 75Hz - VESA
800 x 600p at 56Hz - VESA
800 x 600p at 60Hz - VESA
800 x 600p at 72Hz - VESA
800 x 600p at 75Hz - VESA
832 x 624p at 75Hz - Apple Mac II
1024 x 768i at 87Hz - IBM
1024 x 768p at 60Hz - VESA
1024 x 768p at 70Hz - VESA
1024 x 768p at 75Hz - VESA
1280 x 1024p at 75Hz - VESA
1152 x 870p at 75Hz - Apple Mac II
1280 x 720p at 60Hz - VESA STD
1280 x 800p at 60Hz - VESA STD
1440 x 900p at 60Hz - VESA STD
1280 x 960p at 60Hz - VESA STD
1280 x 1024p at 60Hz - VESA STD
1400 x 1050p at 60Hz - VESA STD
1680 x 1050p at 60Hz - VESA STD
1600 x 1200p at 60Hz - VESA STD

10 Protocol 3000

The **VS-411UHD** can be operated using the Kramer Protocol 3000 serial commands. The command framing varies according to how you interface with the **VS-411UHD**. For example, a basic video input switching command that routes a layer 1 video signal to HDMI out 1 from HDMI input 2 (`ROUTE 1, 1, 2`), is entered as follows:

- Terminal communication software, such as Hercules:

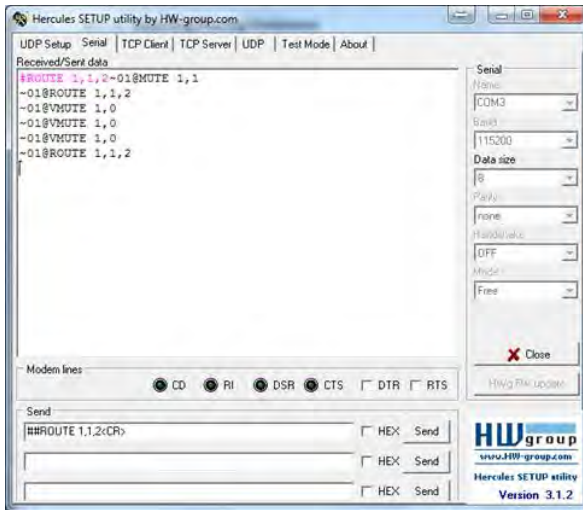

The framing of the command varies according to the terminal communication software. This command is used for demonstration purposes only and its syntax may vary per device.

- K-Touch Builder (Kramer software):

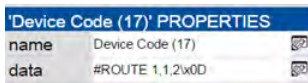



- As a driver in K-Config (Kramer configuration software):

```
"#ROUTE 1,1,2",0x0D
```

Set

Clear

You can enter commands directly using terminal communication software (e.g., Hercules) by connecting a PC to the serial port on the **VS-411UHD**. To enter  press the Enter key ( is also sent but is ignored by the command parser).

Commands sent from various non-Kramer controllers (e.g., Crestron) may require special coding for some characters (such as, /x##). For more information, refer to your controller's documentation.

For more information about:

- Using Protocol 3000 commands, see [Section 10.1](#)
- General syntax used for Protocol 3000 commands, see [Section 10.2](#)
- Protocol 3000 commands available for the **VS-411UHD**, see [Section 10.3](#)

10.1 Understanding Protocol 3000

Protocol 3000 commands are structured according to the following:

- **Command** – A sequence of ASCII letters (A–Z, a–z and –). A command and its parameters must be separated by at least one space.
- **Parameters** – A sequence of alphanumeric ASCII characters (0–9, A–Z, a–z and some special characters for specific commands). Parameters are separated by commas.
- **Message string** – Every command entered as part of a message string begins with a message starting character and ends with a message closing character.



A string can contain more than one command. Commands are separated by a pipe (|) character.

The maximum string length is 64 characters.

- **Message starting character:**
 - # – For host command/query

- ~ – For device response
- **Device address** – K-NET Device ID followed by @ (optional, K-NET only)
- **Query sign** – ? follows some commands to define a query request
- **Message closing character:**
 - `CR` – Carriage return for host messages (ASCII 13)
 - `CR LF` – Carriage return for device messages (ASCII 13) and line-feed (ASCII 10)
- **Command chain separator character** – Multiple commands can be chained in the same string. Each command is delimited by a pipe character (|). When chaining commands, enter the message starting character and the message closing character only at the beginning and end of the string.



Spaces between parameters or command terms are ignored. Commands in the string do not execute until the closing character is entered. A separate response is sent for every command in the chain.

10.2 Kramer Protocol 3000 Syntax

The Kramer Protocol 3000 syntax uses the following delimiters:

- **CR** = Carriage return (ASCII 13 = 0x0D)
- **LF** = Line feed (ASCII 10 = 0x0A)
- **SP** = Space (ASCII 32 = 0x20)

Some commands have short name syntax in addition to long name syntax to enable faster typing. The response is always in long syntax.

The Protocol 3000 syntax is in the following format:

- Host Message Format:

Start	Address (optional)	Body	Delimiter
#	<i>Device_id@</i>	Message	CR

- **Simple Command** – Command string with only one command without addressing:

Start	Body	Delimiter
#	Command SP <i>Parameter_1,Parameter_2,...</i>	CR

- **Command String** – Formal syntax with command concatenation and addressing:

Start	Address	Body	Delimiter
#	<i>Device_id@</i>	Command_1 <i>Parameter1_1,Parameter1_2,...</i> Command_2 <i>Parameter2_1,Parameter2_2,...</i> Command_3 <i>Parameter3_1,Parameter3_2,...</i> ...	CR

- Device Message Format:

Start	Address (optional)	Body	Delimiter
~	<i>Device_id@</i>	Message	CR LF

- Device Long Response – Echoing command:

Start	Address (optional)	Body	Delimiter
~	<i>Device_id@</i>	Command SP [<i>Param1,Param2 ...</i>] result	CR LF

10.3 Protocol 3000 Commands

This section includes the following commands:

- System Commands Mandatory (see [Section 10.3.1](#))
- System Commands (see [Section 10.3.2](#))
- Switching/Routing Commands (see [Section 10.3.3](#))
- EDID Handling Commands (see [Section 10.3.4](#))

10.3.1 System Commands - Mandatory

Command	Description
#	Protocol handshaking (system mandatory)
BUILD-DATE	Get device build date (system mandatory)
FACTORY	Reset to factory default configuration
HELP	Get command list (system mandatory)
MODEL	Get device model (system mandatory)
PROT-VER	Get device protocol version (system mandatory)
RESET	Reset device (system mandatory)
SN?	Get device serial number (system mandatory)
VERSION	Get device firmware version (system mandatory)

10.3.1.1

Functions		Permission	Transparency
Set:	#	End User	Public
Get:	-	-	-
Description		Syntax	
Set:	Protocol handshaking	# CR	
Get:	-	-	
Response			
~ nn @ SE OK CR LF			
Notes			
Validates the Protocol 3000 connection and gets the machine number Step-in master products use this command to identify the availability of a device			
K-Config Example			
"#", 0x0D			

10.3.1.2 BUILD-DATE

Functions		Permission	Transparency
Set:	BUILD-DATE	End User	-
Get:	-	-	-
Description		Syntax	
Set:			
Get:	Get device build date	#BUILD-DATE? CR	
Response			
~ hh @BUILD-DATE SP date SE time CR LF			
Parameters			
<i>date</i> – Format: YYYY/MM/DD where YYYY = Year, MM = Month, DD = Day <i>time</i> – Format: hh:mm:ss where hh = hours, mm = minutes, ss = seconds			
K-Config Example			
Read the device build date: "#BUILD-DATE? ", 0x0D			

10.3.1.3 FACTORY

Functions		Permission	Transparency
Set:	FACTORY	End User	Public
Get:	-	-	-
Description		Syntax	
Set:	Reset device to factory defaults configuration	#FACTORY CR	
Get:	-	-	
Response			
~ hh @FACTORY SP OK CR LF			
Notes			
This command deletes all user data from the device. The deletion can take some time. Your device may require powering off and powering on for the changes to take effect.			
K-Config Example			
Reset the device to its factory default configuration: "#FACTORY" , 0x0D			

10.3.1.4 HELP

Functions		Permission	Transparency
Set:	-	-	-
Get:	HELP	End User	Public
Description		Syntax	
Set:	-	-	
Get:	Get command list or help for specific command	#HELP <code>[CR]</code>	
Response			
1. Multi-line: ~ <code>[nn]</code> @Device available protocol 3000 commands: <code>[CR LF]</code> command, <code>[SP]</code> command... <code>[CR LF]</code>			
Parameters			
<i>COMMAND_NAME</i> – name of a specific command			
Notes			
To get help for a specific command use: HELP <code>[SP]</code> COMMAND_NAME <code>[CR LF]</code>			
K-Config Example			
"#HELP", 0x0D			

10.3.1.5 MODEL

Functions		Permission	Transparency
Set:	-	-	-
Get:	MODEL?	End User	Public
Description		Syntax	
Set:	-	-	
Get:	Get device model	#MODEL? <code>[CR]</code>	
Response			
~ <code>[nn]</code> @MODEL <code>[SP]</code> model_name <code>[CR LF]</code>			
Parameters			
<i>model_name</i> – String of up to 19 printable ASCII chars			
Notes			
This command identifies equipment connected to Step-in master products and notifies of identity changes to the connected equipment. The Matrix saves this data in memory to answer REMOTE-INFO requests			
K-Config Example			
Get device model: "#MODEL?", 0x0D			

10.3.1.6 PROT-VER

Functions		Permission	Transparency
Set:	-	-	-
Get:	PROT-VER?	End User	Public
Description		Syntax	
Set:	-	-	
Get:	Get protocol version	PROT-VER? <input type="checkbox"/>	
Response			
~ <input type="checkbox"/> @PROT-VER? <input type="checkbox"/> 3000:version <input type="checkbox"/> <input type="checkbox"/>			
Parameters			
version – Format: XX.XX where X is a decimal digit			
K-Config Example			
Get the protocol version: "#PROT-VER?", 0x0D			

10.3.1.7 RESET

Functions		Permission	Transparency
Set:	RESET	Administrator	Public
Get:	-	-	-
Description		Syntax	
Set:	Reset device	#RESET <input type="checkbox"/>	
Get:	-	-	
Response			
~ <input type="checkbox"/> @RESET? <input type="checkbox"/> OK <input type="checkbox"/> <input type="checkbox"/>			
Notes			
To avoid locking the port due to a USB bug in Windows, disconnect USB connections immediately after running this command. If the port was locked, disconnect and reconnect the cable to reopen the port.			
K-Config Example			
Reset the device: "#RESET", 0x0D			

10.3.1.8 SN

Functions		Permission	Transparency
Set:	-	-	-
Get:	SN?	End User	Public
Description		Syntax	
Set:	-	-	
Get:	Get device serial number	#SN?	CR
Response			
~nn@SNSEserial_numberCR LF			
Parameters			
serial_number – 14 decimal digits, factory assigned			
K-Config Example			
Get device serial number: "#SN?", 0x0D			

10.3.1.9 VERSION

Functions		Permission	Transparency
Set:	-	-	-
Get:	VERSION?	End User	Public
Description		Syntax	
Set:	-	-	
Get:	Get version number	#VERSION?	CR
Response			
~nn@VERSIONSEffirmware_versionCR LF			
Parameters			
firmware_version – format: XX.XX.XX.XXXX where the digits group are: major, minor, build, revision			
K-Config Example			
Get the firmware version number: "#VERSION?", 0x0D			

10.3.2 System Commands

Command	Description
HDCEP-MOD	Set/get HDCP mode
HDCEP-STAT?	Get HDCP signal status
LOCK-FP	Set/get front panel lock
UART	Set/get comm port configuration

10.3.2.1 HDCEP-MOD

Functions		Permission	Transparency
Set:	HDCEP-MOD	Administrator	Public
Get:	HDCEP-MOD?	End User	System
Description		Syntax	
Set:	Set HDCP mode	#HDCEP-MOD SP <i>inp_id</i> mode CR	
Get:	Get HDCP mode	#HDCEP-MOD? SP <i>stage_id</i> CR	
Response			
Set / Get: ~ nn @HDCEP-MOD SP <i>stage_id</i> mode CR LF			
Parameters			
<i>inp_id</i> - input number: 1 . . (max number of inputs)			
<i>mode</i> - HDCP mode: 0 (HDCP OFF), 1 (HDCP ON)			
Response triggers			
Response is sent to the com port from which the Set (before execution) / Get command was received			
Response is sent to all com ports after execution if HDCEP-MOD was set by any other external control device (button press, device menu and similar) or HDCP mode changed			
Notes			
Set HDCP working mode on device input :			
HDCP supported – HDCP ON [default]			
HDCP not supported – HDCP OFF			
HDCP support changes following detected sink – MIRROR OUTPUT			
K-Config Example			
Set HDCP mode on HDMI 1 on: "#HDCEP-MOD 1,1",0x0D			

10.3.2.2 HDCP-STAT

Functions		Permission	Transparency
Set:	-	-	-
Get:	HDCP-STAT?	End User	Public
Description		Syntax	
Set:	-	-	
Get:	Get HDCP signal status	#HDCP-STAT? <u>SP</u> stage,stage_id <u>CR</u>	
Response			
~ <u>nn</u> @HDCP-STAT <u>SP</u> stage,stage_id,mode <u>CR LF</u>			
Parameters			
<i>stage</i> - 0 (input), 1 (output) <i>stage_id</i> - for input stage: 1 (Input 1 HDMI), 2 (Input 2 HDMI), for output stage: 1 (HDMI Out) <i>actual_status</i> - HDCP signal encryption status: 0 (Off), 1 (On), 2 (Follow input), 3 (Mirror output - MAC mode)			
Response Triggers			
A response is sent to the comm port from which the Get command was received			
Notes			
Output stage (1) - get the HDCP signal status of the sink device connected to HDMI Out Input stage (0) - get the HDCP signal status of the source device connected to the specified input			
K-Config Example			
Get the HDCP input signal status of the source device connected to Input 1 HDMI: "#HDCP-STAT? 0,1",0x0D			

10.3.2.1 LOCK-FP

Functions		Permission	Transparency
Set:	LOCK-FP	End User	-
Get:	LOCK-FP?	End User	System
Description		Syntax	
Set:	Lock front panel	#LOCK-FP <u>SP</u> P1 <u>CR</u>	
Get:	Get front panel lock state	#LOCK-FP? <u>CR</u>	
Response			
~ <u>nn</u> @LOCK-FP <u>SP</u> P1 <u>SP</u> OK <u>CR LF</u>			
Parameters			
P1 - 0 (No) 1 (Yes)			
K-Config Example			
Lock the front panel: "#LOCK-FP 1",0x0D			

10.3.2.1 UART

Command Name		Permission	Transparency
Set:	UART	Administrator	Public
Get:	UART?	End User	Public
Description		Syntax	
Set:	Set comm port configuration	#UART _{SP} Com_Num,Baud_Rate,Data_Bit,Parity,Stop_Bit _{CR}	
Get:	Get comm port configuration	#UART? _{SP} Com_Num _{CR}	
Response			
Set: ~ _{nn} @UART _{SP} ComNum,BaudRate,DataBit,Parity,StopBit _{CR LF}			
Get: ~ _{nn} @UART? _{SP} ComNum,BaudRate,DataBit,Parity,StopBit,SerialType _{CR LF}			
Parameters			
COM_Num - 1 (RS-232 terminal block)			
baud_rate - 9600 - 115200			
data_bit - 7, 8			
parity - 0 (No), 1 (Odd), 2 (Even), 3 (Mark), 4 (Space)			
stop_bit - 1, 2			
serial_type - 232			
Response Triggers			
Notes			
K-Config Example			
Set the RS-232 terminal block to 115200 baud rate, 8 data bits, no parity, 1 stop bit: "#UART 1,115200,8,N,1",0x0D			

10.3.3 Switching Commands

Command	Description
DISPLAY?	Get output HPD status
MTX-MODE	Set/get auto-switch mode
VID	Set/get video switch state

10.3.3.1 DISPLAY

Functions		Permission	Transparency
Set:	-	-	-
Get	DISPLAY?	End User	Public
Description		Syntax	
Set:	-	-	
Get:	Get output HPD status	#DISPLAY? <u>S</u> <u>F</u> out_id <u>C</u> <u>R</u>	
Response			
- <u>m</u> @DISPLAY <u>S</u> <u>F</u> out_id,status <u>C</u> <u>R</u> <u>L</u> <u>F</u>			
Parameters			
out_id - 1 (HDMI Out)			
status - HPD status according to signal validation : 0 (Off), 1 (On), 2 (On and all parameters are stable and valid)			
Response Triggers			
A response is sent to the comm port from which the Get was received, after command execution and: After every change in output HPD status from On to Off (0) After every change in output HPD status from Off to On (1) After every change in output HPD status form Off to On and all parameters (new EDID, etc.) are stable and valid (2)			
Notes			
K-Config Example			
Get the output HPD status of HDMI Out: "#DISPLAY? 1",0x0D			

10.3.3.1 MTX-MODE

Functions		Permission	Transparency
Set:	MTX-MODE	End User	Public
Get:	MTX-MODE?	End User	Public
Description		Syntax	
Set:	Set auto-switch mode	#MTX-MODE	[SP]output_id,mode[CR]
Get :	Get auto-switch mode	#MTX-MODE?	[SP]output_id[CR]
Response			
~nn@MTX-MODE[SP]output_id,mode[CR]			
Parameters			
output_id - 1 (HDMI Out) mode - 0 (manual), 1 (auto priority), 2 (auto last connected)			
Response Triggers			
After execution, a response is sent to the comm port from which the Set/Get was received After execution, a response is sent to all comm ports if MTX-MODE was set by any other external control device (button press, WEB, device menu and similar)			
Notes			
Not recommended for new devices			
K-Config Example			
Set the auto switch mode of HDMI Out to last connected input: "#MTX-MODE 1,2",0x0D			

10.3.3.2 VID

Functions		Permission	Transparency
Set:	VID	End User	Public
Get:	VID?	End User	Public
Description		Syntax	
Set:	Set video switch state	#VID[SP]in>out[CR]	
Get:	Get video switch state	#VID?[SP]out[CR]	
Response			
Set:	~nn@VID[SP]in>out[CR LF]		
Get:	~nn@VID[SP]in>out[CR LF]		
Parameters			
<i>in</i> – 0 (disconnect output), 1 (Input 1 HDMI), 2 (Input 2 HDMI) > – Connection character between in and out parameters <i>out</i> – 1 (HDMI Out), * (all outputs)			
Response Triggers			
Notes			
The GET command identifies input switching on Step-in clients New Step-in modules support the ROUTE command			
K-Config Example			
Set the video switch state of HDMI Out to HDMI INPUT 1: "#VID 1>1",0x0D			

10.3.4 EDID Handling Commands

Command	Description
CPEDID	Copy EDID data from the output to the input EEPROM
GEDID	Set/get EDID data
LDEDID	Load EDID data

10.3.4.1 CPEDID

Functions		Permission	Transparency
Set:	CPEDID	End User	Public
Get:	-	-	-
Description		Syntax	
Set:	Copy EDID data from the output to the input EEPROM	#CPEDID SP <i>src_type, src_id, dst_type, dest_bitmap</i> CR	
Get:	-	-	
Response			
~ nm @CPEDID SP <i>src_type, src_id, dst_type, dest_bitmap</i> CR LF			
Parameters			
<i>src_type</i> – EDID source type (usually output): 1 (output), 2 (default EDID) <i>src_id</i> – for output source: 1 (HDMI Out), for default EDID source: 1 (default EDID) <i>dst_type</i> – EDID destination type (usually input): 0 (input) <i>dest_bitmap</i> – destination input to which the EDID data is copied: 0x1 (Input 1 HDMI), 0x2 (Input 2 HDMI), 0x3 (Input 3 HDMI), 0x4 (Input 4 HDMI)			
Response Triggers			
Response is sent to the comm port from which the Set was received (before execution)			
Notes			
K-Config Example			
Copy the EDID data from the HDMI Out output (EDID source) to the Input 1 HDMI: "#CPEDID 1,1,0,0x1",0x0D Copy the EDID data from the default EDID source to Input 2 HDMI: "#CPEDID 2,1,0,0x2",0x0D			

10.3.4.2 GEDID

Command Name		Permission	Transparency
Set:	GEDID	Administrator	Public
Get:	-	-	-
Description		Syntax	
Set:	Set EDID data from device	#GEDID <code>sp</code> stage,stage_id <code>cr</code>	
Get:	-	-	
Response			
Set:			
Multi-line response:			
~nn@GEDID <code>sp</code> stage,stage_id,size <code>CR LF</code>			
EDID_data <code>CR LF</code>			
~nn@GEDID <code>sp</code> stage,stage_id <code>sp</code> OK <code>CR LF</code>			
Parameters			
stage - input/output: 0 (input), 1 (output), 2 (default EDID)			
stage_id - number of chosen stage (1.. max number of inputs/outputs)			
size - EDID data size. For Set, size of data to be sent from device, for Get, 0 means no EDID support			
Response Triggers			
Response is sent to the comm port from which the Set (before execution) / Get command was received			
Notes			
For Get, size=0 means EDID is not supported			
For old devices that do not support this command, ~nn@ERR 002 <code>cr LF</code> is received			
K-Config Example			
Set the EDID data (size x) from the HDMI Out 1: "#GEDID 1,1",0x0D			

10.3.4.3 LDEDID

Command Name		Permission	Transparency
Set:	LDEDID	End User	Public
Get:	-	-	-
Description		Syntax	
Set:	Write EDID data from external application to device	Multi-step syntax (see following steps)	
Get:	-	-	
Communication Steps (Command and Response)			
Step 1: #LDEDID <code>[SP]</code> <i>dst_type</i> , <i>dest_bitmask</i> , <i>size</i> , <i>safe_mode</i> <code>[CR]</code>			
Response 1: ~ <code>[nn]</code> @LDEDID <code>[SP]</code> <i>dst_type</i> , <i>dest_bitmask</i> , <i>size</i> , <i>safe_mode</i> <code>[SP]</code> READY <code>[CR LF]</code> or ~ <code>[nn]</code> @LDEDID <code>[SP]</code> ERR <code>[nn]</code> <code>[CR LF]</code>			
Step 2: If ready was received, send <code>[EDID_DATA]</code>			
Response 2: ~ <code>[nn]</code> @LDEDID <code>[SP]</code> <i>dst_type</i> , <i>dest_bitmask</i> , <i>size</i> , <i>safe_mode</i> <code>[SP]</code> OK <code>[CR LF]</code> or ~ <code>[nn]</code> @LDEDID <code>[SP]</code> ERR <code>[nn]</code> <code>[CR LF]</code>			
Parameters			
<i>dst_type</i> - EDID destination type - 0 (input)			
<i>dest_bitmask</i> - (see table below) bitmap representing destination IDs. The binary presentation of this number is a bit mask for destinations. Setting '1' means EDID data has to be copied to this destination			
<i>size</i> - EDID data size (see table below)			
<i>safe_mode</i> - 0 (device accepts the EDID as is without trying to adjust <code>[EDID_DATA]</code> - data in protocol packets)			
<i>dest_bitmask</i>	<i>size</i>	<i>dest_bitmask</i>	<i>size</i>
0x01=HDMI1	256	0x40=HDBT1	256
0x02=HDMI2	256	0x80=HDBT2	256
0x04=HDMI3	256	0x100=HDBT3	256
0x08=HDMI4	256	0x200=HDBT4	256
0x10=HDMI5	256	0x01=PC	128
0x20=HDMI6	256		
Response Triggers			
Response is sent to the comm port from which the Set (before execution)			
Notes			
When the unit receives the LDEDID command it replies with READY and enters the special EDID packet wait mode. In this mode the unit can receive only packets and not regular protocol commands. If the unit does not receive correct packets for 30 seconds or is interrupted for more than 30 seconds before receiving all packets, it sends timeout error ~ <code>[nn]</code> @LDEDID <code>[SP]</code> ERR01 <code>[CR LF]</code> and returns to the regular protocol mode. If the unit received data that is not a correct packet, it sends the corresponding error and returns to the regular protocol mode.			
K-Config Example			
Write EDID to input1: "#LDEDID 0,0x01,256,1",0x0D			

LIMITED WARRANTY

The warranty obligations of Kramer Electronics for this product are limited to the terms set forth below:

What is Covered

This limited warranty covers defects in materials and workmanship in this product.

What is Not Covered

This limited warranty does not cover any damage, deterioration or malfunction resulting from any alteration, modification, improper or unreasonable use or maintenance, misuse, abuse, accident, neglect, exposure to excess moisture, fire, improper packing and shipping (such claims must be presented to the carrier), lightning, power surges, or other acts of nature. This limited warranty does not cover any damage, deterioration or malfunction resulting from the installation or removal of this product from any installation, any unauthorized tampering with this product, any repairs attempted by anyone unauthorized by Kramer Electronics to make such repairs, or any other cause which does not relate directly to a defect in materials and/or workmanship of this product. This limited warranty does not cover cartons, equipment enclosures, cables or accessories used in conjunction with this product.

Without limiting any other exclusion herein, Kramer Electronics does not warrant that the product covered hereby, including, without limitation, the technology and/or integrated circuit(s) included in the product, will not become obsolete or that such items are or will remain compatible with any other product or technology with which the product may be used.

How Long Does this Coverage Last

Seven years as of this printing; please check our Web site for the most current and accurate warranty information.

Who is Covered

Only the original purchaser of this product is covered under this limited warranty. This limited warranty is not transferable to subsequent purchasers or owners of this product.

What Kramer Electronics will do

Kramer Electronics will, at its sole option, provide one of the following three remedies to whatever extent it shall deem necessary to satisfy a proper claim under this limited warranty:

1. Elect to repair or facilitate the repair of any defective parts within a reasonable period of time, free of any charge for the necessary parts and labor to complete the repair and restore this product to its proper operating condition. Kramer Electronics will also pay the shipping costs necessary to return this product once the repair is complete.
2. Replace this product with a direct replacement or with a similar product deemed by Kramer Electronics to perform substantially the same function as the original product.
3. Issue a refund of the original purchase price less depreciation to be determined based on the age of the product at the time remedy is sought under this limited warranty.

What Kramer Electronics will not do Under This Limited Warranty

If this product is returned to Kramer Electronics or the authorized dealer from which it was purchased or any other party authorized to repair Kramer Electronics products, this product must be insured during shipment, with the insurance and shipping charges prepaid by you. If this product is returned uninsured, you assume all risks of loss or damage during shipment. Kramer Electronics will not be responsible for any costs related to the removal or re-installation of this product from or into any installation. Kramer Electronics will not be responsible for any costs related to any setting up this product, any adjustment of user controls or any programming required for a specific installation of this product.

How to Obtain a Remedy under this Limited Warranty

To obtain a remedy under this limited warranty, you must contact either the authorized Kramer Electronics reseller from whom you purchased this product or the Kramer Electronics office nearest you. For a list of authorized Kramer Electronics resellers and/or Kramer Electronics authorized service providers, please visit our web site at www.kramerelectronics.com or contact the Kramer Electronics office nearest you.

In order to pursue any remedy under this limited warranty, you must possess an original, dated receipt as proof of purchase from an authorized Kramer Electronics reseller. If this product is returned under this limited warranty, a return authorization number, obtained from Kramer Electronics, will be required. You may also be directed to an authorized reseller or a person authorized by Kramer Electronics to repair the product.

If it is decided that this product should be returned directly to Kramer Electronics, this product should be properly packed, preferably in the original carton, for shipping. Cartons not bearing a return authorization number will be refused.

Limitation on Liability

THE MAXIMUM LIABILITY OF KRAMER ELECTRONICS UNDER THIS LIMITED WARRANTY SHALL NOT EXCEED THE ACTUAL PURCHASE PRICE PAID FOR THE PRODUCT. TO THE MAXIMUM EXTENT PERMITTED BY LAW, KRAMER ELECTRONICS IS NOT RESPONSIBLE FOR DIRECT, SPECIAL, INCIDENTAL OR CONSEQUENTIAL DAMAGES RESULTING FROM ANY BREACH OF WARRANTY OR CONDITION, OR UNDER ANY OTHER LEGAL THEORY. Some countries, districts or states do not allow the exclusion or limitation of relief, special, incidental, consequential or indirect damages, or the limitation of liability to specified amounts, so the above limitations or exclusions may not apply to you.

Exclusive Remedy

TO THE MAXIMUM EXTENT PERMITTED BY LAW, THIS LIMITED WARRANTY AND THE REMEDIES SET FORTH ABOVE ARE EXCLUSIVE AND IN LIEU OF ALL OTHER WARRANTIES, REMEDIES AND CONDITIONS, WHETHER ORAL OR WRITTEN, EXPRESS OR IMPLIED. TO THE MAXIMUM EXTENT PERMITTED BY LAW, KRAMER ELECTRONICS SPECIFICALLY DISCLAIMS ANY AND ALL IMPLIED WARRANTIES, INCLUDING, WITHOUT LIMITATION, WARRANTIES OF MERCHANTABILITY AND FITNESS FOR A PARTICULAR PURPOSE. IF KRAMER ELECTRONICS CANNOT LAWFULLY DISCLAIM OR EXCLUDE IMPLIED WARRANTIES UNDER APPLICABLE LAW, THEN ALL IMPLIED WARRANTIES COVERING THIS PRODUCT, INCLUDING WARRANTIES OF MERCHANTABILITY AND FITNESS FOR A PARTICULAR PURPOSE, SHALL APPLY TO THIS PRODUCT AS PROVIDED UNDER APPLICABLE LAW.

IF ANY PRODUCT TO WHICH THIS LIMITED WARRANTY APPLIES IS A "CONSUMER PRODUCT" UNDER THE MAGNUSON-MOSS WARRANTY ACT (15 U.S.C.A. §2301, ET SEQ.) OR OTHER APPLICABLE LAW, THE FOREGOING DISCLAIMER OF IMPLIED WARRANTIES SHALL NOT APPLY TO YOU, AND ALL IMPLIED WARRANTIES ON THIS PRODUCT, INCLUDING WARRANTIES OF MERCHANTABILITY AND FITNESS FOR THE PARTICULAR PURPOSE, SHALL APPLY AS PROVIDED UNDER APPLICABLE LAW.

Other Conditions

This limited warranty gives you specific legal rights, and you may have other rights which vary from country to country or state to state.

This limited warranty is void if (i) the label bearing the serial number of this product has been removed or defaced, (ii) the product is not distributed by Kramer Electronics or (iii) this product is not purchased from an authorized Kramer Electronics reseller. If you are unsure whether a reseller is an authorized Kramer Electronics reseller, please visit our Web site at www.kramerelectronics.com or contact a Kramer Electronics office from the list at the end of this document.

Your rights under this limited warranty are not diminished if you do not complete and return the product registration form or complete and submit the online product registration form. Kramer Electronics thanks you for purchasing a Kramer Electronics product. We hope it will give you years of satisfaction.

KRAMER



P/N: 2900-300537



Rev: 1



SAFETY WARNING

Disconnect the unit from the power supply before opening and servicing

For the latest information on our products and a list of Kramer distributors, visit our Web site to find updates to this user manual.

We welcome your questions, comments, and feedback.

www.KramerAV.com
info@KramerAV.com